

# CMT ORANGE TOOLS®

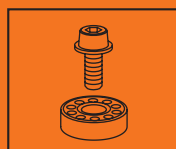

## 2024 EDITION USA / CAN CATALOG

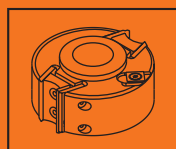

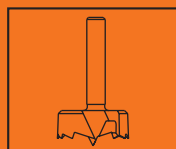
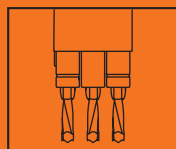
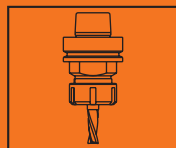
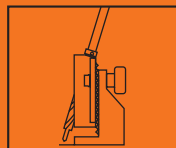
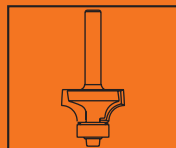
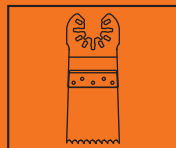
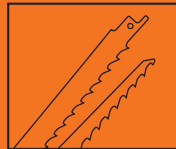
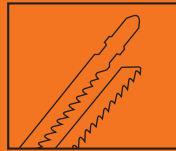
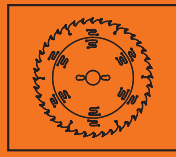

## SAW BLADES

5~87



## RECIPROCATING SAW BLADES

88~100



## JIG SAW BLADES

101~107



## TOOLS FOR MULTI-CUTTERS

109~134

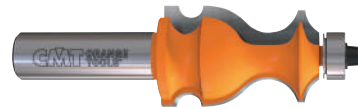

## ROUTER BITS & SETS

135~248



## JIGS & ACCESSORIES

249~268



## CNC ROUTER BITS & CHUCKS

269~286



## DOWEL DRILLS

287~300



## BORING BITS

301~305



## HOLE SAWS

306~318



## CUTTER HEADS & KNIVES

319~353



## SPARE PARTS

354~356





# Blade & Chart Abbreviations

## BLADE CHART ABBREVIATIONS

- B** = Bore Diameter
- D** = Diameter
- K** = Kerf Thickness
- P** = Plate Thickness
- PH** = Pin Hole
- PITCH T** =  $(D \cdot 3.14) / Z$
- RPM** = Round per Minute
- T** = N° of Teeth
- V** = N° of Rakers

- $\alpha$  = Hook Angle
- $\beta$  = Type of Grind:
  - ATB** = Alternate Top Bevel Grind
  - CO / CONICAL** = Conical Teeth
  - FFT** = Flat Flat Trapezoidal
  - FLAT / FTG** = Flat Top Grind
  - FWF** = Flat with Alternate Chamfer
  - HDF** = Hollow Ground Teeth
  - Hi-ATB** = High Alternate Top Bevel Grind
  - HR** = Hollow Back Tooth Configuration
  - MATB** = Alternate Top Bevel with Chamfer Grind
  - MTCG** = Triple Chip Grind (Trapezoidal) with Chamfer
  - TCG** = Triple Chip Grind (Trapezoidal)

## CHART ABBREVIATIONS

- $\alpha$  = Axial Angle
- A** = Angle
- B** = Bore Diameter
- D / D<sub>2</sub> / d** = Diameter
- H** = Cutting Depth
- I / I<sub>1</sub>** = Cutting Length
- K** = Thickness
- L** = Overall Length
- LB** = Relative Length
- R / R<sub>1</sub>** = Radius
- RPM** = Round per Minute
- S** = Shank Diameter
- T** = N° of Teeth
- T<sub>1</sub>** = Workable Thickness
- TPI** = Teeth per Inch
- TS** = Tooth Spacing
- V** = N° of Spurs
- W** = Width
-  = Dispatch Package Q.ty

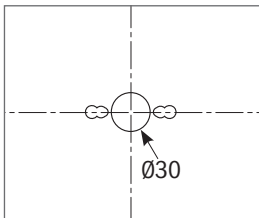

**COMBI3**  
2/7/42mm  
2/9/46.4mm  
2/10/60mm

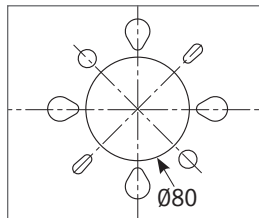

**COMBI5**  
2/7/110mm  
2/8.4/130mm  
2/14/110mm  
4/9/100mm  
4/19/120mm

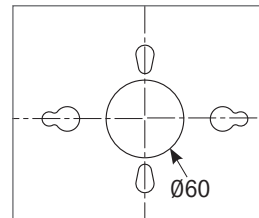

**COMBI7**  
2/10/80mm  
1/11/85mm  
2/11/115mm  
2/11/148mm  
2/14/100mm  
2/14/125mm  
2/19/120mm

## THE RIGHT TOOLS FOR THE BEST RESULTS!

Quick reference charts and pictograms help you choose the right tools for your application.

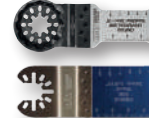

	SAW BLADES	JIG SAW BLADES	SABRE SAW BLADES	MULTI-CUTTERS	HOLE SAWS
WOOD					CARBIDE
WOOD & METAL		✓	✓	✓	
METAL					BI-METAL
ALUMINUM					
MULTI-MATERIAL					
PLASTIC					
MASONRY					DIAMOND
SPECIAL					

**MADE IN ITALY  
SINCE 1962  
60 YEARS  
AND STILL  
GOING STRONG!**

By now, the story has been told. After over 60 years of success and quality in manufacturing woodworking tools - orange woodworking tools, to be precise - word just sort of gets around. We have grown and we have changed, but one thing still remains the same: our commitment to making only the highest quality woodworking tools.



**OUR BRANCHES**



Pesaro, Italy



Udine, Italy



Greensboro, United States



Valencia, Spain

**OUR TOOLS** So, what does it take to make a CMT tool? Like all things of quality, it's not only what you do but how you do it. And anyone who works wood knows that you get out of a piece only what you put into it, and it is no different when manufacturing a tool. You choose your designs and materials carefully and you work using all of your skill and know-how. You'll be happy to know that's what we do at CMT too.

**OUR TRADEMARK COLOR ORANGE**

As the story goes, we began small. We also put orange color surface coating on our tools, then we put our tools on the market and soon our orange tools were all over the world. Now, any woodworker anywhere in the world can tell you that orange tools means CMT, and that CMT means quality. Here at CMT we know we produce quality. You should too. That's why we have trademarked the color orange on woodworking tools - it's your guarantee that you are getting a genuine high-quality CMT product.

**DESIGN**

Everything starts with a clear idea and having the potential to express it. We have both. At CMT, our technical department uses the best of both worlds - computer technology and hands-on experience - to engineer and design each tool so that it performs flawlessly each time you use it, and to guarantee that you'll be using it for a long, long time.

**MATERIALS**

Turning a design into a finished product means finding the right material that will do the job and that lives up to the specifications set out in the design - quality performance from the final product depends on it. When it comes to selecting raw materials, we don't cut corners.

At CMT, we know that high quality tools come only from high quality raw materials, so we use only solid bar stock steel and specially formulated micrograin carbide to manufacture our bits and blades.



Loading the automated multi-axis CNC sharpening machines.





## Our Company



### MANUFACTURING

Like we said, it's not just what you do but how you do it. Over the years we have continuously invested in the latest technology in CNC machining equipment and innovative software to manufacture our tools. The result is that now our entire manufacturing process, from turning and milling the steel shanks to brazing and sharpening the carbide cutting tips, is completely automated. And since a machine is only as intelligent as the person using it, everything is operated by specifically trained operators.

### THE FINAL TOUCH

A tool simply wouldn't be a CMT tool if it didn't have the trademark orange color non-stick P.T.F.E. coating on it. This unique industrial strength surface coating is designed to withstand the physical stresses the tool undergoes during use while protecting it from residue build-up and burning. And we really like the orange color too.

### QUALITY CONTROL

Nobody's perfect, but we're trying. CMT uses rigorous quality control programs and the latest generation machining equipment to ensure that each bit has been manufactured with precision and accuracy and that it will give the long-lasting performance you expect from a **CMT ORANGE TOOL**. Our tools are manufactured in compliance with European Standard EN 847 published and enforced by the CEN (European Committee for Standardisation).



### WE RECYCLE

CMT filters and purifies its water using a reverse osmosis system located inside the plant. Also the oil used in grinding and machining our tools must be clean and absolutely free of contaminants. Clean oil, after enough use, gets dirty, so we filter and reprocess dirty oil on the premises. This is our way of guaranteeing the quality of the oil we use, as well as contributing to help protect the environment.

### LOGISTICS & SERVICES

CMT offers a wide product range with over 7000 different standard tools, but that still isn't enough to achieve 100% customer satisfaction. It's a top priority to process orders and ship the same day. That's why CMT factories worldwide are equipped with 20+ automated vertical storage systems programmed to expedite and simplify order and delivery.

The tools you need, in-stock and ready for prompt shipment within 24 hours. What does this translate to for customers? Quick and efficient service exceeding customer satisfaction and branding our success.



Pesaro, Italy



Greensboro, United States

### OUR CHANNELS



[www.cmtorangetools.com](http://www.cmtorangetools.com)



[www.youtube.com/user/cmtorangetools](https://www.youtube.com/user/cmtorangetools)



[www.facebook.com/cmt.italy](https://www.facebook.com/cmt.italy)



[www.instagram.com/cmt\\_orangetools](https://www.instagram.com/cmt_orangetools)

# Maximize Your Saw's Performance



BLADE RANGE	INDUSTRIAL CHROME®	INDUSTRIAL ORANGE SHIELD®	XTREME/ITK XTREME	ITK PLUS®	CMT CONTRACTOR TOOLS®
PERFORMANCE	★★★★★	★★★★★	★★★★★	★★★★	★★★
DESCRIPTION	Designed for professional woodworkers who require high precision and durability from their saw blades. Special chrome carbide reduces tooth abrasion, whereas the chrome plated body protects against rust, corrosion and guarantees long-lasting performance.	Designed for professional woodworkers and finish carpenters who run their blades all day long demanding ultimate precision and extended life, while conquering the most challenging applications.	Designed for the professional woodworker and construction craftsman, CMT's thin-kerf industrial quality blade line delivers an outstanding cut, minimal stock removal and the least possible stress to your saw!	Designed for professionals and remodelers, CMT's ITK PLUS® line delivers clean, fast and effortless cutting through wood and wood composites. A perfect balance of features and attractive price makes the ITK PLUS® line a great value.	Designed for the contractor and remodeler CMT's CONTRACTOR® thin-kerf blade line delivers solid performance at a very economical price. Ideal for any construction projects that require cutting wood and wood composite.
USER	PROFESSIONAL WOODWORKER	PROFESSIONAL WOODWORKER	PROFESSIONAL & CONTRACTOR	CONTRACTOR & REMODELER	CONTRACTOR & REMODELER
USAGE	RUN ALL DAY	RUN ALL DAY	HEAVY DAILY USE	DAILY USE	DAILY USE
PRICE POINT	PREMIUM	PREMIUM	UPPER MID	MID	VALUE
MATERIALS	Wood, Plywood, OSB, Laminate, Melamine, Moldings, MDF.	Wood, Plywood, OSB, Laminate, Melamine, Moldings, MDF.	Wood, Wood & Nails, Composite Decking, Plywood, OSB, Laminate, Melamine, Moldings, MDF, Non-Ferrous Metals.	Wood, Composite Decking, Plywood, OSB, Laminate, Melamine, MDF and Fiber Cement.	Wood, Composite Decking, Plywood, OSB, Laminate, Melamine, MDF.
STEEL PLATE	LASER-CUT PREMIUM QUALITY STEEL PLATE Made of 46-48 HRC precision German steel which is laser-cut to provide tighter tolerances ensuring longer life and more accurate cuts.	LASER-CUT PREMIUM QUALITY STEEL PLATE Made of 46-48 HRC precision German steel which is laser-cut to provide tighter tolerances ensuring longer life and more accurate cuts.	LASER-CUT PREMIUM QUALITY STEEL PLATE Made of 46-48 HRC precision German steel which is laser-cut to provide tighter tolerances ensuring longer life and more accurate cuts.	HEAVY-DUTY LASER CUT PLATE Made of a thin & strong plate, laser cut from the finest steel which is then hardened to 44 HRC to ensure a longer life and more accurate cuts.	HEAVY-DUTY STAMPED DIE CUT PLATE Made of a thin & strong plate cut from the finest steel which is then hardened to 44 HRC to ensure a longer life and more accurate cuts.
CARBIDE TEETH	<b>INDUSTRIAL CHROMIUM MICROGRAIN CARBIDE</b> Cutting teeth are made from a specially formulated chromium micrograin carbide which stays sharper longer by reducing cutting edge abrasion, improving cut quality and tool life.	<b>INDUSTRIAL CHROMIUM MICROGRAIN CARBIDE</b> Special formulated chromium micrograin carbide which stays sharper longer by reducing cutting edge abrasion, improving cut quality and tool life.	<b>INDUSTRIAL CHROMIUM MICROGRAIN CARBIDE</b> Cutting teeth are made from a specially formulated chromium micrograin carbide which stays sharper longer by reducing cutting edge abrasion, improving cut quality and tool life.	<b>INDUSTRIAL SINTERHIP HI-DENSITY CARBIDE</b> The new process SinterHIP (high temperature 3500°F and high pressure 1500 psi) creates a porosity-free and Hi-Density carbide which provides a longer cutting life than tradition carbide.	<b>LONG LASTING CONSTRUCTION GRADE CARBIDE</b> Specially formulated construction grade carbide which provides a longer cutting life and greater resistance to impact.
KERF	FULL KERF	FULL KERF	THIN-KERF	THIN-KERF	THIN-KERF
BRAZING	<b>TRI-METAL BRAZING</b> The Silver-Copper-Silver tri-metal brazing process lets the teeth withstand severe impact caused by cutting harder wood and composite material.	<b>TRI-METAL BRAZING</b> The Silver-Copper-Silver tri-metal brazing process lets the teeth withstand the severe impact caused by cutting harder woods and composite material.	<b>TRI-METAL BRAZING</b> The Silver-Copper-Silver tri-metal brazing process lets the teeth withstand the severe impact caused by cutting harder woods and composite material.	<b>SILVER BRAZING</b> The silver brazing process lets the teeth withstand the standard impact caused by cutting soft woods and composite material.	<b>SILVER BRAZING</b> The silver brazing process lets the teeth withstand the standard impact caused by cutting soft woods and composite material.
COATING	<b>CHROME® COATING</b> Blade plate is covered with a chrome layer to protect your tool against corrosion and rust, guaranteeing longer tool life.	<b>NON-STICK ORANGE SHIELD® COATING</b> Prevents overheating, protects against corrosion and rust, reduces resin build-up, reduces blade drag, and improves performance and cutting life.	<b>CHROME® COATING</b> Blade plate is covered with a chrome layer to protect your tool against corrosion and rust, guaranteeing longer tool life.	<b>NON-STICK ORANGE SHIELD® COATING</b> Keeps the blade running cool, reduces pitch build up and protects against corrosion. Ideal for all types of wood including wet lumber.	<b>HARD LACQUER</b> Protects against corrosion and rust.
EXPANSION SLOTS	<b>LASER-CUT HEAT EXPANSION SLOTS</b> Engineered to allow the blade to expand when heat build-up occurs from use, preventing blade warping.	<b>LASER-CUT HEAT EXPANSION SLOTS</b> Engineered to allow the blade to expand when heat build-up occurs from use, preventing blade warping.	<b>LASER-CUT HEAT EXPANSION SLOTS</b> Engineered to allow the blade to expand when heat build-up occurs from use, preventing blade warping.	<b>LASER-CUT HEAT EXPANSION SLOTS</b> Engineered to allow the blade to expand when heat build-up occurs from use, preventing blade warping.	<b>HEAT EXPANSION SLOTS</b> Engineered to allow the blade to expand when heat build-up occurs from use, preventing blade warping.
NOISE VIBRATION REDUCTION	<b>FILLED SLOTS</b>	<b>FILLED SLOTS</b>	<b>FILLED SLOTS</b>		
CMT XTREME BALANCING™	Unique patented dynamic balancing several orders of magnitude above and beyond that which is currently available in the marketplace	Unique patented dynamic balancing several orders of magnitude above and beyond that which is currently available in the marketplace	Unique patented dynamic balancing several orders of magnitude above and beyond that which is currently available in the marketplace	✗	✗
SOUND DAMPENING CHANNELS	<b>LASER-CUT SLOTS FILLED WITH SOUND-DAMPENING MATERIAL</b> Specifically designed to dampen running noise and control wobbling caused by unwanted harmonic vibration.	<b>LASER-CUT SOUND-DAMPENING CHANNELS</b> Specifically designed to dampen running noise and control wobbling caused by unwanted harmonic vibration.	<b>LASER-CUT SOUND-DAMPENING CHANNELS</b> Are specifically designed to dampen running noise and control wobbling caused by unwanted harmonic vibration.	<b>LASER-CUT SOUND-DAMPENING CHANNELS</b> Specifically designed to dampen running noise and control wobbling caused by harmonic vibration.	✗
TENSIONING RINGS	<b>TENSIONING RING</b> A visible tensioning ring on the blade provides stability while cutting and perfect concentricity during rotation.	<b>TENSIONING RING</b> A visible tensioning ring on the blade provides stability while cutting and perfect concentricity during rotation.	<b>TENSIONING RING</b> A visible tensioning ring on the blade provides stability while cutting and perfect concentricity during rotation.	✗	✗
SHARPENING	<b>PRECISION MIRROR FINISH SHARPENING</b> Each tooth is ground to razor sharp precision on a multi-axis CNC machine which creates perfect edge angles, guaranteeing extra-clean cuts and extended life. Featuring less than 0.25 µm Rmax in edge roughness.	<b>PRECISION MIRROR FINISH SHARPENING</b> Each tooth is ground to razor sharp precision on a multi-axis CNC machine which creates perfect edge angles, guaranteeing extra-clean cuts and extended life. Featuring less than 0.25 µm Rmax in edge roughness.	<b>PRECISION MIRROR FINISH SHARPENING</b> Each tooth is ground to razor sharp precision on a multi-axis CNC machine which creates perfect edge angle, guaranteeing extra-clean cuts and extended life. Featuring less than 0.25 µm Rmax in edge roughness.	<b>SHEAR ANGLE SHARPENING</b> The shear angle grind on the face front of each tooth produces smooth cuts, and reduces the cutting force needed thereby improving cutting speed and setting a new standard for performance.	<b>STANDARD SHARPENING</b> Each tooth is sharpened with accuracy to guarantee clean cuts and longer lifetime.
PAGE	10 ~ 44	10 ~ 44	45 ~ 58	59 ~ 77	79 ~ 87



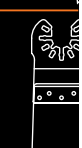
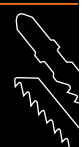

## NEW PRODUCTION FACILITY IN UDINE, ITALIA

We are honored to announce the appointment of Piergiorgio Pozzo as Head of the administrative team at our new and highly technological blade production plant based in Udine.

Mr. Pozzo's experience stems from a long-standing commitment to and success in the development of high-performance industrial blades.

Thanks to a rich and extensive knowledge in the field, Mr. Pozzo and his team have successfully patented a brand-new saw blade line of outstanding quality.



## QUALITY ACCORDING TO CMT

Quality can take on different meanings, at times it may relate to the appearance of a product, other times to the number of features or the materials used to make it and so on. Circular saw blades are technical items, tools dedicated to the realization of intermediate workings that if carried out impeccably, enable the manufacturing of the highest-quality finished products with the best production efficiency. Based on this principal, CMT manufactures saw blades using the functional quality concept, this being that every detail of the saw blade, from its design to the choice of materials to its manufacturing cycle, is finalized to give the best performance in the true-life use of the tool. As such, the features of our saw blades are always functional and are found on the product only if and when they bring a true benefit to reaching the established performance target. Should any of the saw blade features fail to do so they will be purposely omitted; the same applies to the tools' manufacturing work cycle which in turn makes it possible for CMT to focus its resources and on what really represents value for the user. The quality embedded in our products is the result of a school of thought which is shared and embraced by the people who make them, and this culture is relentlessly cultivated and improved. Quality at CMT also means respect for people and the Earth.

### STEEL PLATE

The body of a blade is an integral part of blade design; cutting quality and longevity depend on it. We use only the highest quality steel available, so durable and tough that it will not only withstand heavy workloads, but also be flexible enough to bend without breaking.

### LASER CUT

All our blanks are laser cut; this allows us to use harder harmonic steels for the blade bodies, which in return generates extremely rigid and stable saw blades, guaranteeing perfect flatness. In addition, we are able to engineer quieter tools using a very narrow laser beam to cut expansion and vibration dampening slots.

### EXPANSION SLOTS

Unique expansion slots permit the blade to stand up to heat build-up and centrifugal force thereby preventing plate deformation and warping for a cleaner finished cut.

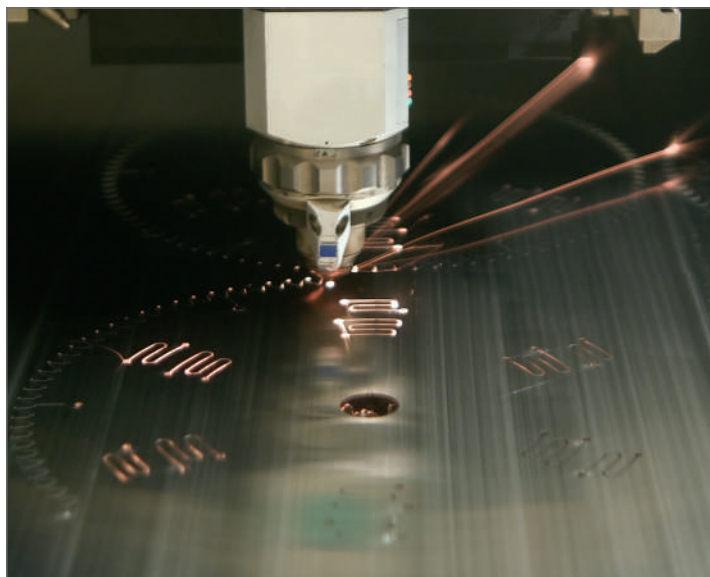

### NEW LASER-CUT SLOTS FILLED WITH SOUND-DAMPENING POLYMER

Slots filled with a sound-dampening polymer reducing vibration and noise by 25% with respect to standard saw blades.

Improved cutting quality and extended blade life.

Slots positioned near toothed crown provide impressive vibration isolation and shock absorption.

Fully compliant with National Noise Emission Standard & Regulation.



**FILLED SLOTS**

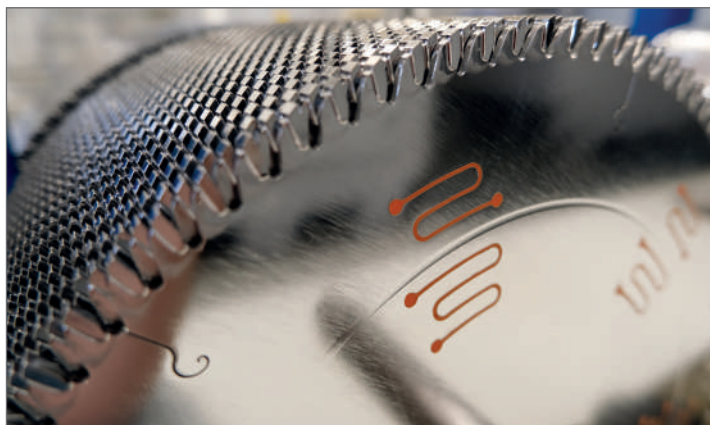

## CMT XTREME BALANCING™\*

\* TRADEMARK & INT. PAT. PEND.

This system allows for extremely accurate dynamic balancing of the blade, several orders of magnitude above and beyond that which is currently available in the marketplace. Each blade undergoes rigorous assessment and only in the event that micro imbalance is detected will the appropriate correction holes be applied. You may find 1 to 5 micro balancing holes on your blade, depending on the degree of micro imbalance (fig.1). When in perfect balance, a single incision will appear on the blade as proof of balance (fig.2).

These holes will have no effect on the technical properties of the blade during use (such as an increase in noise\*\*, chip build-up at the correction site, etc.). This translates to precise cutting, longer blade life, reduced vibration and noise, and less wear and tear on your machine components.

\*\*Results are based on tests conducted by an independent laboratory. These results are available for download on our website.

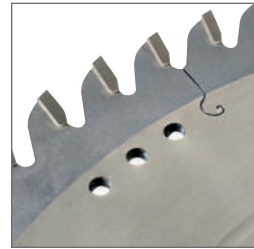
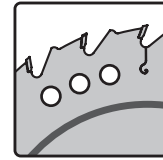

Fig. 1 Example of balancing holes.



Fig. 2 Example of inspected blade already in perfect balance.

**CMT XTREME  
BALANCING**



## TENSIONING RINGS & FLATTING

To ensure maximum performance, flattening and plate tensioning processes are performed. Every single blade is subject to a flattening process in order to achieve the highest flatness tolerance. The blade body then undergoes tensioning in order to enhance stiffness and stability. A well-marked and visible ring is applied to the blade body by means of compression and with a predetermined force linked to the intended application and working conditions of each blade.

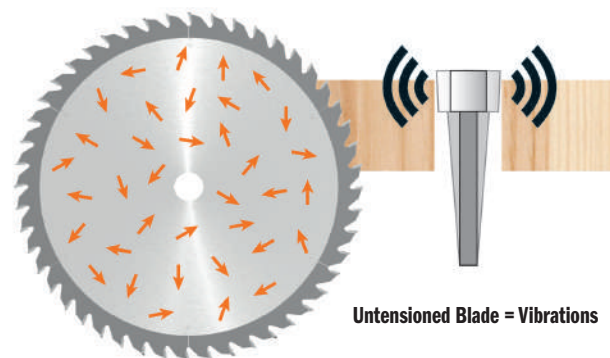
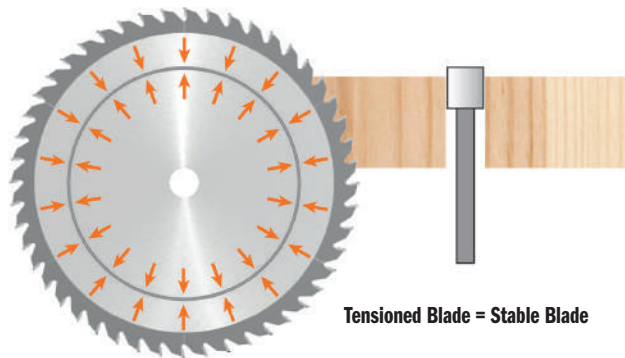

## CARBIDE TEETH

Tips require optimum quality carbide. Different applications call for different grades. Our Research and Development Team has evaluated and tested carbide grades and tracked their yield on performance both in house and in the field. We have access to the widest range in the world and only use top premium quality carbides.

## TRI-METAL BRAZING

Brazing is the process of attaching a hard metal plate to the steel body of the blade. This is performed by using a bonding metal, which once melted, acts as a binder between the two parts. The bonding material used for brazing is a trimetallic alloy formed by silver, copper and silver, which not only serves to effectively attach the two parts together but whose fundamental properties create a shock-absorber effect protecting the cutting edges during routing operations.

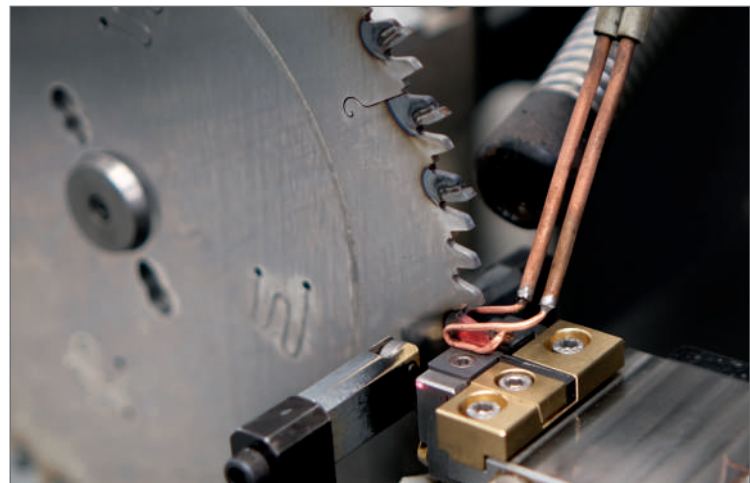
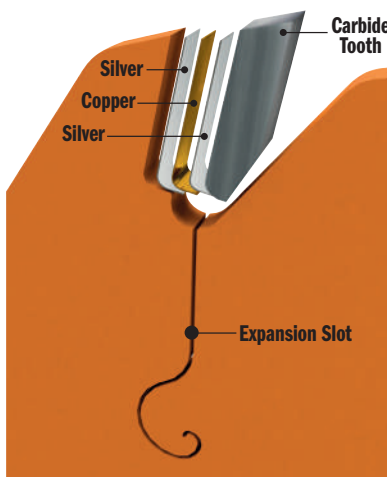



## SHARPENING & CUTTING ANGLES

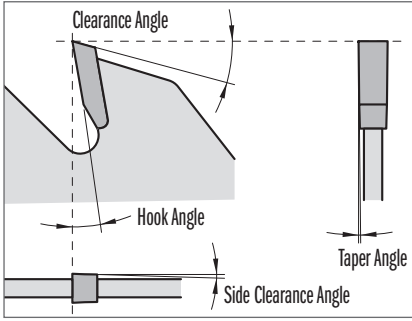

Sharpening is imperative to the production process of the blade and equally important with respect to the project in mind and material in use. Fully automated and numerically controlled grinding machines tooled with extra-fine-grained diamond wheels allow any type of angle and shape of the tooth. The right choice of these parameters will guarantee cutting edge lifetime and ultimately the best finish on the finished part.



## COATING

Quality coatings can be extremely effective in certain applications. CMT uses the following:



**ORANGE SHIELD® COATING:** a registered and trademarked non-stick protective coating bearing our characteristic orange color. A technopolymer (P.T.F.E.) is spray-applied to the blade body then baked to enhance its protective properties. Chemical compounds cannot attach this coating, it remains insoluble in water and solvents, is completely non-stick and diffuses and disperses heat.



**ORANGE CHROME®:** this is a coating composed of a thin layer of chromium, which is electrolytically deposited on the blade in order to increase wear resistance when in contact with highly abrasive material. Surface hardness increases considerably, guaranteeing long-life and incredible resilience to corrosion and rust.

## LASER MARKING & SCREEN PRINTING

All CMT blades are identifiable by means of a latest generation indelible laser marking or multicolored screen-printing, a sophisticated automated technology that guarantees striking and versatile results.

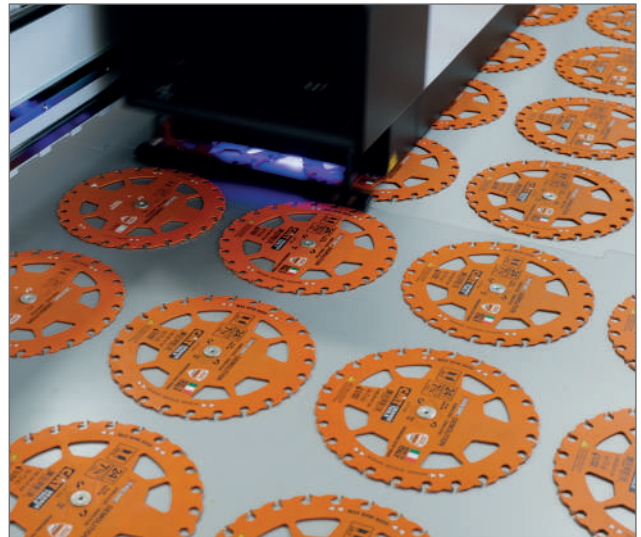

## FINAL TESTING AND QUALITY CONTROL

Following design and manufacturing phases, each new model is tested to ensure maximum performance during the work phase. The entire production process is subject to meticulous quality controls using conventional and sophisticated measuring system.



## NEW PACKAGING

- Blade packaging is made from strong and sturdy cardboard, reusable and environmentally friendly.
- Package information updated in 12 languages.
- New colored labels offer useful technical information such as application, materials and machine compatibility.

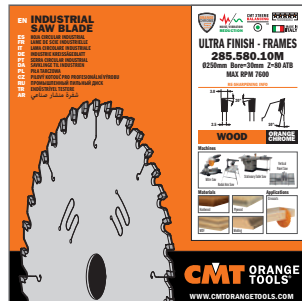





# INDUSTRIAL CHROME®

Designed for professional woodworkers who require high precision and durability from their saw blades. Special chrome carbide reduces tooth abrasion, whereas the chrome plated body protects against corrosion and pitch build-up, guaranteeing long-lasting performance.



## CHROME® COATING

Chrome plated blade:

- protects the tool against corrosion, rust and accumulation of resin and residues
- guarantees longer tool life
- power absorbed by motor is significantly reduced
- tool moves smoothly throughout cutting operation
- tool maintenance fast and easy
- surface hardness: 380/400 Vickers



- ★★★★★ INDUSTRIAL CHROME®
- ★★★★★ INDUSTRIAL ORANGE SHIELD®
- ★★★★★ ITK XTREME
- ★★★★ ITK PLUS®
- ★★★ CMT CONTRACTOR TOOLS®

## CMT XTREME BALANCING



### CMT XTREME BALANCING™

This system allows for extremely accurate dynamic balancing of the blade, several orders of magnitude above and beyond that which is currently available in the marketplace.

™TRADEMARK & INT. PAT. PEND.

## FLATNESS OF BODIES & BALANCING

Blade body flatness, obtained via straightening processes, guarantee exceptionally reduced tolerances. Balancing performed on all saw blades guarantees maximum stability.

## TENSIONING RING

A visible tension ring on the blade body provides stability during cut and perfect concentricity during rotation.



## LASER-CUT PREMIUM-QUALITY STEEL PLATE

Made of 46-48 HRC precision German steel which is laser-cut to provide tighter tolerances ensuring longer life and more accurate cuts.



MADE IN ITALY  
285.640.10  
Ø10"x0.126"/0.087"x5/8"  
Z-40 HI-ATB



## LASER-CUT HEAT EXPANSION SLOTS

Engineered to allow blade expansion from the stress of centrifugal force and heat build-up during heavy use, preventing blade warping.



## FILLED SLOTS

### LASER-CUT SLOTS FILLED WITH SOUND-DAMPENING MATERIAL

Slots filled with polyurethane reduce vibrations and noise (25% less than standard saw blades) improving cut quality and extending blade life. Located close to the toothed crown, these slots act as shock absorbers isolating the teeth from vibration. In full compliance with National Noise Emission Standards and Regulations.



## INDUSTRIAL CHROME CARBIDE

Cutting teeth are made from a specially formulated chrome carbide which stays sharper longer by reducing cutting edge abrasion, improving cut quality and tool life.

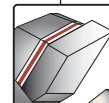

## TRI-METAL BRAZING

The Silver-Copper-Silver tri-metal brazing process lets the teeth withstand the severe impact caused by cutting harder woods and composite material.

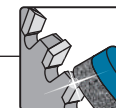

## PRECISION MIRROR FINISH SHARPENING

Each tooth is precision ground on a multi-axis CNC machine creating perfect edge angles and guaranteeing extra-clean cuts and extended life. Featuring less than 0.25 µm R max in edge roughness.

# INDUSTRIAL ORANGE SHIELD®

CMT's Industrial **ORANGE SHIELD®** blade line is designed for professional woodworkers and finish carpenters who run their blades all day long demanding ultimate precision and extended life, while conquering the most challenging applications.



## NON-STICK ORANGE SHIELD® PTFE-COATED

- Prevents overheating
- Protects against corrosion and rust
- Reduces resin build-up
- Reduces blade drag
- Improves performance and cutting life



- ★ ★ ★ ★ ★ INDUSTRIAL CHROME®
- ★ ★ ★ ★ ★ INDUSTRIAL ORANGE SHIELD®
- ★ ★ ★ ★ ★ ITK XTREME
- ★ ★ ★ ★ ITK PLUS®
- ★ ★ CMT CONTRACTOR TOOLS®

## CMT XTREME BALANCING™



### CMT XTREME BALANCING™

This system allows for extremely accurate dynamic balancing of the blade, several orders of magnitude above and beyond that which is currently available in the marketplace.

™TRADEMARK & INT. PAT. PEND.



### LASER-CUT PREMIUM-QUALITY STEEL PLATE

Made of 46-48 HRC precision German steel which is laser-cut to provide tighter tolerances ensuring longer life and more accurate cuts.

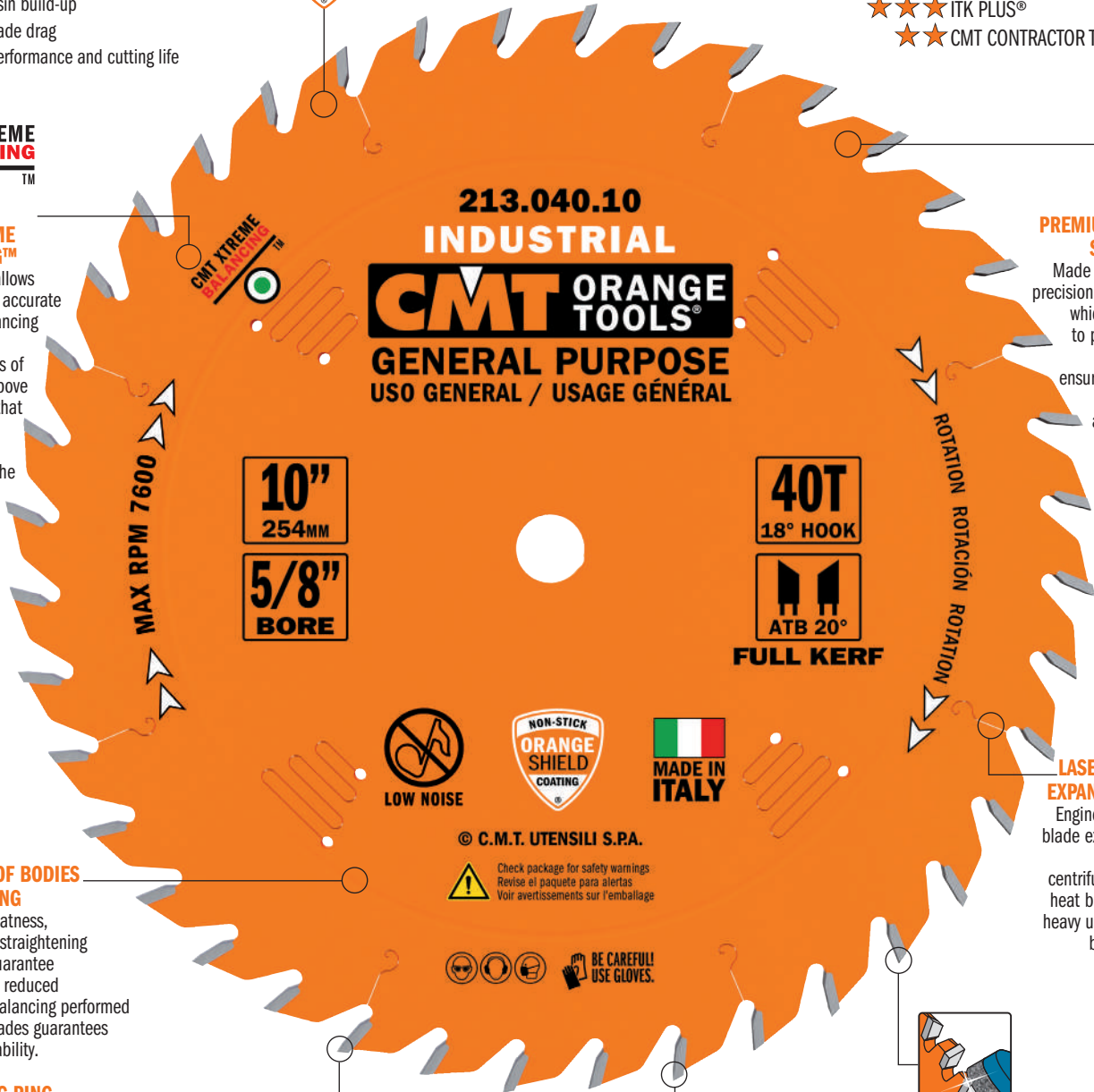

213.040.10

INDUSTRIAL

**CMT ORANGE TOOLS®**

GENERAL PURPOSE  
USO GENERAL / USAGE GÉNÉRAL

MAX RPM 7600

10"  
254MM

5/8"  
BORE

40T  
18° HOOK

ATB 20°

FULL KERF

ROTATION ROTACIÓN ROTATION



LOW NOISE



© C.M.T. UTENSILI S.P.A.

Check package for safety warnings  
Revisé el paquete para alertas  
Voir avertissements sur l'emballage



BE CAREFUL!  
USE GLOVES.

### LASER-CUT HEAT EXPANSION SLOTS

Engineered to allow blade expansion from the stress of centrifugal force and heat build-up during heavy use, preventing blade warping.

### FLATNESS OF BODIES & BALANCING

Blade body flatness, obtained via straightening processes, guarantee exceptionally reduced tolerances. Balancing performed on all saw blades guarantees maximum stability.

### TENSIONING RING

A visible tension ring on the blade body provides stability during cut and perfect concentricity during rotation.



### INDUSTRIAL CHROMIUM MICROGRAIN CARBIDE

Cutting teeth are made from a specially formulated chromium micrograin carbide which stays sharper longer by reducing cutting edge abrasion, improving cut quality and tool life.

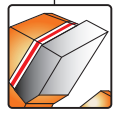

### TRI-METAL BRAZING

The Silver-Copper-Silver tri-metal brazing process lets the teeth withstand the severe impact caused by cutting harder woods and composite material.

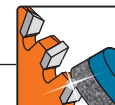

### PRECISION MIRROR FINISH SHARPENING

Each tooth is ground to razor sharp precision on a multi-axis CNC machine which creates perfect edge angles, guaranteeing extra-clean cuts and extended life. Featuring less than 0.25 µm R max in edge roughness.



# Ripping



**285 ORANGE CHROME®**  
**INDUSTRIAL**



**WOOD**

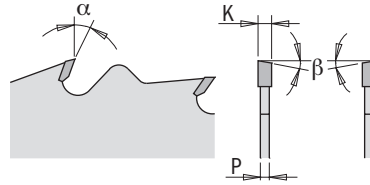

## MACHINES



Blade diameter compatibility is contingent on machine type.



## APPLICATIONS

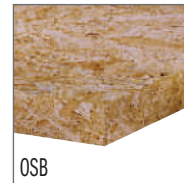

## MATERIALS



For specific details regarding suggested materials, please check blade label.

ORDER NO.		inches	D mm	T	B inches	PIN HOLE 	β	K inches	P inches	α
<b>285.624.10</b>	<b>5</b>	10	254	24	5/8		FLAT	0.126	0.087	15°
FOR MACHINES WITH METRIC ARBOR										
<b>285.624.10M</b>	<b>5</b>		250	24	30mm	COMBI3	FLAT	0.126	0.087	10°



## 201-293 ORANGE SHIELD® INDUSTRIAL

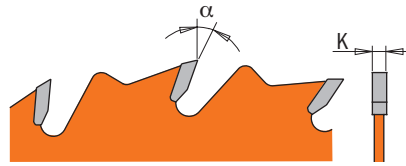

### MACHINES





Blade diameter compatibility is contingent on machine type.

### APPLICATIONS



### MATERIALS



ORDER NO.		inches	D mm	T	B inches	PIN HOLE 	$\beta$	K inches	P inches	$\alpha$
201.024.10	5	10	254	24	5/8		FTG	0.126	0.087	20°
201.030.12	5	12	305	30	1		FTG	0.126	0.087	20°
FOR MACHINES WITH METRIC ARBOR										
293.024.12M*	1		300	24	30mm	COMBI3	10° ATB	0.126	0.087	20°
293.028.14M*	1		350	28	30mm	COMBI3	10° ATB	0.137	0.098	20°

\* NOT ORANGE SHIELD®



# Multi-Rip with Rakers



## 279 ORANGE SHIELD® INDUSTRIAL

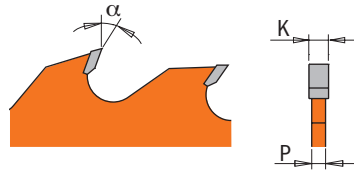

**WOOD**

### TECHNICAL DETAILS:

The rakers prevent contact between the steel plate and the material in use.

### MACHINES



Blade diameter compatibility is contingent on machine type.

### APPLICATIONS

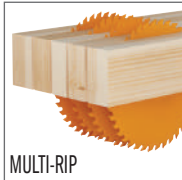

### MATERIALS



ORDER NO.		inches	D mm	T	B inches	$\beta$	K inches	P inches	$\alpha$
279.010.10	5	10	254	10+4	2-3/8	FLAT	0.157	0.098	25°
279.012.12	5	12	305	12+4	2-3/8	FLAT	0.157	0.098	25°

# Heavy-Duty Glue Line Ripping

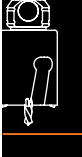
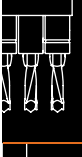

## 203 ORANGE CHROME® INDUSTRIAL

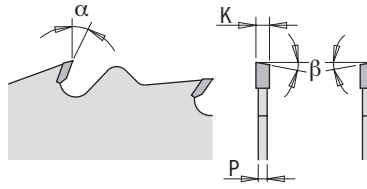

**WOOD**



### MACHINES



Blade diameter compatibility is contingent on machine type.

### APPLICATIONS



**SAND FREE**

### MATERIALS



ORDER NO.		D	T	B	KEY WAY	$\beta$	K	P	$\alpha$	
		inches	mm	inches			inches	inches		
203.630.10	1	10	254	30	5/8	TCG	0.126	0.087	12°	
203.636.12	1	12	305	36	1	TCG	0.126	0.087	12°	
203.036.12W2*	1	12	305	36	3-1/8	13.1 x 7.1 - 6.9 x 3.7mm	TCG	0.160	0.110	12°

\* NOT ORANGE CHROME®



# Heavy-Duty General Purpose



## 285 ORANGE CHROME® INDUSTRIAL



**WOOD**

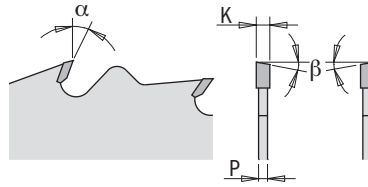

### MACHINES



Blade diameter compatibility is contingent on machine type.

### APPLICATIONS



### MATERIALS



For specific details regarding suggested materials, please check blade label.

ORDER NO.		D		T	B	PIN HOLE	$\beta$	K	P	$\alpha$
		inches	mm		inches			inches	inches	
285.640.10	1	10	254	40	5/8		30° Hi-ATB	0.126	0.087	12°
FOR MACHINES WITH METRIC ARBOR										
285.640.10M	1		250	40	30mm	COMBI3	10° ATB	0.126	0.087	15°
285.648.12M	1		300	48	30mm	COMBI3	10° ATB	0.126	0.087	5°
285.654.14M	1		350	54	30mm	COMBI3	10° ATB	0.137	0.098	5°
285.660.16M	1		400	60	30mm	COMBI3	15° ATB	0.137	0.098	10°



**213-290-291 ORANGE SHIELD® INDUSTRIAL**

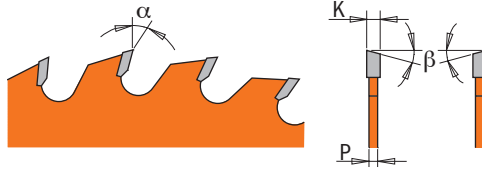

**WOOD**



**MACHINES**



Blade diameter compatibility is contingent on machine type.

**APPLICATIONS**

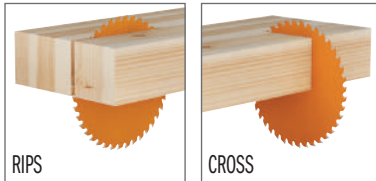

**MATERIALS**



For specific details regarding suggested materials, please check blade label.

**213**



ORDER NO.		D		T	B	$\beta$	K	P	$\alpha$
		inches	mm		inches		inches	inches	
213.040.10	5	10	254	40	5/8	20° ATB	0.126	0.100	18°
213.048.12	5	12	305	48	1	20° ATB	0.126	0.100	10°

**290-291 FOR MACHINES WITH METRIC ARBOR**



ORDER NO.		D		T	B	PIN HOLE	$\beta$	K	P	$\alpha$
		inches	mm		mm			inches	inches	
291.160.24H	10		160	24	20	2/6/32	15° ATB	0.087	0.062	15°
291.165.24H	10	6-1/2	165	24	20	2/6/32	15° ATB	0.087	0.062	15°
290.210.24M	10	8-1/4	210	24	30	2/7/42	10° ATB	0.110	0.071	20°
291.210.36M	10	8-1/4	210	36	30	2/7/42	15° ATB	0.110	0.071	15°

- Ideal for FESTOOL®
- Ideal for Track Saws



# Combination



**285.6** ORANGE CHROME®  
**INDUSTRIAL**



**WOOD**

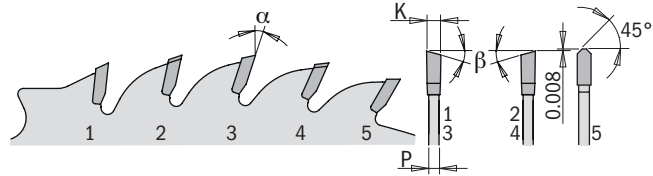

## MACHINES



Blade diameter compatibility is contingent on machine type.

## APPLICATIONS



## MATERIALS



ORDER NO.		D	T	B	$\beta$	K	P	$\alpha$	
		inches	mm	inches		inches	inches		
285.650.10	1	10	254	50	5/8	4 ATB 20°+1 TCG	0.126	0.087	12°



**215 ORANGE SHIELD® INDUSTRIAL**



**WOOD**

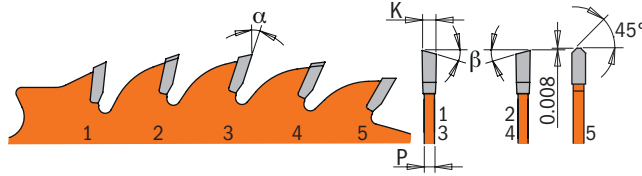

**MACHINES**



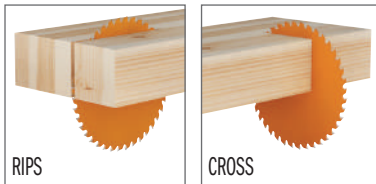

Blade diameter compatibility is contingent on machine type.

**APPLICATIONS**

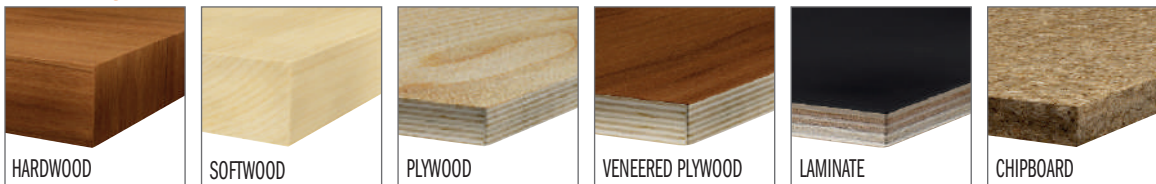

**MATERIALS**



ORDER NO.		D inches	D mm	T	B inches		$\beta$	K inches	P inches	$\alpha$
215.050.10	5	10	254	50	5/8		4 ATB 20° + 1 TCG	0.126	0.087	12°
215.060.12	5	12	305	60	1		4 ATB 20° + 1 TCG	0.126	0.087	12°



**285 ORANGE CHROME® INDUSTRIAL**



**WOOD**

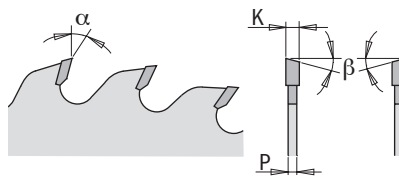

**MACHINES**



Blade diameter compatibility is contingent on machine type.

**APPLICATIONS**



**MATERIALS**



For specific details regarding suggested materials, please check blade label.

ORDER NO.		inches	D mm	T	B inches	PIN HOLE	$\beta$	K inches	P inches	$\alpha$
285.660.10	1	10	254	60	5/8		20° ATB	0.126	0.087	10°
285.672.12	1	12	305	72	1		20° ATB	0.126	0.087	10°
285.684.14	1	14	355	84	1		15° ATB	0.137	0.098	10°
285.696.16*	1	16	406	96	1		15° ATB	0.137	0.098	10°
285.708.18*	1	18	457	108	1		15° ATB	0.150	0.110	10°
FOR MACHINES WITH METRIC ARBOR										
285.760.48H ●	5		160	48	20mm	2/6/32	12° ATB	0.086	0.063	5°
285.790.48FF ●	5		190	48	20mm (FESTOOL® FF)		15° ATB	0.094	0.071	8°
285.816.60M	5		216	60	30mm	2/7/42	15° ATB	0.090	0.063	-5° Neg.
285.660.10M	5		250	60	30mm	COMBI3	15° ATB	0.126	0.087	10°
285.672.12M	5		300	72	30mm	COMBI3	15° ATB	0.126	0.087	10°

● Ideal for FESTOOL®  
\* NOT ORANGE CHROME®





**205-292-294 ORANGE SHIELD® INDUSTRIAL**

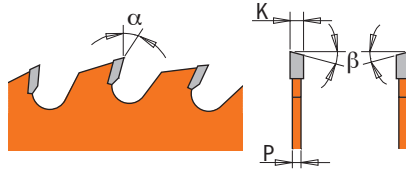

**WOOD**



**MACHINES**



Blade diameter compatibility is contingent on machine type.

**APPLICATIONS**



**MATERIALS**



For specific details regarding suggested materials, please check blade label.

**205**



ORDER NO.		D inches	D mm	T	B inches	$\beta$	K inches	P inches	$\alpha$
205.060.10	5	10	254	60	5/8	20° ATB	0.102	0.071	5°
205.072.12	5	12	305	72	1	15° ATB	0.126	0.087	10°

**292-294 FOR MACHINES WITH METRIC ARBOR**



ORDER NO.		D inches	D mm	T	B mm	PIN HOLE	$\beta$	K inches	P inches	$\alpha$
292.160.40H	10		160	40	20	2/6/32	15° ATB	0.087	0.062	10°
292.165.40H	10	6-1/2	165	40	20	2/6/32	15° ATB	0.087	0.062	10°
292.210.48M	10	8-1/4	210	48	30	2/7/42	15° ATB	0.110	0.071	15°
294.060.11M	10		260	60	30	COMBI3	15° ATB	0.098	0.071	-5° Neg.

- Ideal for FESTOOL®
- Ideal for Track Saws

# Heavy-Duty Fine Finish



## 281.6 ORANGE CHROME® INDUSTRIAL



**WOOD**

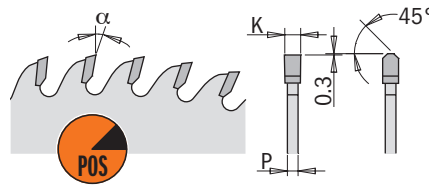

### MACHINES

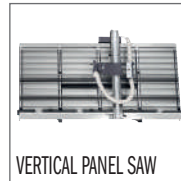

Blade diameter compatibility is contingent on machine type.

### APPLICATIONS

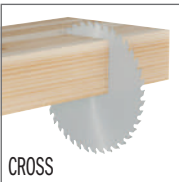

### MATERIALS

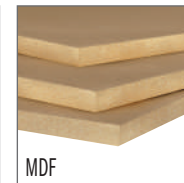

For specific details regarding suggested materials, please check blade label.

ORDER NO.		D	T	B	PIN HOLE	$\beta$	K	P	$\alpha$	
		inches	mm	inches			inches	inches		
281.660.10	5	10	254	60	5/8	TCG	0.126	0.087	10°	
FOR MACHINES WITH METRIC ARBOR										
281.760.48H ●	5		160	48	20mm	TCG	0.126	0.087	4°	
281.672.12M	5		300	72	30mm	COMBI3	0.126	0.087	10°	
281.684.14M	3		350	84	30mm	COMBI3	0.137	0.098	10°	

● Ideal for FESTOOL®



**221 ORANGE SHIELD® INDUSTRIAL**

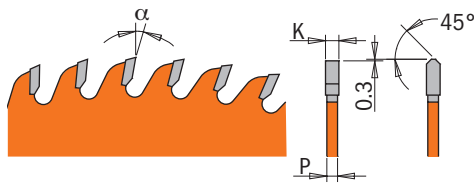

**WOOD**



**MACHINES**

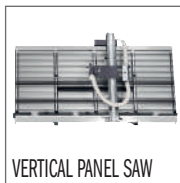

Blade diameter compatibility is contingent on machine type.

**APPLICATIONS**

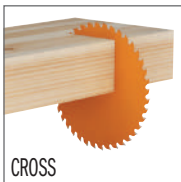

**MATERIALS**



ORDER NO.		D inches	D mm	T	B inches	$\beta$	K inches	P inches	$\alpha$
221.060.10	5	10	254	60	5/8	TCG	0.126	0.087	10°
221.072.12	5	12	305	72	1	TCG	0.126	0.087	10°



# Fine Finish Sliding Compound



## 285.6 ORANGE CHROME® INDUSTRIAL

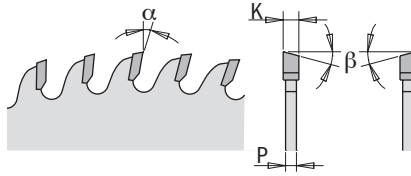

### MACHINES



Blade diameter compatibility is contingent on machine type.

### APPLICATIONS



### MATERIALS

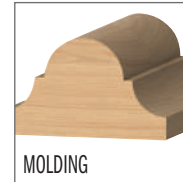

ORDER NO.		inches	D mm	T	B inches	$\beta$	K inches	P inches	$\alpha$
285.680.12	1	12	305	80	1	15° ATB	0.094	0.071	5°

# Ultra Finish Sliding Compound



## 274 ORANGE CHROME® INDUSTRIAL



**WOOD**

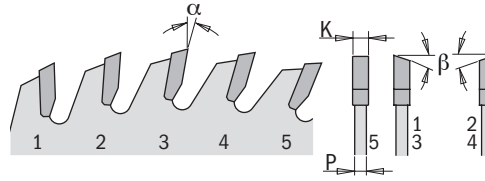

### MACHINES



Blade diameter compatibility is contingent on machine type.

### APPLICATIONS



### MATERIALS

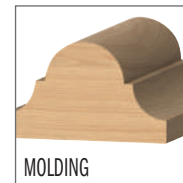

ORDER NO.		inches	D	mm	T	B	inches	$\beta$	K	inches	P	inches	$\alpha$
274.691.12	1	12		305	90	5/8		4 ATB 20°+ 1 FLAT	0.118		0.098		-3° Neg.



**285 ORANGE CHROME®  
INDUSTRIAL**

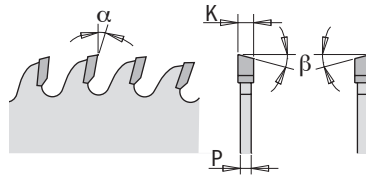

**MACHINES**



Blade diameter compatibility is contingent on machine type.

**APPLICATIONS**

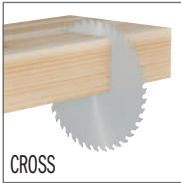

**MATERIALS**

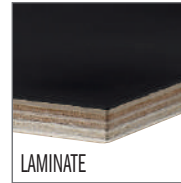

For specific details regarding suggested materials, please check blade label.

ORDER NO.		D		T	B		β	K	P	α
		inches	mm							
285.680.10	1	10	254	80	5/8		20° ATB	0.118	0.098	10°
285.696.12	1	12	305	96	1		20° ATB	0.118	0.098	10°





## 219 ORANGE SHIELD® INDUSTRIAL



**WOOD**

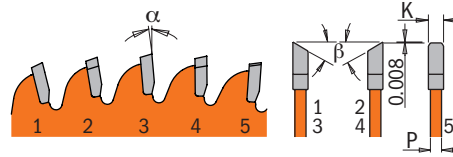

### MACHINES



Blade diameter compatibility is contingent on machine type.

### APPLICATIONS



### MATERIALS

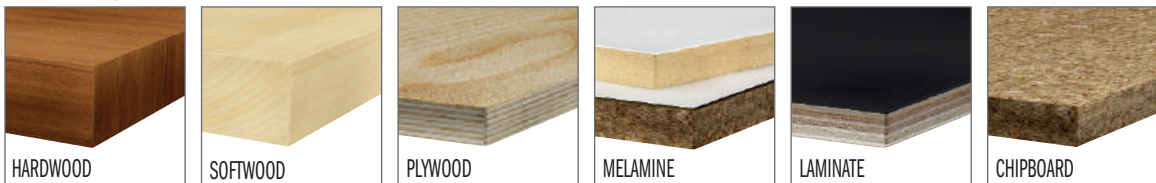

ORDER NO.		D	T	B	β	K	P	α
		inches	mm	inches		inches	inches	
219.060.08	5	8-1/2	216	60	5/8	4 Hi-ATB 30°+ 1 TCG	0.118	0.100 -5° Neg.
219.080.10	5	10	254	80	5/8	4 Hi-ATB 30°+ 1 TCG	0.122	0.100 -5° Neg.
219.090.12	5	12	305	90	1	4 Hi-ATB 30°+ 1 TCG	0.122	0.100 -5° Neg.



## 283.6 ORANGE CHROME® INDUSTRIAL



**WOOD**

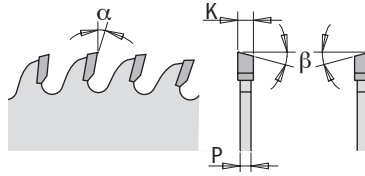

### MACHINES



Blade diameter compatibility is contingent on machine type.

### APPLICATIONS



### MATERIALS

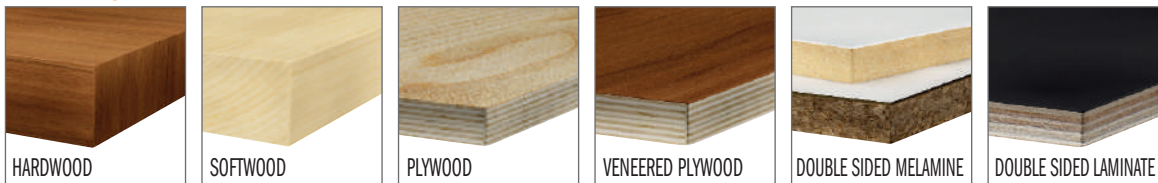

For specific details regarding suggested materials, please check blade label.

ORDER NO.		inches	D	mm	T	B	PIN HOLE	$\beta$	K	P	$\alpha$
283.680.10	1	10	254	80	5/8			38° Hi-ATB	0.126	0.087	2°
283.696.12	1	12	305	96	1			38° Hi-ATB	0.126	0.087	2°
FOR MACHINES WITH METRIC ARBOR											
283.064.09M*		1		220	64	30mm	2/7/42	40° Hi-ATB	0.126	0.087	-5° Neg.
283.680.10M	5			250	80	30mm	COMBI3	38° Hi-ATB	0.126	0.087	-2° Neg.
283.696.12M	5			300	96	30mm	COMBI3	38° Hi-ATB	0.126	0.087	2°
283.108.14M*		1		350	108	30mm	COMBI3	40° Hi-ATB	0.137	0.098	5°

\* NOT ORANGE CHROME®



**210-292-294 ORANGE SHIELD<sup>®</sup> INDUSTRIAL**

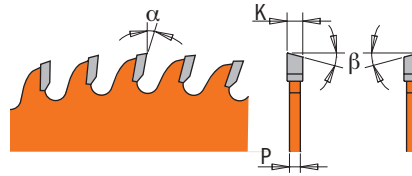

**WOOD**



**MACHINES** Blade diameter compatibility is contingent on machine type.



**APPLICATIONS**

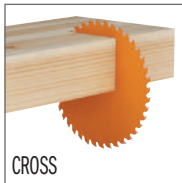

**MATERIALS** For specific details regarding suggested materials, please check blade label.



**210**



ORDER NO.		D inches	D mm	T	B inches	$\beta$	K inches	P inches	$\alpha$
210.060.08	5	8-8-1/4	203	60	5/8	38° Hi-ATB	0.126	0.087	2°
210.080.10	5	10	254	80	5/8	38° Hi-ATB	0.126	0.087	2°
210.096.12	5	12	305	96	1	38° Hi-ATB	0.126	0.087	2°

**292-294 FOR MACHINES WITH METRIC ARBOR**



ORDER NO.		D inches	D mm	T	B mm	PIN HOLE	$\beta$	K inches	P inches	$\alpha$
292.160.56H	10		160	56	20	2/6/32	15° ATB	0.087	0.063	15°
292.165.56H	10	6-1/2	165	56	20	2/6/32	15° ATB	0.087	0.063	15°
292.210.64M	10		210	64	30	2/7/42	15° ATB	0.110	0.071	15°
292.216.80M	10		216	80	30	2/7/42	15° ATB	0.110	0.071	-5° Neg.
292.230.64M	10		230	64	30	2/7/42-2/6/10	15° ATB	0.110	0.071	15°
294.080.11M	5		260	80	30	COMBI3	15° ATB	0.098	0.071	-5° Neg.

Ideal for FESTOOL<sup>®</sup>  
 Ideal for Track Saws



# Single-Sided - Laminate & Melamine



## 281.6 ORANGE CHROME® INDUSTRIAL



**WOOD**

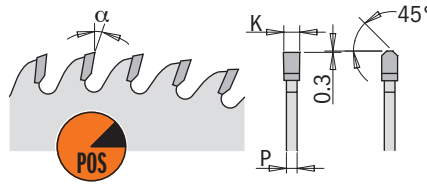

### MACHINES



Blade diameter compatibility is contingent on machine type.

### APPLICATIONS



### MATERIALS

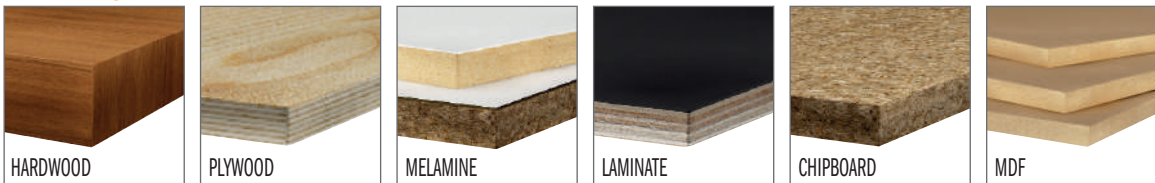

ORDER NO.		inches	D mm	T	B inches	PIN HOLE	$\beta$	K inches	P inches	$\alpha$
281.680.10	1	10	254	80	5/8		TCG	0.126	0.087	5°
281.696.12	1	12	305	96	1		TCG	0.126	0.087	5°
FOR MACHINES WITH METRIC ARBOR										
281.680.10M	5		250	80	30mm	COMBI3	TCG	0.126	0.087	10°
281.696.12M	5		300	96	30mm	COMBI3	TCG	0.126	0.087	10°
281.708.14M	3		350	108	30mm	COMBI3	TCG	0.138	0.098	5°

# Double-Sided - Laminate & Melamine



## 281.6 ORANGE CHROME® INDUSTRIAL



**WOOD**

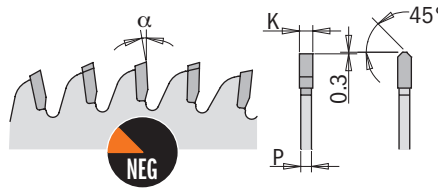

### MACHINES



Blade diameter compatibility is contingent on machine type.

### APPLICATIONS



### MATERIALS



For specific details regarding suggested materials, please check blade label.

ORDER NO.		inches	D mm	T	B inches	PIN HOLE	$\beta$	K inches	P inches	$\alpha$
281.681.10	1	10	254	80	5/8		TCG	0.126	0.087	-3° Neg.
281.697.12	1	12	305	96	1		TCG	0.126	0.087	-3° Neg.
FOR MACHINES WITH METRIC ARBOR										
281.681.10M	5		250	80	30mm	COMBI3	TCG	0.126	0.087	-3° Neg.
281.697.12M	5		300	96	30mm	COMBI3	TCG	0.126	0.087	-3° Neg.

**XTREME INDUSTRIAL**

**CARBIDE TIPPED LONG LIFE**

★ ★ ★ ★ ★  
**PERFORMANCE**

**WOOD**



**288**

**289**

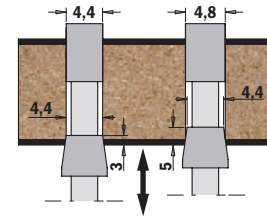

**TIPS 288:** suggested for machines with vertical regulation of scoring blade.

Suggested for use with thick kerf or panel sizing blade.

**MACHINES**



**APPLICATIONS**

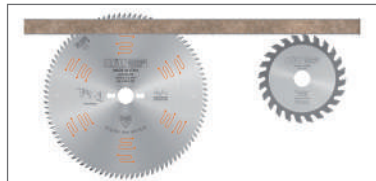

**MATERIALS**

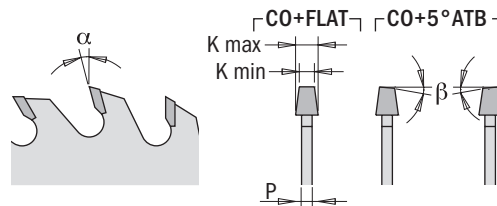

**288 Conical**

ORDER NO.		D mm	T	B mm	PIN HOLE	β	K mm	P mm	α
288.100.20H	10	100	20	20		CO + 5° ATB	3.1-4.0	2.5	5°
288.100.20K	10	100	20	22		CO + 5° ATB	3.1-4.0	2.5	5°
288.120.24H	10	120	24	20		CO + 5° ATB	3.1-4.0	2.5	5°
288.120.24K	10	120	24	22		CO + 5° ATB	3.1-4.0	2.5	5°
288.125.24H	10	125	24	20		CO + 5° ATB	3.1-4.0	2.5	5°
288.125.24K	10	125	24	22		CO + 5° ATB	3.1-4.0	2.5	5°
288.125.24Q	10	125	24	45		CO + FLAT	4.3-5.5	3.2	10°
288.160.36Q	5	160	36	45	3/11/70	CO + FLAT	4.3-5.5	3.2	10°
288.160.360	5	160	36	55	3/7/66	CO + FLAT	4.3-5.5	3.2	10°
288.180.36Q	5	180	36	45		CO + FLAT	4.7-6.0	3.5	10°
288.180.360	5	180	36	55		CO + FLAT	5.0-6.2	3.5	10°
288.200.36Q	5	200	36	45		CO + FLAT	4.7-6.0	3.5	10°
288.200.36J	5	200	36	65	2/9/110	CO + FLAT	4.3-5.5	3.2	10°

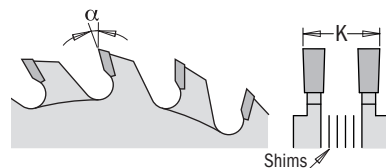

**TIPS:** suggested for machines without vertical regulation of scoring blade.

**289 Adjustable**

ORDER NO.		D mm	T	B mm	β	K mm	α
289.100.20H	10	100	10+10	20	FLAT	2.8-3.6	12°
289.120.24H	10	120	12+12	20	FLAT	2.8-3.6	12°
289.120.24K	10	120	12+12	22	FLAT	2.8-3.6	12°

**Spare parts**

PVC SHIMS

299.000.02K

299.000.02K

299.000.02K





## 281-282 INDUSTRIAL



**WOOD**

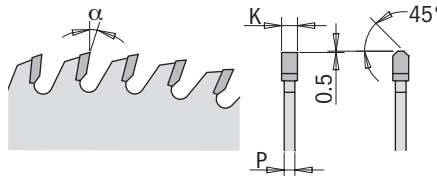

### MACHINES

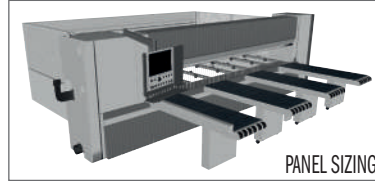

ORDER NO.		D mm	T	B mm	PIN HOLE	$\beta$	K mm	P mm	$\alpha$
281.064.09M	1	220	64	30	2/7/42	TCG	3.2	2.2	10°
281.680.10M	5	250	80	30	2/10/60+2/7/42	TCG	3.2	2.2	5°
282.060.12M	1	300	60	30	2/10/60	TCG	4.4	3.2	16°
282.060.12X	1	300	60	75		TCG	4.4	3.2	16°
282.060.12W	1	300	60	80	COMBI5	TCG	4.4	3.2	16°
281.672.12M	5	300	72	30	2/10/60+2/7/42	TCG	3.2	2.2	10°
281.696.12M	1	300	96	30	2/10/60+2/7/42	TCG	3.2	2.2	5°
282.072.13J	1	320	72	65	2/9/100 + 2/9/110	TCG	4.4	3.2	16°
282.072.14M	1	350	72	30	4/9/100	TCG	4.4	3.2	16°
282.072.14T	1	350	72	50	3/12.5/80	TCG	4.4	3.2	16°
Y282.072.14U	1	350	72	60	2/14/100	TCG	4.4	3.2	16°
282.072.14X	1	350	72	75	4/15/105+3/7/100	TCG	4.4	3.2	16°
282.072.14W	1	350	72	80	COMBI5	TCG	4.4	3.2	16°
281.708.14M	1	350	108	30	COMBI3	TCG	3.5	2.5	5°
282.072.14J2	1	355	72	65	COMBI5	TCG	4.4	3.2	16°
282.072.14W2	1	355	72	80	COMBI5	TCG	4.4	3.2	16°
282.072.15U2	1	380	72	60	COMBI5	TCG	4.4	3.2	15°
282.072.15U	1	380	72	60	COMBI7	TCG	4.8	3.5	16°
282.072.15W	1	380	72	80	COMBI5	TCG	4.4	3.2	16°
282.072.16M	1	400	72	30	2/10/60	TCG	4.4	3.2	16°
282.072.16U	1	400	72	60	COMBI7	TCG	4.4	3.2	16°
282.072.16X	1	400	72	75	4/15/105	TCG	4.4	3.2	16°
282.072.16W	1	400	72	80	COMBI5	TCG	4.4	3.2	16°
282.072.17W	1	420	72	80	COMBI5	TCG	4.4	3.2	15°
282.072.17X	1	430	72	75	4/15/105	TCG	4.4	3.2	16°
282.072.17W2	1	430	72	80	COMBI5	TCG	4.4	3.2	16°
282.072.18U	1	450	72	60	COMBI7	TCG	4.8	3.5	16°
282.072.18W2	1	450	72	80	COMBI5	TCG	4.8	3.5	16°
282.072.20U	1	500	72	60	COMBI7	TCG	4.8	3.5	16°

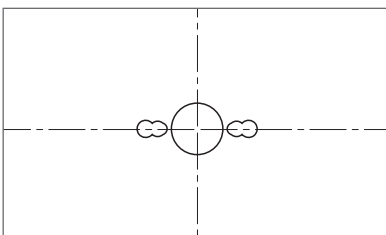

2/7/42mm  
**COMBI3 PIN HOLE:**  
 2/9.5/46.5mm    2/10/60mm

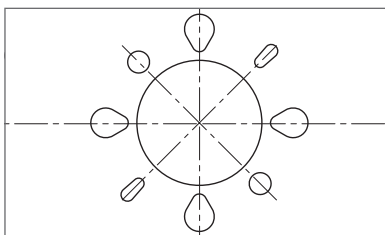

2/7/110mm  
**COMBI5 PIN HOLE:**  
 2/8.4/130mm    2/14/110mm    4/9/100mm    4/19/120mm

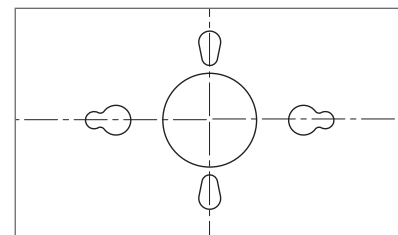

2/10/80mm  
**COMBI7 PIN HOLE:**  
 1/11/85mm    2/11/115mm  
 2/14/100mm    2/14/125mm

# THIN Non-Ferrous Metal (<1/8") & Plastics



## 284 ORANGE SHIELD® INDUSTRIAL

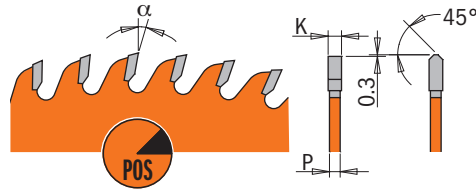

### MACHINES

\*WITH MEC/MAN WORKPIECE CLAMPING

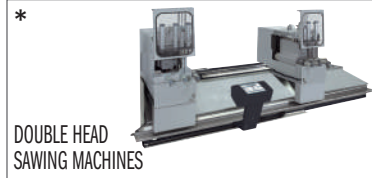

Blade diameter compatibility is contingent on machine type.

### MATERIALS

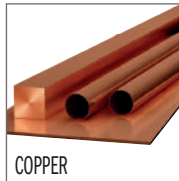
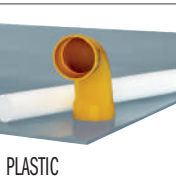

For specific details regarding suggested materials, please check blade label.

ORDER NO.		D		T	B	$\beta$	K	P	$\alpha$
		inches	mm		inches		inches	inches	
284.700.10	5	10	254	96	5/8	TCG	0.126	0.098	6°
284.720.12	5	12	305	108	1	TCG	0.126	0.098	6°

# THICK Non-Ferrous Metal (>1/8") & Melamine



## 225-296-297 ORANGE SHIELD® INDUSTRIAL

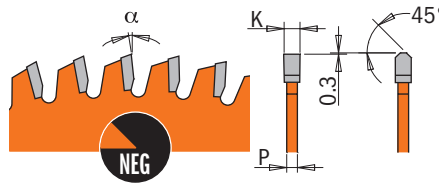

NON-FERROUS



### MACHINES



Blade diameter compatibility is contingent on machine type.

### MATERIALS

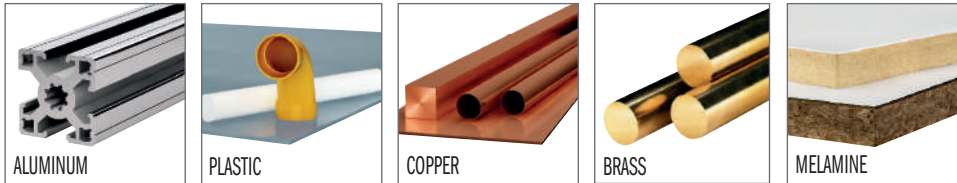

## 225



ORDER NO.		D inches	D mm	T	B inches	$\beta$	K inches	P inches	$\alpha$
225.060.08	5	8-1/2	216	60	5/8	TCG	0.122	0.098	-7° Neg.
225.672.10	5	10	254	80	5/8	TCG	0.126	0.098	-6° Neg.
225.696.12	5	12	305	96	1	TCG	0.126	0.098	-6° Neg.
225.709.12	5	12	305	108	5/8	TCG	0.126	0.098	-6° Neg.
225.700.14*	5	14	355	100	1	TCG	0.126	0.098	-6° Neg.
225.720.14*	5	14	355	120	1	TCG	0.142	0.119	-6° Neg.
225.700.16*	5	16	406	100	1	TCG	0.150	0.126	-6° Neg.
225.708.18*	5	18	457	108	1	TCG	0.150	0.126	-6° Neg.
225.728.18*	5	18	457	128	1	TCG	0.150	0.126	-6° Neg.

## 296-297 FOR MACHINES WITH METRIC ARBOR



ORDER NO.		D inches	D mm	T	B mm	PIN HOLE	$\beta$	K inches	P inches	$\alpha$
296.160.56H	10		160	56	20	2/6/32	TCG	0.087	0.062	-6° Neg.
296.165.56H	10	6-1/2	165	56	20	2/6/32	TCG	0.087	0.062	-6° Neg.
296.210.64M	10	8-1/4	210	64	30	2/7/42	TCG	0.110	0.087	-6° Neg.
297.080.11M*	5		260	80	30	COMBI3	TCG	0.126	0.098	-6° Neg.

● Ideal for FESTOOL® \* NOT ORANGE SHIELD®  
 ■ Ideal for Track Saws

■ Until stock last



# THIN - Metal & Steel (Less than 3/32")



## 226 ORANGE SHIELD® INDUSTRIAL

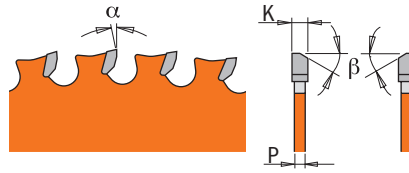

**METAL & STEEL**

### MACHINES



Blade diameter compatibility is contingent on machine type.

### MATERIALS

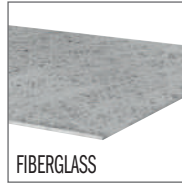
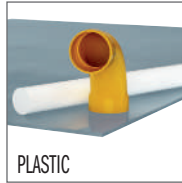

ORDER NO.		inches	D mm	T	B inches	$\beta$	K inches	P inches	$\alpha$	MAX RPM
226.165.60H	5	6-1/2	165	60	20mm	8° FWF	0.063	0.047	0°	6000
226.060.10	5	10	254	60	5/8	8° FWF	0.087	0.071	0°	3000
226.080.12	5	12	305	80	1	8° FWF	0.087	0.071	0°	2000
226.090.14	5	14	355	90	1	8° FWF	0.087	0.071	0°	2000

■ Ideal for Track Saws

# MEDIUM/THICK - Metal & Steel (1/16"~1/2")



## 226 ORANGE SHIELD® INDUSTRIAL

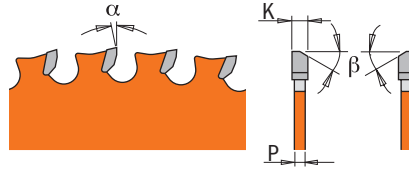

**METAL & STEEL**

### MACHINES



Blade diameter compatibility is contingent on machine type.

### MATERIALS



ORDER NO.		D	T	B	PIN HOLE	β	K	P	α	MAX RPM
		inches	mm	inches			inches	inches		
226.030.05	10	5-3/8	136	30	10mm	8° FWF	0.059	0.047	0°	6000
226.030.05H	10	5-3/8	136	30	20mm	8° FWF	0.059	0.047	0°	6000
226.030.06H	10		160	30	20mm	2/6/32	8° FWF	0.079	0.063	6000
226.036.06	10	6-1/2	165	36	5/8	8° FWF	0.059	0.047	0°	6000
226.036.06H	10	6-1/2	165	36	20mm	8° FWF	0.059	0.047	0°	6000
226.048.07	10	7-1/4	184	48	5/8	8° FWF	0.079	0.063	0°	6000
226.048.08	10	8-8-1/4	203	48	5/8	8° FWF	0.087	0.071	0°	4500
226.048.08M	10	8-1/4	210	48	30mm	2/7/42	8° FWF	0.087	0.071	4500
226.048.10	5	10	254	48	5/8	8° FWF	0.087	0.071	0°	3000
226.060.12	5	12	305	60	1	8° FWF	0.087	0.071	0°	2000
226.072.14	5	14	355	72	1	8° FWF	0.087	0.071	0°	2000

- Ideal for FESTOOL®
- Ideal for Track Saws



## 226 ORANGE SHIELD® INDUSTRIAL

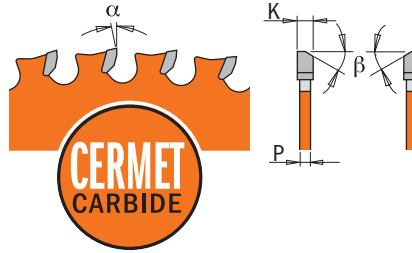

**METAL & STEEL**

### MACHINES



Blade diameter compatibility is contingent on machine type.

### MATERIALS



Suggested for Stainless steel of common use, such as 302, 303 and 304. With higher degrees of hardness, performance is not guaranteed (e.g. 316)

ORDER NO.		D		T	B	β	K	P	α	MAX RPM
		inches	mm		inches		inches	inches		
226.548.07	10	7-1/4	184	48	5/8	8° FWF	0.079	0.063	0°	6000
226.572.10	5	10	254	72	5/8	8° FWF	0.087	0.071	0°	3000
226.580.12	5	12	305	80	1	8° FWF	0.087	0.071	0°	2000
226.590.14	5	14	355	90	1	8° FWF	0.087	0.071	0°	2000



# Heavy-Duty Solid Surface & Composite Decking



## 223 ORANGE SHIELD® INDUSTRIAL



**MULTI-MATERIALS**

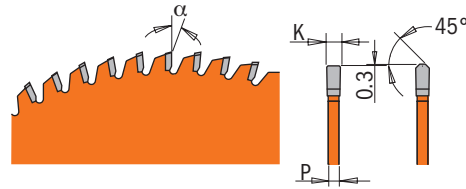

### MACHINES

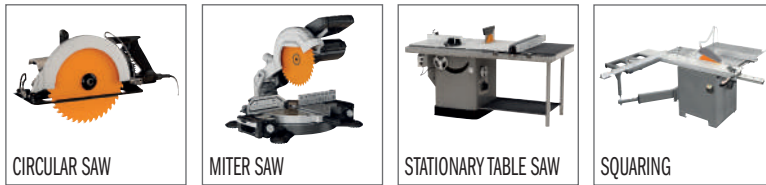

Blade diameter compatibility is contingent on machine type.

### MATERIALS



ORDER NO.		inches	D mm	T	B inches	PIN HOLE 	$\beta$	K inches	P inches	$\alpha$
223.048.06H* ●	5		160	48	20mm	2/6/32	MTCG	0.087	0.063	0°
223.672.10	5	10	254	72	5/8		MTCG	0.126	0.098	0°
223.684.12	5	12	305	84	1		MTCG	0.126	0.098	0°

● Ideal for FESTOOL®  
\* NOT ORANGE SHIELD®



**222 INDUSTRIAL**



**MULTI-MATERIALS**

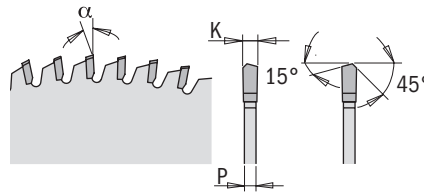

**MACHINES**



**MATERIALS**

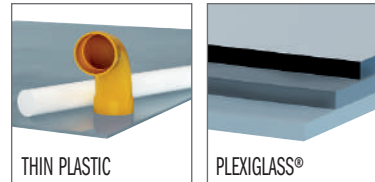

Blade diameter compatibility is contingent on machine type.

ORDER NO.		D inches	mm	T	B inches	$\beta$	K inches	P inches	$\alpha$
222.080.10	5	10	254	80	5/8	MATB	0.110	0.087	-3° Neg.
222.096.12	5	12	305	96	1	MATB	0.110	0.087	-3° Neg.

**Box & Finger Joint Set**



**230.224**



Yet another practical solution for making box and finger joints easily and quickly. This set contains two identical blades featuring 24 teeth and 5/8" bore. This not only offers the distinctive advantage of producing 1/4" grooves with the use of one single blade but also extends the groove to 3/8" thickness by laying the two blades upon each other, with no setting and shims needed.

**The set highlights:**

- Excellent and precise cuts on soft and hardwood for fine joinery
- Only one cutter, instead of two, is required for producing 1/4" thick grooves, no longer two
- 3 shims for adjustment after re-sharpening
- You will need to lay two cutters upon each other for making 3/8" grooves

**THE SET INCLUDES:**

- 2 blades kerf 1/4"
- 2 shims 0.004
- 1 shim 0.012

Sturdy reusable carrying case

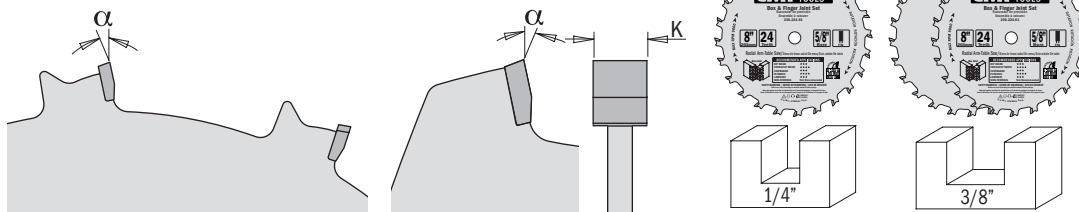

U.S. Patent No. Des. D621155

ORDER NO.		D inches	mm	T	B inches	SHIMS	$\beta$	K inches	P inches	$\alpha$
230.224.08	3	8	203	24+24	5/8	2 x 0.004 + 1x0.012	FTG	0.250	0.125	15°

Spare parts: 230.224.01 8" blade kerf 1/4"  
299.001.00 Shim 0.004  
299.003.00 Shim 0.012

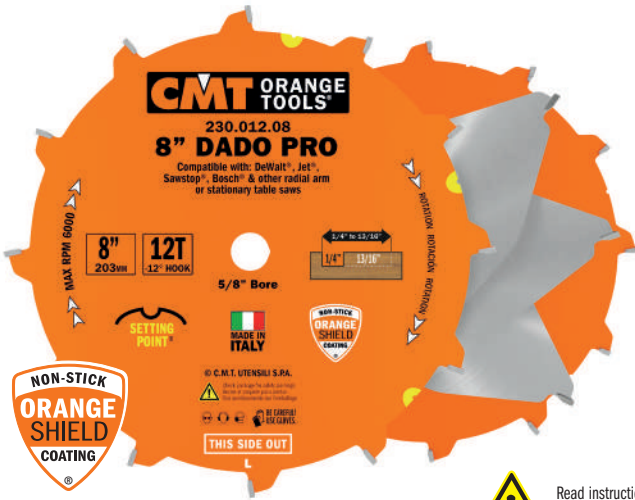

**230.012**

CMT designed a new Dado Pro Set with the following features:

- Ideal for tongue & groove, shelving and rabbets in solid wood, laminates & melamines, veneer plywood.
- Orange Shield Coating protect from heat, gumming and corrosion.
- New Setting Points for chippers alignment.
- Includes shims and spacers set for micro-thinadjustability.
- Ideal for underpowered saws.



**WOOD**

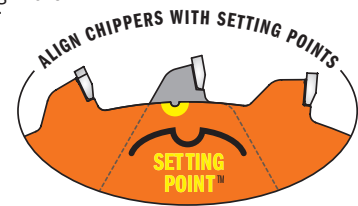

Read instructions sheet before use (you can also download it from our website). Always use both outside blades. Never use the chippers by themselves, or with only one outside blade. Securely fasten CMT Dado on machine using manufacturer's recommended dado arbor nut.

**MACHINES**

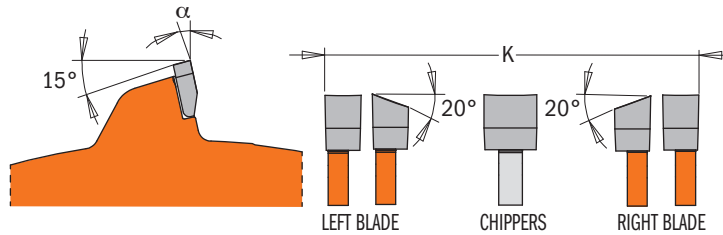

Sturdy reusable carrying case



**SET INCLUDES:**

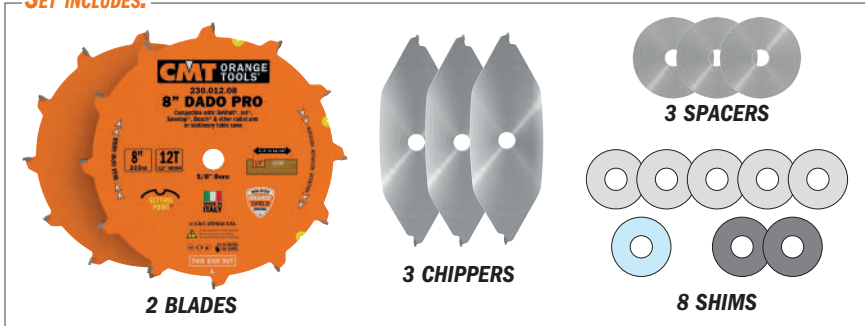

For flat bottom grooves & virtually splinter-free cuts

Nominal Widths	1/4"	5/16"	11/32"	3/8"	13/32"	7/16"	15/32"	1/2"	17/32"	9/16"	19/32"	5/8"	21/32"	11/16"	23/32"	3/4"	25/32"	13/16"
	Left Blade	●	●	●	●	●	●	●	●	●	●	●	●	●	●	●	●	●
Right Blade	●	●	●	●	●	●	●	●	●	●	●	●	●	●	●	●	●	●
Chipper 1/8"	0	0	0	1	1	1	1	2	2	2	2	3	3	3	3	3	3	3
Spacer 1/16"	0	1	1	0	0	1	1	0	0	1	1	0	0	1	1	2	2	3
Shim 0.004"	1	1	1	0	0	0	0	0	0	0	0	0	0	0	0	0	0	0
Shim 0.008"	0	0	0	1	1	1	1	1	1	1	1	1	1	1	1	1	1	1
Shim 0.012"	0	0	1	0	1	0	1	0	1	0	1	0	1	0	1	0	1	0
Shim 0.020"	0	0	1	0	1	0	1	0	1	0	1	0	1	0	1	0	1	0



ORDER NO.	3	D inches	mm	T	B inches	CHIPPERS	β	K inches	SPACER	α
230.012.08	3	8	203	12	5/8	3 x 1/8"	FLAT+ATB	1/4 to 13/16	3 x 1/16"	-12° Neg.

Spare parts: 299.000.09 Dado Pro Shim Set



# Precision Dado



## 230.5

CMT designed a new Dado Precision Set with the following features:

- New Setting Points for chippers alignment.
- For flat bottom grooves & virtually splinter-free cuts in solid wood, laminates & melamines, veneer plywood.
- Includes shims (plastic & magnetic) and plastic "lock spacers" set for micro-thin adjustability.
- Orange Shield Coating protect from heat, gumming and corrosion.



**WOOD**

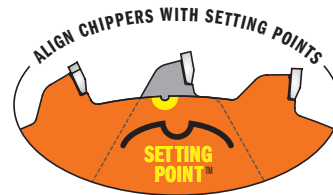

Always use both outside blades.  
Never use the chippers by themselves, or with only one outside blade. Securely fasten CMT Dado on machine using manufacturer's recommended dado arbor nut.

### MATERIALS



### MACHINES



### 230.524.08 SET INCLUDES:

- A - Left Outside Blade (qty: 1)
- B - Right Outside Blade (qty: 1)
- C - Chippers 1/8" (qty: 3)
- D - Spacers 1/16" (qty: 3)
- E - Shims 0.004" (qty: 5)
- F - Shim 0.008" (qty: 1)
- G - Magnetic Shim 0.012" (qty: 1)
- H - Magnetic Shim 0.020" (qty: 1)



SPARE PART SET: 299.000.09

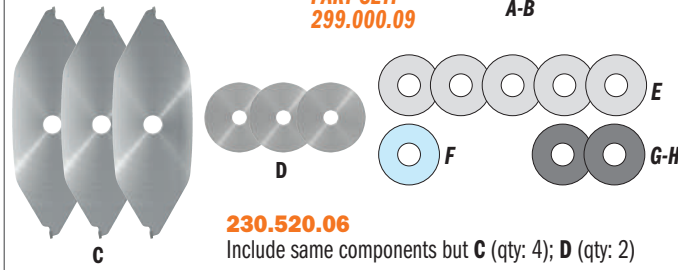

230.520.06 Include same components but C (qty: 4); D (qty: 2)

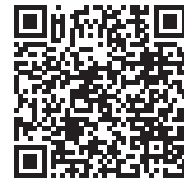
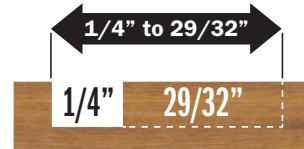

Download instructions sheets from our website

Nominal Widths	1/4"	5/16"	11/32"	3/8"	19/32"	7/16"	15/32"	1/2"	9/16"	19/32"	5/8"	21/32"	11/16"	23/32"	3/4"	25/32"	19/16"	27/32"	29/32"
Left Blade	•	•	•	•	•	•	•	•	•	•	•	•	•	•	•	•	•	•	•
Right Blade	•	•	•	•	•	•	•	•	•	•	•	•	•	•	•	•	•	•	•
Chipper 1/8"	0	0	0	1	1	1	2	2	2	3	3	3	4	4	4	4	4	4	4
Spacer 1/16"	0	1	1	0	0	1	1	0	0	1	1	0	0	1	1	0	0	1	2
Shim 0.004"	1	1	0	0	1	0	1	0	0	0	0	0	0	0	0	1	0	1	0
Shim 0.008"	0	0	1	1	0	1	0	1	1	1	1	1	1	1	0	1	0	1	1
Mag. Shim 0.012"	0	0	1	0	1	0	1	0	1	0	1	0	1	1	1	1	1	1	1
Mag. Shim 0.020"	0	0	1	0	1	0	1	0	1	0	1	0	1	0	1	0	1	0	1

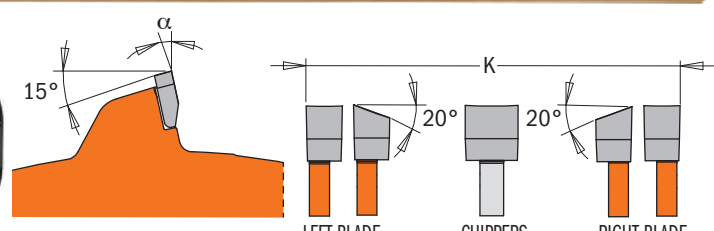

ORDER NO.	Box Icon	D inches	D mm	T	B inches	CHIPPERS	β	K inches	SPACER	α
230.520.06	3	6	152	20	5/8	4 x 1/8"	FLAT+ATB	1/4 to 29/32	2 x 1/16"	-12° Neg.
230.524.08	3	8	203	24	5/8	4 x 1/8"	FLAT+ATB	1/4 to 29/32	2 x 1/16"	-12° Neg.



**WOOD**



First ever **DADO** in compliance with **EU REGULATIONS**

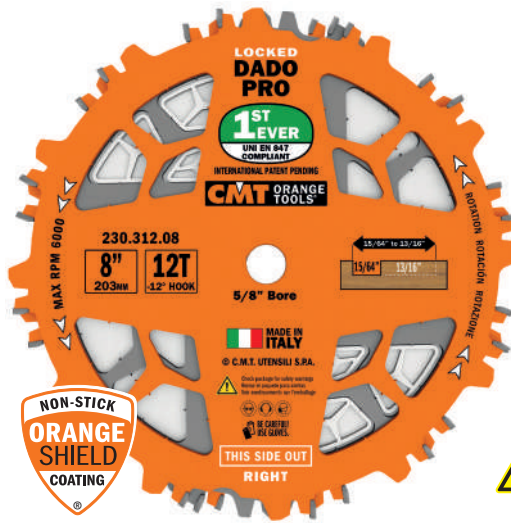

**230.312 INTERNATIONAL PATENT PENDING**

CMT is proud to introduce a brand new Locked Dado Pro Set unlike any other! This is the very first Dado ever deemed UNI EN847 compliant. This means that while the Dado is rotating, the assembled elements will never come into contact with each other! This is possible thanks to unique blade body design and 'never before seen' special "lock spacers".

**FEATURES:**

- For flat bottom grooves & virtually splinter-free cuts in solid wood, laminates & melamines, veneer plywood.
- Includes shims (plastic & magnetic) and plastic "lock spacers" set for micro-thin adjustability.
- Compatible with most radial arm saws and stationary table saws, including SAWSTOP®.
- Easy pre-assembly out of machine. Once stacked, no alignment necessary.
- Cutting teeth/ assembled elements never come in contact each other, even when brake safety system kicks in.



Always use both outside blades. Never use the chippers by themselves, or with only one outside blade. Securely fasten CMT Dado on machine using manufacturer's recommended dado arbor nut.

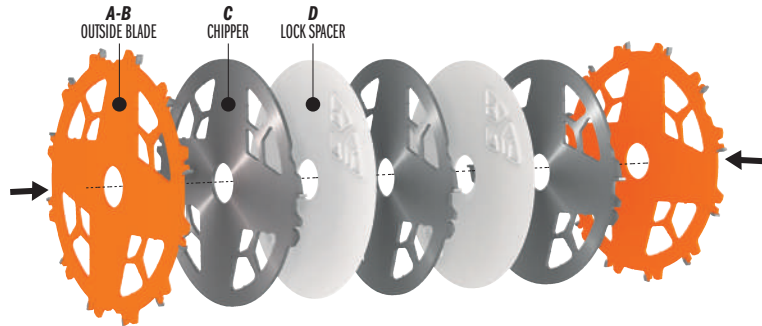

**MATERIALS**



**MACHINES**



Sturdy reusable carrying case

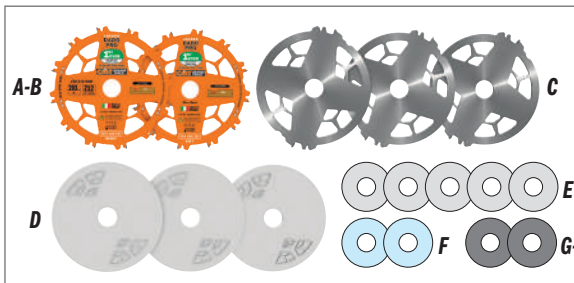

**SET INCLUDES:**

- A** - Left Outside Blade 8" (qty: 1)
- B** - Right Outside Blade 8" (qty: 1)
- C** - Chippers 1/8" (qty: 3)
- D** - Lock Spacers 1/16" (qty: 3)
- E** - Shim 0.004" (qty: 5)
- F** - Shim 0.008" (qty: 2)
- G** - Magnetic Shim 0.012" (qty: 1)
- H** - Magnetic Shim 0.020" (qty: 1)

**SPARE PART SET: 299.000.09**



INSTRUCTIONS ON FRONT & BACK OF INSERT MUST BE USED TOGETHER



Download instructions sheets from our website

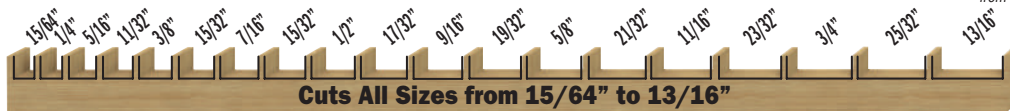

Nominal Widths	15/64"	1/4"	9/16"	11/32"	13/32"	7/16"	15/32"	1/2"	11/32"	9/16"	19/32"	5/8"	21/32"	11/16"	23/32"	3/4"	25/32"	13/16"
Left Blade	•	•	•	•	•	•	•	•	•	•	•	•	•	•	•	•	•	•
Right Blade	•	•	•	•	•	•	•	•	•	•	•	•	•	•	•	•	•	•
Chipper 1/8"	0	0	0	1	1	1	2	2	2	3	3	3	3	3	3	3	3	3
Lock Spacer 1/16"	0	0	1	1	0	0	1	1	0	0	1	1	0	1	1	2	2	3
Shim 0.004"	0	0	0	1	0	2	0	0	0	0	0	0	0	0	0	0	0	0
Shim 0.008"	0	0	0	1	2	1	2	2	2	2	2	2	2	2	2	2	2	2
Mag. Shim 0.012"	0	1	1	1	0	1	0	1	0	1	0	1	0	1	0	1	0	1
Mag. Shim 0.020"	0	0	0	1	0	1	0	1	0	1	0	1	0	1	0	1	0	1

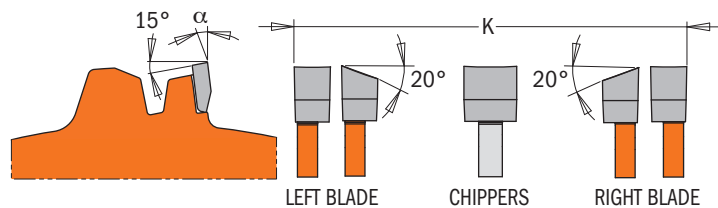

ORDER NO.		D inches	D mm	T	B inches	CHIPPERS	$\beta$	K inches	SPACER	$\alpha$
230.312.08	3	8	203	12	5/8	3 x 1/8"	FLAT+ATB	15/64 to 13/16	3 x 1/16"	-12° Neg.

# Biscuit Joiner

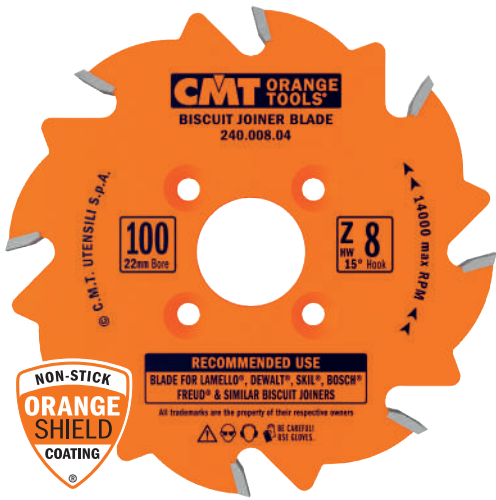

## 240-241

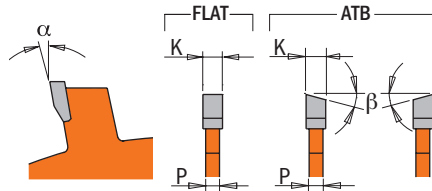

**WOOD**

### MACHINES



### APPLICATIONS

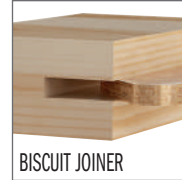

### MATERIALS



ORDER NO.	Box	D inches	D mm	T	B mm	PIN HOLE	$\beta$	K inches	P inches	$\alpha$
240.006.04	10	4	100	6	22	4/4.5 - 9.5/36	10° ATB	0.156	0.118	18°
240.008.04	10	4	100	8	22	4/4.5 - 9.5/36	10° ATB	0.156	0.118	15°
241.008.04	10	4	100	8	22	-	FLAT	0.156	0.122-0.150	15°

• Ideal for VIRUTEX®

# Calibration & Sanding Disks

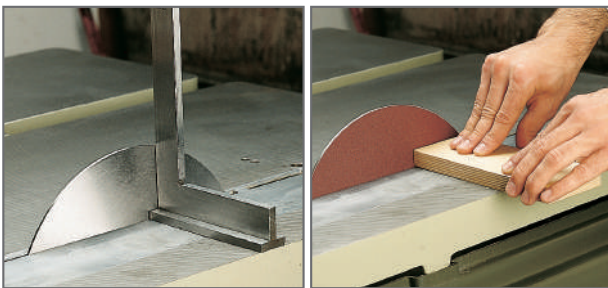

**299.11** If you're looking for fast and easy saw alignment and balancing, the cut calibration and sanding disk is for you. First, mount your calibration and sanding disk in your table saw and line it up with a square for accuracy. Then, remove the calibration and sanding disk and mount your saw blade for true precise cuts. You can also use the calibration and sanding disk as a sander by simply attaching self-stick sandpaper and installing the disk in your table saw.



ORDER NO.	Box	D inches	B inches	P inches
299.111.00	10	8	5/8	0.110
299.112.00	10	10	5/8	0.110

# Saw Blades Stabilizers



**299.10** The CMT blade stabilizer virtually eliminates rim vibration to make cleaner, straighter cuts and extend the life of your CMT saw blade. It also helps lessen noise caused by vibration during cutting.



ORDER NO.	Box	DESCRIPTION	D inches	B inches	P inches
299.101.00	5	Stabilizer (2 pcs.) for 8" blades	3	5/8	0.118
299.102.00	5	Stabilizer (2 pcs.) for 10" blades	5	5/8	0.118
299.103.00	5	Stabilizer (2 pcs.) for 12" blades	6	1	0.118

**NOTE:** for use on stationary saws only. Each order includes 2 stabilizers.

# Reduction Rings for Saw Blades

**299**

D mm	B mm	P mm	Box	ORDER NO.	D mm	B mm	P mm	Box	ORDER NO.
15.87	10	1.2	10	299.218.00	25.4	22.2	2.3	10	299.219.00
15.87	12.7	1.2	10	299.217.00	30	15.87	1.4	10	299.211.00
20	15.87	1.4	10	299.243.00	30	25.4	1.6	10	299.405.00
22.2	15	1.4	10	299.237.00	30	25.4	2.0	10	299.212.00
22.2	20	1.4	10	299.238.00					
25.4	15.87	1.4	10	299.216.00					
25.4	19.05	1.4	10	299.213.00					
25.4	20	2.3	10	299.220.00					
25.4	22.2	1.4	10	299.239.00					



# XTREME - DEMOLITION, FRAMING & FINISH

Designed for the professional woodworker and construction craftsman  
CMT's **XTREME** quality blade line delivers an outstanding cut,  
minimal stock removal and creates the least possible stress to your saw!



## NON-STICK ORANGE SHIELD® PTFE-COATED

- Prevents overheating
- Protects against corrosion and rust
- Reduces resin build-up
- Reduces blade drag
- Improves performance and cutting life



**MADE IN ITALY**

- ★★★★★ INDUSTRIAL CHROME®
- ★★★★★ INDUSTRIAL ORANGE SHIELD®
- ★★★★★ ITK XTREME
- ★★★★ ITK PLUS®
- ★★★ CMT CONTRACTOR TOOLS®



**LASER-CUT PREMIUM-QUALITY STEEL PLATE**  
Made of 46-48 HRC precision German steel which is laser-cut to provide tighter tolerances ensuring longer life and more accurate cuts.



## LOW MASS PLATE DESIGN

Patented design that reduces blade mass minimizes heat and substantially increases cutting efficiency with cordless and corded saws. More cuts. Less battery.

**ZERO GRAVITY**

**XTREME FRAMING**

CONSTRUCCIÓN-CARPINTERO / CHARPENTERIE

MAX RPM 8300



7 1/4" 184MM

24T

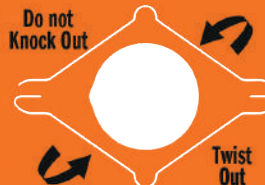

5/8" Bore



INTERNATIONAL PATENT PENDING

**CMT ORANGE TOOLS®**

# 250.324.07



**BE CAREFUL! USE GLOVES.**



Check package for safety warnings  
Reviser el paquete para alertas  
Voir avertissements sur l'emballage



**HI-DENSITY INDUSTRIAL CHROME CARBIDE**

INDUSTRIAL CHROMIUM MICROGRAIN CARBIDE  
Cutting teeth are made from a specially formulated chromium micrograin carbide which stays sharper longer by reducing cutting edge abrasion, improving cut quality and tool life.

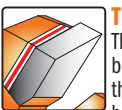

## TRI-METAL BRAZING

The Silver-Copper-Silver tri-metal brazing process lets the teeth withstand the severe impact caused by cutting harder woods and composite material.



## PRECISION MIRROR FINISH SHARPENING

Each tooth is ground to razor sharp precision on a multi-axis CNC machine which creates perfect edge angles, guaranteeing extra-clean cuts and extended life. Featuring less than 0.25 µm R max in edge roughness.

**INNOVATIONS**

INTERNATIONAL PATENT PENDING



**ZERO GRAVITY**

**BEST EVER AT NAIL CUTTING**

## DEMOLITION



**EXCLUSIVE SECURED TOOTH GEOMETRY**  
- BETTER HANDLES IMPACT WITH NAILS  
- CUTS MORE NAILS THAN COMPETITORS

Engineered to ensure the longest tool life under the most demanding conditions. Tips are brazed deep inside the blade plate for superior nail impact resistance.



**PTIA 2023**  
AWARD WINNER

2023 PRO TOOL INNOVATION AWARDS  
CIRCULAR SAW BLADE WINNER

"RECOGNITION FOR EXCELLENT VALUE, ADVANCED FEATURES AND INNOVATION"  
[www.protoolinnovationawards.com](http://www.protoolinnovationawards.com)



## FRAMING - FINISH

**EXCLUSIVE SECURED TOOTH GEOMETRY**  
- VERY EFFICIENT CHIP EVACUATION  
- HANDLES THICKER MATERIALS  
WITH MINIMUM EFFORT

New gullet design is more efficient at clearing wood chips quickly. The saw blade becomes lighter to feed, is faster in the cut and handles thicker materials better.



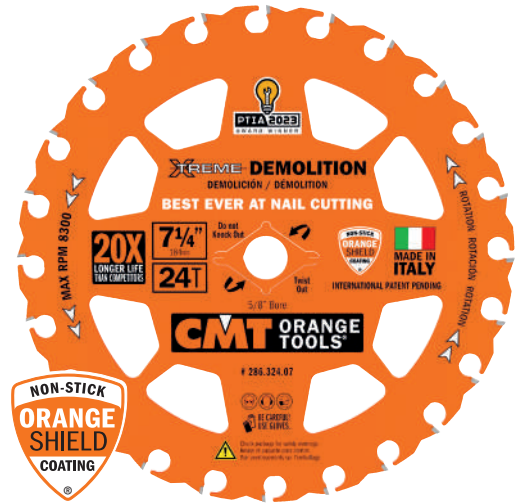

**286 X-TREME-DEMOLITION**



**INNOVATIONS**  
INTERNATIONAL PATENT PENDING



**WOOD & NAILS**



**EXCLUSIVE SECURED TOOTH GEOMETRY**  
- BETTER HANDLES IMPACT WITH NAILS  
- CUTS MORE NAILS THAN COMPETITORS

Engineered to ensure the longest tool life under the most demanding conditions. Tips are brazed deep inside the blade plate for superior nail impact resistance.



**LOW MASS PLATE DESIGN**  
Patented design that reduces blade mass minimizes heat and substantially increases cutting efficiency with cordless and corded saws. More cuts. Less battery.



**PTIA 2023**  
AWARD WINNER

**2023 PRO TOOL INNOVATION AWARDS**  
**CIRCULAR SAW BLADE WINNER**  
"RECOGNITION FOR EXCELLENT VALUE, ADVANCED FEATURES AND INNOVATION"  
[www.protoolinnovationawards.com](http://www.protoolinnovationawards.com)

**BEST EVER AT NAIL CUTTING**

**MACHINES**



Blade diameter compatibility is contingent on machine type.

**MATERIALS**



Watch the video on



ORDER NO.	PACKAGING		inches	D	mm	T	B	$\beta$	K	P	$\alpha$
286.760.24H	cardboard box	1	6-1/4	160	24	20mm	5° ATB	0.090	0.049	5°	
286.765.24H	cardboard box	1	6-1/2	165	24	20mm	5° ATB	0.090	0.049	5°	
286.324.07	clamshell	3	7-1/4	184	24	5/8	5° ATB	0.090	0.049	5°	

- Ideal for FESTOOL®
- Ideal for Track Saws

**286.324.06-X10**  
(BULK PACK 10 PCS.)



**20X**  
LONGER LIFE  
THAN COMPETITORS

**286.324.07-X10**  
(BULK PACK 10 PCS.)



ORDER NO.	PACKAGING		inches	D	mm	T	B	$\beta$	K	P	$\alpha$
286.324.06-X10	Bulk Pack 10 pcs.	50	6-1/2	165	24	5/8	5° ATB	0.090	0.049	5°	
286.324.07-X10	Bulk Pack 10 pcs.	50	7-1/4	184	24	5/8	5° ATB	0.090	0.049	5°	



**X10** (10-PC. BULK MASTERPACK)

**250XTREME FRAMING**



**WOOD**

**INNOVATIONS**  
INTERNATIONAL PATENT PENDING



**EXCLUSIVE SECURED TOOTH GEOMETRY**  
- VERY EFFICIENT CHIP EVACUATION  
- HANDLES THICKER MATERIALS  
WITH MINIMUM EFFORT

New gullet design is more efficient at clearing wood chips quickly. The saw blade becomes lighter to feed, is faster in the cut and handles thicker materials better.



**LOW MASS PLATE DESIGN**  
Patented design that reduces blade mass minimizes heat and substantially increases cutting efficiency with cordless and corded saws. More cuts. Less battery.



**MACHINES**

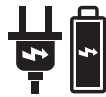

OPTIMIZED FOR 7-1/4" CORDED OR CORDLESS

**EFFORTLESS CUTS**

**DON'T LET YOUR BLADE BE A DRAG...**

Blade diameter compatibility is contingent on machine type.

**MATERIALS**



ORDER NO.	PACKAGING		inches	D mm	T	B inches	$\beta$	K inches	P inches	$\alpha$
250.324.07	clamshell	3	7-1/4	184	24	5/8	5° ATB	0.070	0.048	15°
250.324.07-X10	10-pc. bulk masterpack	10	7-1/4	184	24	5/8	5° ATB	0.070	0.048	15°

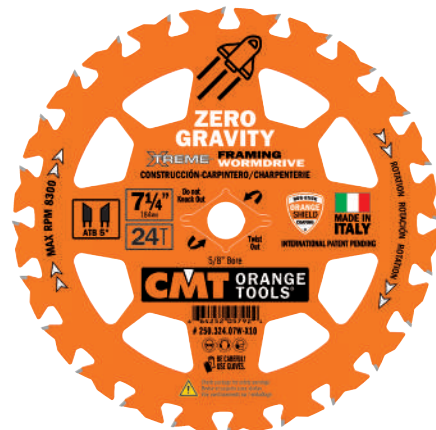

**250XTREME FRAMING WORMDRIVE**



**250.324.07W-X10**  
X10 (10-PC. BULK MASTERPACK)

ORDER NO.	PACKAGING		inches	D mm	T	B inches	$\beta$	K inches	P inches	$\alpha$
250.324.07W-X10	10-pc. bulk masterpack	10	7-1/4	184	24	5/8	5° ATB	0.070	0.048	15°



**251 X-TREME FINISH**



**WOOD**

**INNOVATIONS**  
INTERNATIONAL PATENT PENDING



**EXCLUSIVE SECURED TOOTH GEOMETRY**  
- VERY EFFICIENT CHIP EVACUATION  
- HANDLES THICKER MATERIALS  
WITH MINIMUM EFFORT

New gullet design is more efficient at clearing wood chips quickly. The saw blade becomes lighter to feed, is faster in the cut and handles thicker materials better.



**LOW MASS PLATE DESIGN**  
Patented design that reduces blade mass minimizes heat and substantially increases cutting efficiency with cordless and corded saws. More cuts. Less battery.

**MACHINES**

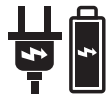

OPTIMIZED FOR 7-1/4" CORDED OR CORDLESS

**EFFORTLESS CUTS**

**DON'T LET YOUR BLADE BE A DRAG...**

Blade diameter compatibility is contingent on machine type.

**MATERIALS**

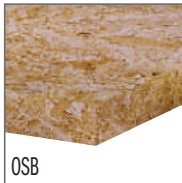

**X10** (10-PC. BULK MASTERPACK)

ORDER NO.	PACKAGING		D inches	D mm	T	B inches	$\beta$	K inches	P inches	$\alpha$
251.340.07	clamshell	1	7-1/4	184	40	5/8	5° ATB	0.070	0.048	15°

ORDER NO.	PACKAGING		D inches	D mm	T	B inches	$\beta$	K inches	P inches	$\alpha$
251.340.07-X10	10-pc. bulk masterpack	3	7-1/4	184	40	5/8	5° ATB	0.070	0.048	15°



# ITK XTREME

Designed for the professional woodworker and construction craftsman CMT's THIN-KERF quality blade line delivers an outstanding cut, minimal stock removal and creates the least possible stress to your saw!



## CHROME® COATING

Chrome plated blade:

- protects the tool against corrosion, rust and accumulation of resin and residues
- guarantees longer tool life
- power absorbed by motor is significantly reduced
- tool moves smoothly throughout cutting operation
- tool maintenance fast and easy
- surface hardness: 380/400 Vickers



**MADE IN ITALY**

- ★ ★ ★ ★ ★ INDUSTRIAL CHROME®
- ★ ★ ★ ★ ★ INDUSTRIAL ORANGE SHIELD®
- ★ ★ ★ ★ ★ ITK XTREME
- ★ ★ ★ ★ ITK PLUS®
- ★ ★ CMT CONTRACTOR TOOLS®

**HQ STEEL**

## LASER-CUT PREMIUM QUALITY STEEL PLATE

Made of 46-48 HRC precision German steel which is laser-cut to provide tighter tolerances ensuring longer life and more accurate cuts.

## CMT XTREME BALANCING



### CMT XTREME BALANCING™

This system allows for extremely accurate dynamic balancing of the blade, several orders of magnitude above and beyond that which is currently available in the marketplace.

™TRADEMARK & INT. PAT. PEND.



**ITK XTREME**  
**Combination**  
Combinada  
Combinée



**10"**  
254mm

**50T**  
5/8" Bore



## FLATNESS OF BODIES & BALANCING

Blade body flatness, obtained via straightening processes, guarantee exceptionally reduced tolerances. Balancing performed on all saw blades guarantees maximum stability.

## TENSIONING RING

A visible tension ring on the blade body provides stability during cut and perfect concentricity during rotation.

**CMT ORANGE TOOLS**

# 256.050.10



MAX RPM 7600

Check package for safety warnings  
Revise el paquete para alertas  
Voir avertissements sur l'emballage

## PRECISION MIRROR FINISH SHARPENING

Each tooth is precision ground on a multi-axis CNC machine creating perfect edge angles and guaranteeing extra-clean cuts and extended life. Featuring less than 0.25 µm R max in edge roughness.



## FILLED SLOTS

### LASER-CUT SLOTS FILLED WITH SOUND-DAMPENING MATERIAL

Slots filled with polyurethane reduce vibrations and noise (25% less than standard saw blades) improving cut quality and extending blade life. Located close to the toothed crown, these slots act as shock absorbers isolating the teeth from vibration. In full compliance with National Noise Emission Standards and Regulations.



## INDUSTRIAL CHROME CARBIDE

Cutting teeth are made from a specially formulated chrome carbide which stays sharper longer by reducing cutting edge abrasion, improving cut quality and tool life.

## LASER-CUT HEAT EXPANSION SLOTS

Engineered to allow blade expansion from the stress of centrifugal force and heat build-up during heavy use, preventing blade warping.



## TRI-METAL BRAZING

The Silver-Copper-Silver tri-metal brazing process lets the teeth withstand the severe impact caused by cutting harder woods and composite material.



**PTIA 2023**

AWARD WINNER  
**2023 PRO TOOL INNOVATION AWARDS**  
TABLE SAW BLADE WINNER

"RECOGNITION FOR EXCELLENT VALUE, ADVANCED FEATURES AND INNOVATION"  
[www.protoolinnovationawards.com](http://www.protoolinnovationawards.com)





**226 ITK XREME**



**METAL & STEEL**

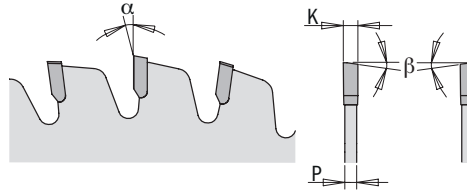

**MACHINES**

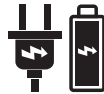

OPTIMIZED FOR 7-1/4" CORDED OR CORDLESS

Blade diameter compatibility is contingent on machine type.

**MATERIALS**



Suggested for Stainless steel of common use, such as 302, 303 and 304.  
With higher degrees of hardness, performance is not guaranteed (e.g. 316)

For specific details regarding suggested materials, please check blade label.

ORDER NO.	PACKAGING		inches	D mm	T	B inches	$\beta$	K inches	P inches	$\alpha$
226.348.07	clamshell	3	7-1/4	184	48	5/8	8° FWF	0.080	0.065	0°



**257 ITK XREME**

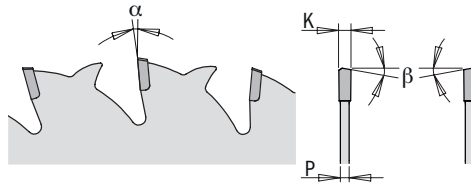

**MACHINES**

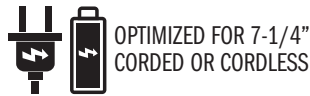

Blade diameter compatibility is contingent on machine type.

**MATERIALS**



For specific details regarding suggested materials, please check blade label.

ORDER NO.	PACKAGING		D		T	B	$\beta$	K	P	$\alpha$
			inches	mm		inches		inches	inches	
257.036.07	clamshell	3	7-1/4	184	36	5/8	MATB	0.067	0.049	5°



## 250 ITK XTREME

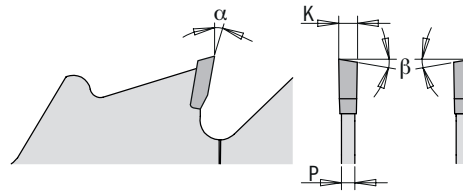

### MACHINES



Blade diameter compatibility is contingent on machine type.

### APPLICATIONS



### MATERIALS



For specific details regarding suggested materials, please check blade label.

ORDER NO.	PACKAGING		D inches	D mm	T	B inches	β	K inches	P inches	α
250.024.08	clamshell	3	8-8/1-4	210	24	5/8	15° ATB	0.082	0.048	20°
250.024.10	clamshell	3	10	254	24	5/8	10° ATB	0.102	0.071	10°

# General Purpose

new

**CMT ORANGE TOOLS®**



## 251 ITK XTREME

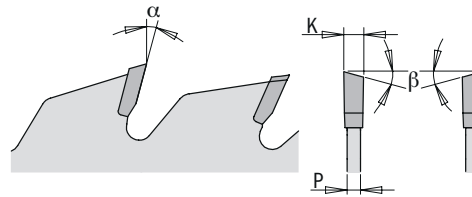

**WOOD**

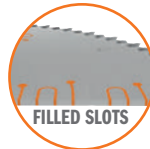

### MACHINES

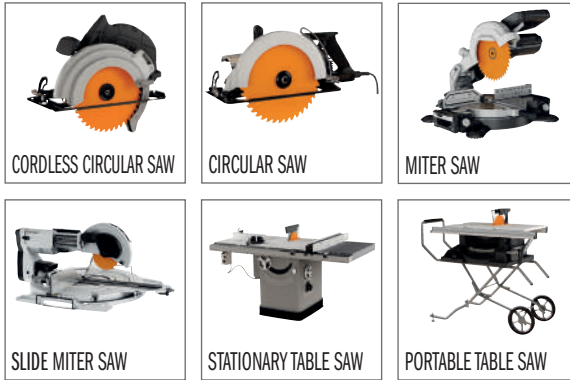

OPTIMIZED FOR 8-1/4" & 12" CORDED OR CORDLESS

Blade diameter compatibility is contingent on machine type.

### APPLICATIONS

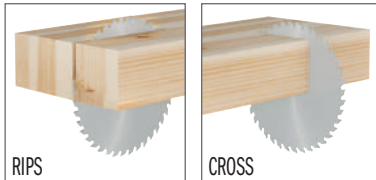

### MATERIALS

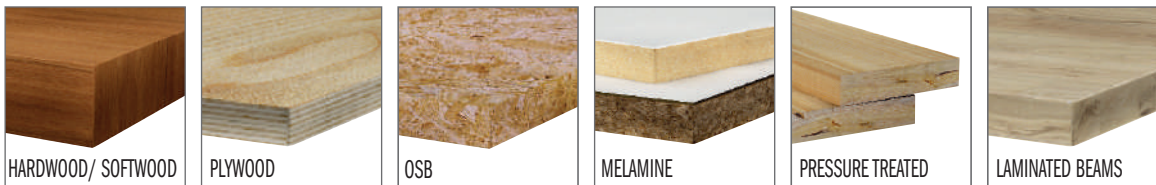

For specific details regarding suggested materials, please check blade label.

ORDER NO.	PACKAGING	3	D		T	B	β	K	P	α
			inches	mm						
251.040.08	clamshell	3	8-8/1-4	210	40	5/8	15° ATB	0.094	0.063	10°
251.042.10	clamshell	3	10	254	40	5/8	15° ATB	0.110	0.071	15°
251.045.12	clamshell	3	12	305	48	1	15° ATB	0.110	0.071	-10° Neg.



# Combination

new

**CMT ORANGE TOOLS®**



**256 ITK XTREME**



**WOOD**

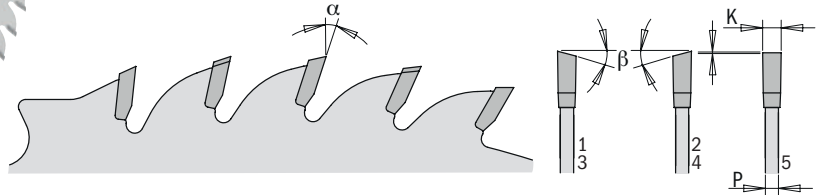

## MACHINES

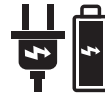

OPTIMIZED FOR 10" & 12"  
CORDED OR CORDLESS

Blade diameter compatibility is contingent on machine type.

## APPLICATIONS

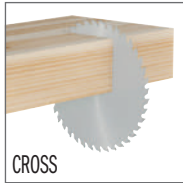

## MATERIALS



**PTIA 2023**  
AWARD WINNER

2023 PRO TOOL INNOVATION AWARDS  
TABLE SAW BLADE WINNER

"RECOGNITION FOR EXCELLENT VALUE, ADVANCED FEATURES AND INNOVATION"  
[www.protoolinnovationawards.com](http://www.protoolinnovationawards.com)

ORDER NO.	PACKAGING		D		T	B	$\beta$	K	P	$\alpha$
			inches	mm		inches		inches	inches	
256.050.10	clamshell	3	10	254	50	5/8	4 ATB 15°+ 1 FLAT	0.102	0.071	15°
256.060.12	clamshell	3	12	305	60	1	4 ATB 15°+ 1 FLAT	0.102	0.071	15°



**252 ITK XTREME**

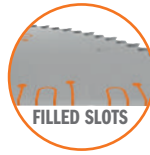
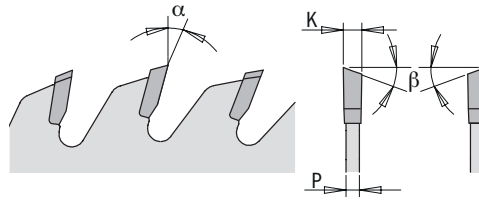

**MACHINES**

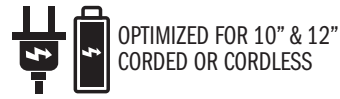

Blade diameter compatibility is contingent on machine type.

**APPLICATIONS**



**MATERIALS**



For specific details regarding suggested materials, please check blade label.

ORDER NO.	PACKAGING		D		T	B	β	K	P	α
			inches	mm						
252.060.10	clamshell	3	10	254	60	5/8	20° ATB	0.102	0.071	15°
252.072.12	clamshell	3	12	305	80	1	20° ATB	0.118	0.087	15°

# Fine Finish Compound Sliding

new

**CMT ORANGE TOOLS®**



## 253 ITK XTREME



**WOOD**

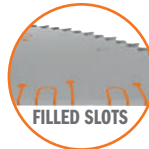
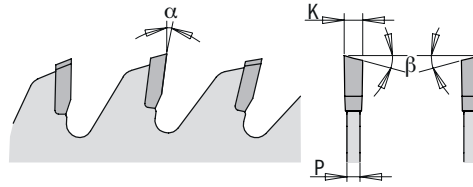

### MACHINES

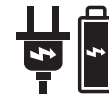

OPTIMIZED FOR 10" & 12" CORDED OR CORDLESS

Blade diameter compatibility is contingent on machine type.

### APPLICATIONS

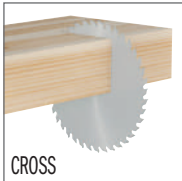

### MATERIALS

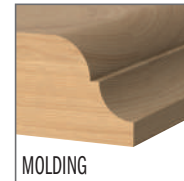
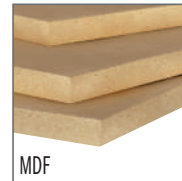

For specific details regarding suggested materials, please check blade label.

ORDER NO.	PACKAGING		D		T	B	$\beta$	K	P	$\alpha$
			inches	mm						
253.060.08	clamshell	3	8/1-2	216	60	5/8	15° ATB	0.094	0.055	7°
253.060.10	clamshell	3	10	254	60	5/8	15° ATB	0.102	0.071	7°
253.072.12	clamshell	3	12	305	72	1	15° ATB	0.102	0.071	7°
253.096.14	clamshell	3	14	355	96	1	15° ATB	0.110	0.071	7°



**255 ITK XTREME**

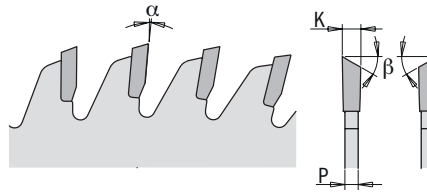

**MACHINES**

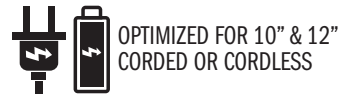

Blade diameter compatibility is contingent on machine type.

**APPLICATIONS**



**MATERIALS**

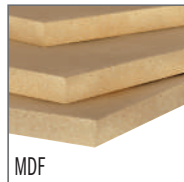

ORDER NO.	PACKAGING		D		T	B	$\beta$	K	P	$\alpha$
			inches	mm						
255.080.10	clamshell	3	10	254	80	5/8	30° Hi-ATB	0.110	0.071	5°
255.096.12	clamshell	3	12	305	96	1	30° Hi-ATB	0.102	0.071	-5° Neg.



# Non-Ferrous & Laminate

new

**CMT ORANGE TOOLS**



## 254 ITK XTREME

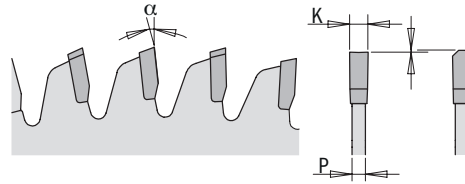

**NON-FERROUS**



### MACHINES

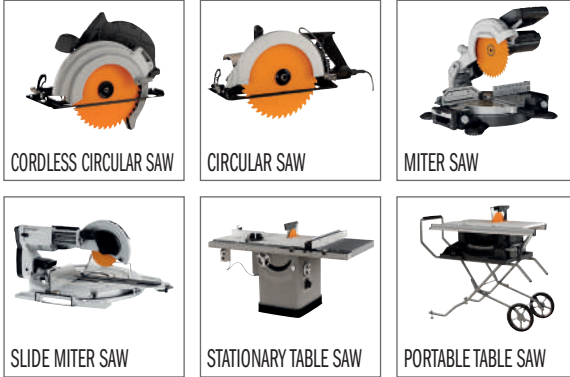

OPTIMIZED FOR 10" & 12" CORDED OR CORDLESS

Blade diameter compatibility is contingent on machine type.

### MATERIALS

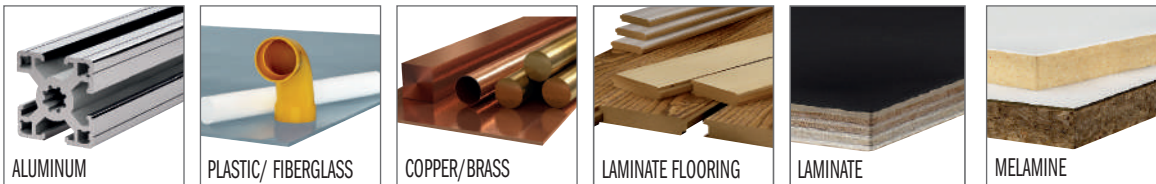

For specific details regarding suggested materials, please check blade label.

ORDER NO.	PACKAGING		inches	D mm	T	B inches	$\beta$	K inches	P inches	$\alpha$
254.056.07	clamshell	3	7-1/4	184	60	5/8	TCG	0.098	0.063	-6° Neg.
254.080.10	clamshell	3	10	254	80	5/8	TCG	0.102	0.071	-6° Neg.
254.096.12	clamshell	3	12	305	96	1	TCG	0.102	0.071	-6° Neg.

# ITK PLUS®

Designed for the professional contractor and remodeler, the **CMT ITK PLUS®** thin-kerf coated blade line delivers a clean, fast and effortless cut through wood and wood composite. The **ITK PLUS®** line provides an exceptional balance of features maximizing value.



## NON-STICK ORANGE SHIELD® PTFE-COATED

- Prevents overheating
- Protects against corrosion and rust
- Reduces resin build-up
- Reduces blade drag
- Improves performance and cutting life



- ★★★★★ INDUSTRIAL CHROME®
- ★★★★★ INDUSTRIAL ORANGE SHIELD®
- ★★★★★ ITK XTREME
- ★★★★★ ITK PLUS®
- ★★★ CMT CONTRACTOR TOOLS®



## HEAVY-DUTY LASER CUT PLATE

Cut from the finest steel and hardened to 44 HRC, these thin, yet strong blades ensure longer life and exceptional cutting precision.

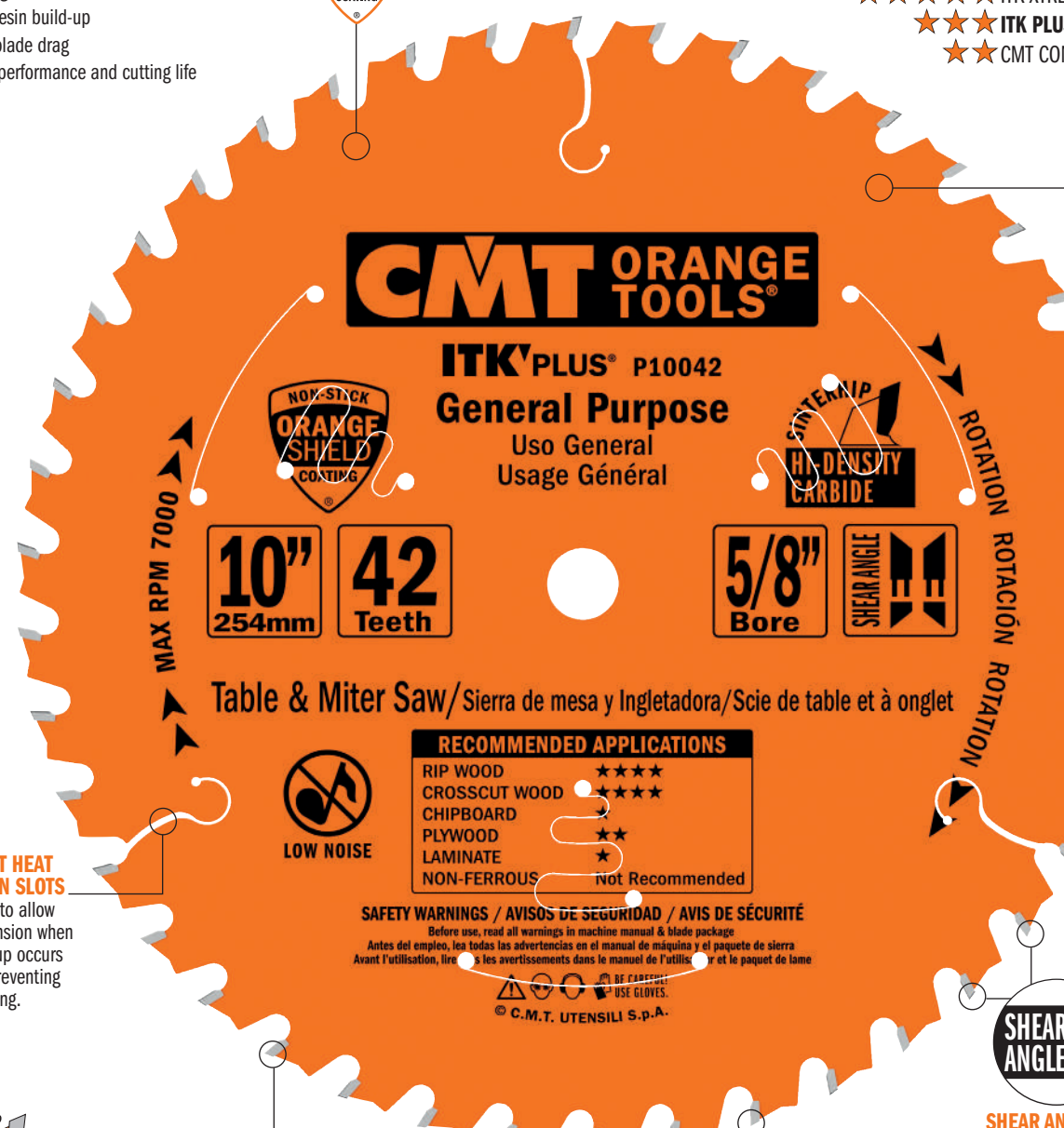

## LASER-CUT HEAT EXPANSION SLOTS

Engineered to allow blade expansion when heat build-up occurs from use, preventing blade warping.



## INDUSTRIAL SINTERHIP HI-DENSITY CARBIDE

The SinterHIP method (Hot Isostatic Pressing) uses high temperature (up to 3500°F) and high pressure (up to 1500 psi) to fully consolidate carbide thereby resulting in a porosity-free product ensuring longer cutting life over traditional carbide.

## SUPER THIN-KERF DESIGN

A remarkably thin-kerf reduces material waste as well as stress on the saw promising reliable, good-quality performance.



## SHEAR ANGLE SHARPENING

The shear angle grind on the face front of the teeth produces smooth cuts, reducing the cutting force, improving cutting speed and setting new standard for performance.

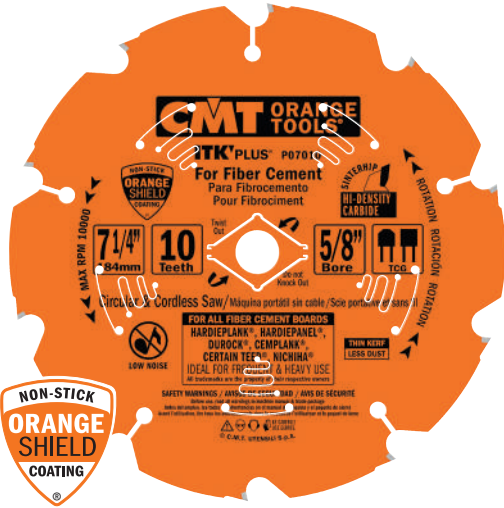

**P07010 ITK PLUS®**

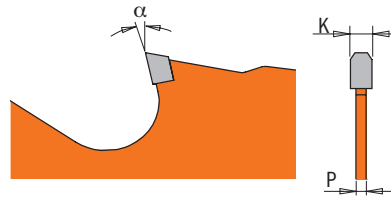

**MULTI-MATERIALS**

**MACHINES**





Blade diameter compatibility is contingent on machine type.

**MATERIALS**



**Ideal for:**  
 HARDIEPLANK®  
 HARDIEPANEL®  
 DUROCK®  
 CEMPLANK®  
 CERTAIN TEED®  
 NICHIIHA®

ORDER NO.	PACKAGING		D		T	B	β	K	P	α
			inches	mm		inches		inches	inches	
<b>P07010</b>	clamshell	<b>10</b>	7-1/4	184	10	5/8 	TCG	0.071	0.055	12°

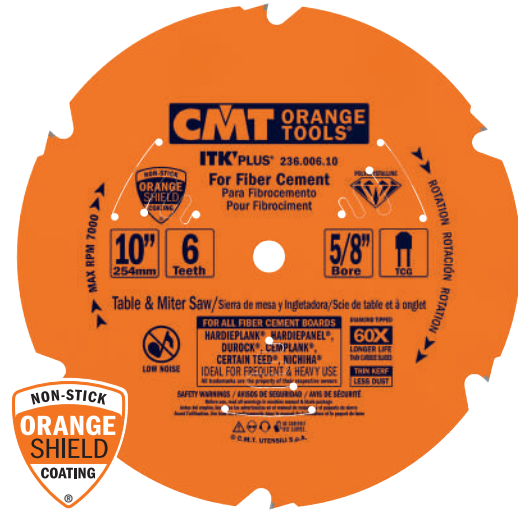

## 236 ITK PLUS®

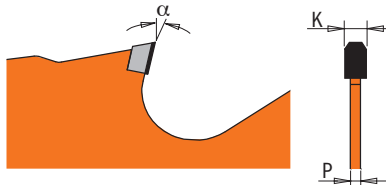

**60X**  
 LONGER LIFE  
 THAN CARBIDE



**MULTI-MATERIALS**

### MACHINES



Blade diameter compatibility is contingent on machine type.

### MATERIALS



**X10 (10-PC. BULK MASTERPACK)**

ORDER NO.	PACKAGING		D		T	B	PIN HOLE	$\beta$	K	P	$\alpha$
			inches	mm		inches			inches	inches	
236.085.06G	clamshell	10	3-3/8	85	6	15mm		TCG	0.071	0.055	12°
236.004.06	clamshell	10	6-1/2	165	4	5/8		TCG	0.071	0.055	12°
236.165.04H	clamshell	10	6-1/2	165	4	20mm (+5/8)	2/6/32	TCG	0.071	0.055	12°
236.004.07	clamshell	10	7-1/4	184	4	5/8		TCG	0.071	0.055	12°
236.006.10	clamshell	10	10	254	6	5/8		TCG	0.087	0.063	12°
236.008.12	clamshell	5	12	305	8	1		TCG	0.087	0.063	12°
236.160.04H	clamshell	10		160	4	20mm	2/6/32	TCG	0.094	0.071	12°
236.190.04M	clamshell	10		190	4	30mm	2/7/42	TCG	0.094	0.071	12°
236.210.12M	clamshell	10		210	12	30mm	2/7/42	TCG	0.094	0.071	12°

- Ideal for FESTOOL®
- Ideal for Track Saws

ORDER NO.	PACKAGING		D		T	B	$\beta$	K	P	$\alpha$
			inches	mm		inches		inches	inches	
236.004.07-X10	10-pc. bulk masterpack	30	7-1/4	184	4	5/8	TCG	0.071	0.055	12°



# Fast Framing

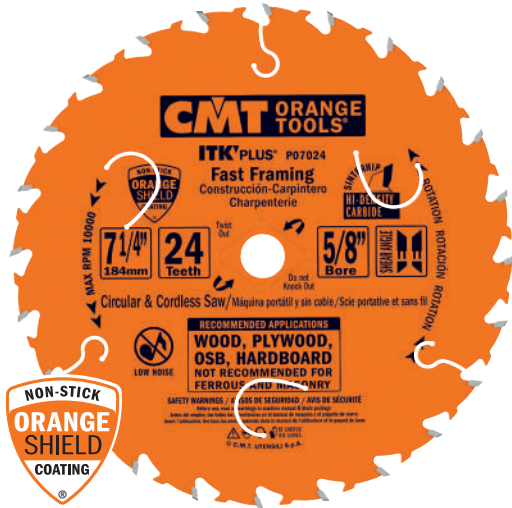

**P05018 - P06018**  
**P07024 - P08024**  
**271 ITK PLUS®**



**WOOD**

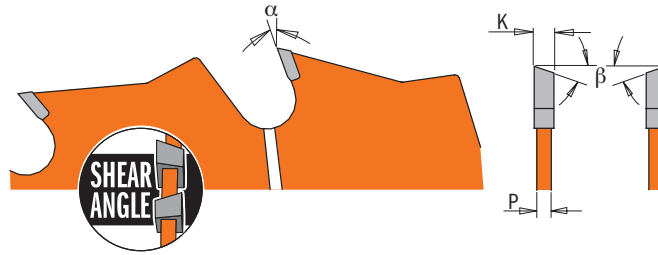

## MACHINES



Blade diameter compatibility is contingent on machine type.

## APPLICATIONS

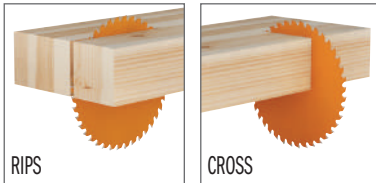

## MATERIALS



**X10 (10-PC. BULK MASTERPACK)**

ORDER NO.	PACKAGING		inches	D	mm	T	B	inches	$\beta$	K	inches	P	inches	$\alpha$
<b>P05018</b>	clamshell	10	5-3/8	136.5	18	10mm			10° ATB+Shear	0.059	0.039	20°		
<b>P06018</b>	clamshell	10	6-1/2	165	18	5/8			10° ATB+Shear	0.067	0.039	20°		
<b>P07024</b>	clamshell	10	7-1/4	184	24	5/8			10° ATB+Shear	0.067	0.039	20°		
<b>P08024</b>	clamshell	10	8-8-1/4	203	24	5/8			10° ATB+Shear	0.067	0.039	20°		
<b>271.160.24H</b> ●	clamshell	10		160	24	20mm (+16)			10° ATB+8° Shear	0.071	0.047	18°		
<b>271.165.24H</b> ■	clamshell	10	6-1/2	165	24	20mm (+5/8)			10° ATB+8° Shear	0.067	0.043	18°		

● Ideal for **FESTOOL®**      ■ Ideal for **Track Saws**

ORDER NO.	PACKAGING		inches	D	mm	T	B	inches	$\beta$	K	inches	P	inches	$\alpha$
<b>P06018-X10</b>	10-pc. bulk masterpack	30	6-1/2	165	18	5/8			10° ATB+Shear	0.067	0.039	20°		
<b>P07018-X10</b>	10-pc. bulk masterpack	30	7-1/4	184	18	5/8			10° ATB+Shear	0.067	0.039	20°		
<b>P07024-X10</b>	10-pc. bulk masterpack	30	7-1/4	184	24	5/8			10° ATB+Shear	0.067	0.039	20°		

# Ultimate Fast Framing V-DRIVE



## P065 - P075 ITK<sup>PLUS</sup>



**WOOD WITH NAILS**

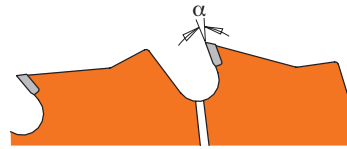

For framing/decking faster cuts thanks to special V-DRIVE teeth.

### MACHINES



Blade diameter compatibility is contingent on machine type.

### APPLICATIONS

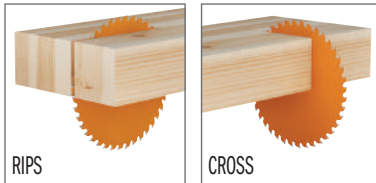

### MATERIALS

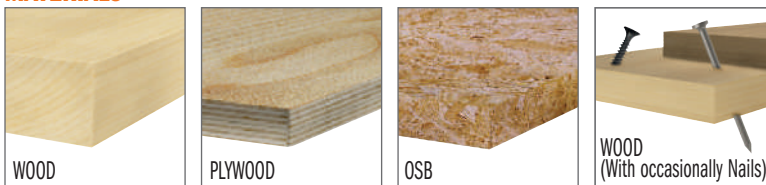

For specific details regarding suggested materials, please check blade label.



**X10** (10-PC. BULK MASTERPACK)

ORDER NO.	PACKAGING		D	T	B	$\beta$	K	P	$\alpha$	
			inches	mm	inches		inches	inches		
<b>P06524-X10</b>	10-pc. bulk masterpack	30	6-1/2	165	24	5/8	V-DRIVE	0.067	0.039	15°
<b>P07524-X10</b>	10-pc. bulk masterpack	30	7-1/4	184	24	5/8	V-DRIVE	0.067	0.039	15°

# Finish



**P06036 - P07040**  
**P08040 - 272 ITK PLUS®**



**WOOD**

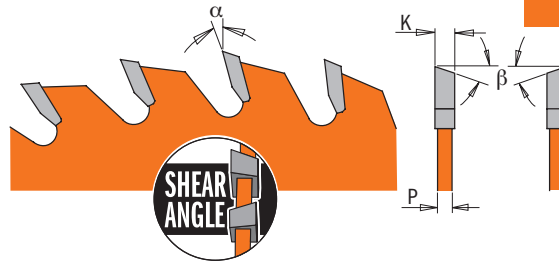

## MACHINES



Blade diameter compatibility is contingent on machine type.

## APPLICATIONS

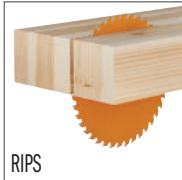

## MATERIALS



**X10** (10-PC. BULK MASTERPACK)

ORDER NO.	PACKAGING		D		T	B	$\beta$	K	P	$\alpha$
			inches	mm		inches		inches	inches	
<b>P06036</b>	clamshell	10	6-1/2	165	36	5/8	10° ATB+Shear	0.067	0.039	20°
<b>P07040</b>	clamshell	10	7-1/4	184	40	5/8	10° ATB+Shear	0.067	0.039	18°
<b>P08040</b>	clamshell	10	8-8-1/4	203	40	5/8	10° ATB+Shear	0.067	0.039	20°
<b>272.115.24</b>	clamshell	10	4-1/2	115	24	3/8	10° ATB+8° Shear	0.059	0.039	20°
<b>272.160.40H</b>	clamshell	10		160	40	20mm (+16)	10° ATB+8° Shear	0.071	0.047	16°
<b>272.165.36H</b>	clamshell	10	6-1/2	165	36	20mm (+5/8)	10° ATB+8° Shear	0.067	0.043	20°

■ Ideal for Track Saws

ORDER NO.	PACKAGING		D		T	B	$\beta$	K	P	$\alpha$
			inches	mm		inches		inches	inches	
<b>P07040-X10</b>	10-pc. bulk masterpack	30	7-1/4	184	40	5/8	10° ATB+Shear	0.067	0.039	18°



## P065 - P075 ITK PLUS®



**WOOD WITH NAILS**



For finish faster cuts thanks to special V-DRIVE teeth.

### MACHINES



Blade diameter compatibility is contingent on machine type.

### APPLICATIONS



### MATERIALS



For specific details regarding suggested materials, please check blade label.



**X10 (10-PC. BULK MASTERPACK)**

ORDER NO.	PACKAGING		D	T	B	$\beta$	K	P	$\alpha$	
			inches	mm	inches		inches	inches		
P06540-X10	10-pc. bulk masterpack	30	6-1/2	165	40	5/8	V-DRIVE	0.067	0.039	15°
P07540-X10	10-pc. bulk masterpack	30	7-1/4	184	40	5/8	V-DRIVE	0.067	0.039	15°



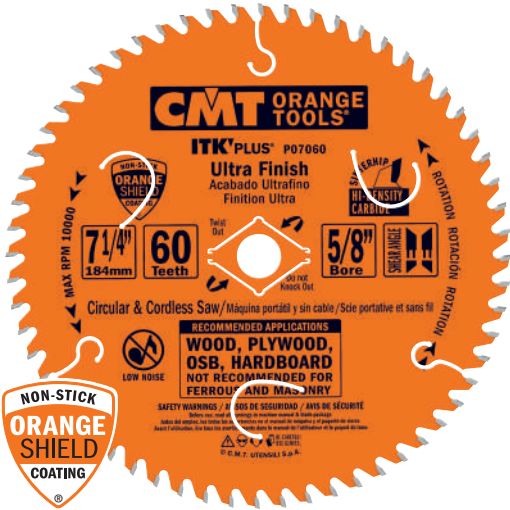

**P06060 - P07060**  
**273 ITK PLUS®**



**WOOD**

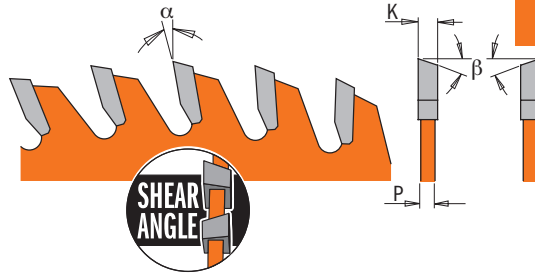

**MACHINES**



Blade diameter compatibility is contingent on machine type.

**APPLICATIONS**

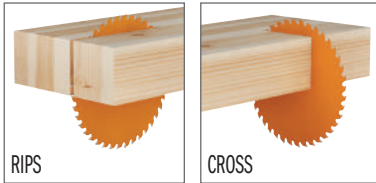

**MATERIALS**



**X10 (10-PC. BULK MASTERPACK)**

ORDER NO.	PACKAGING		D		T	B	PIN HOLE	β	K	P	α
			inches	mm		inches			inches	inches	
<b>P06060</b>	clamshell	10	6-1/2	165	60	5/8		10° ATB+Shear	0.067	0.039	5°
<b>P07060</b>	clamshell	10	7-1/4	184	60	5/8		10° ATB+Shear	0.067	0.039	5°
<b>273.050.20D</b>	clamshell	10		50	20	10mm	-	10° ATB	0.043	0.031	15°
<b>273.080.36D</b>	clamshell	10		80	36	10mm	-	10° ATB	0.063	0.039	15°
<b>273.160.56H</b>	clamshell	10		160	56	20mm (+16)	2/6/32	10° ATB+8° Shear	0.071	0.047	12°
<b>273.165.56H</b>	clamshell	10	6-1/2	165	56	20mm (+5/8)	2/6/32	15° ATB+8° Shear	0.063	0.039	12°

- Ideal for **FESTOOL®**
- Ideal for **PROXXON®** (Materials: Wood, Plastic, Non-ferrous)
- Ideal for **Track Saws**

ORDER NO.	PACKAGING		D		T	B	β	K	P	α
			inches	mm		inches		inches	inches	
<b>P07060-X10</b>	10-pc. bulk masterpack	30	7-1/4	184	60	5/8	10° ATB+Shear	0.067	0.039	5°



**HEAVY DUTY**

**P07140-X10 ITK PLUS®**

**HQ STEEL**



**WOOD**

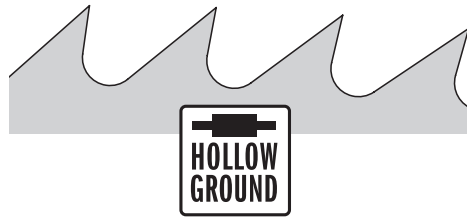

**MACHINES**



Blade diameter compatibility is contingent on machine type.

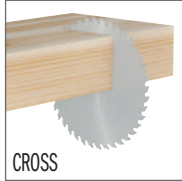

**APPLICATIONS**

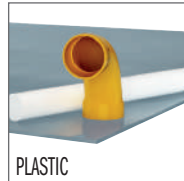

**MATERIALS**



**X10 (10-PC. BULK MASTERPACK)**

ORDER NO.	PACKAGING		D	T	B	K	P	$\alpha$	
			inches	mm	inches	inches	inches		
<b>P07140-X10</b>	10-pc. bulk masterpack	<b>30</b>	7-1/4	184	140	5/8 	0.071	0.063	5°



**P07120-X10 ITK<sup>PLUS</sup>**



**MULTI-MATERIALS**

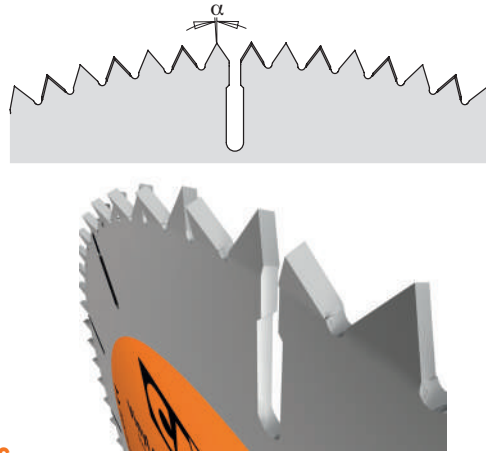

**X10 (10-PC. BULK MASTERPACK)**

**MACHINES**



**MATERIALS**

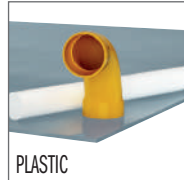

Blade diameter compatibility is contingent on machine type.

ORDER NO.	PACKAGING		D inches	mm	T	B inches		K inches	P inches	α
<b>P07120-X10</b>	10-pc. bulk masterpack	<b>30</b>	7-1/4	184	120	5/8		0.071	0.047	5°

Multi-Materials Carbide Wheel

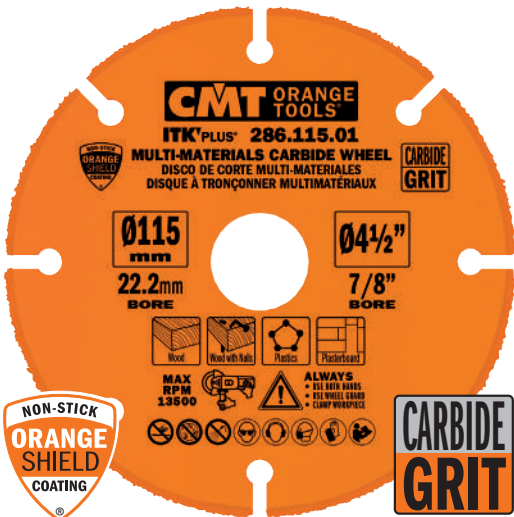

**286 ITK<sup>PLUS</sup>**



**MULTI-MATERIALS**

**SAFETY TIPS**

ALWAYS: Use both hands;  
Use wheel guard;  
Clamp workpiece.

ORDER NO.		D inches	B inches
<b>286.115.01</b>	<b>10</b>	4-1/2	7/8 (+3/8+5/8)
<b>286.125.01</b>	<b>10</b>	5	7/8 (+20mm+5/8)
<b>286.230.01</b>	<b>5</b>	9	7/8

**MACHINES**



**MATERIALS**

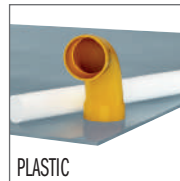

Blade diameter compatibility is contingent on machine type.

For specific details regarding suggested materials, please check blade label.



**286 ITK PLUS®**

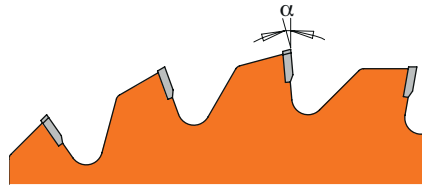

**MACHINES**



**MATERIALS**

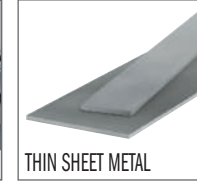

ORDER NO.	PACKAGING		D inches	mm	T	B inches	β	K inches	P inches	α
286.024.12	clamshell	5	12	305	24	1	TCG	0.126	0.098	-5° Neg.
286.024.14	clamshell	5	14	355	24	1	TCG	0.138	0.110	-5° Neg.

12" and 14" blades include 7/8" and 20mm reduction rings

Clearing grass, bushes, small trees



**298 ITK PLUS®**

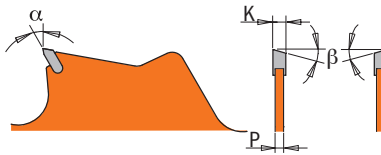

**MULTI-MATERIALS**



**SECURED TOOTH - MORE RESISTANT TO ACCIDENTAL CONTACT**

Teeth are welded deep inside blade body which significantly reduces breakage caused by accidental contact with terrain, rocks or stones, masonry work, metal parts, etc.; avoid all contact with these elements wherever possible.

**HEAVY DUTY PLATE - THIN, LIGHT AND STRONG**

Cut from the finest steel. Remarkably thin kerf and specifically designed perforations considerably reduce blade weight thereby reducing tool workload.

**SAFETY WARNING**

Circular saw blades are suitable for thinning brush and cutting small trees up to a diameter of 2 inches in thickness. Do not attempt to cut trees with larger diameters, since the blade may catch or jerk the clearing saw forward. This may cause damage to the blade or loss of control of the power tool and result in serious injury. Use a chain saw for such work. The operator shall ensure, while working, that no persons or animals come within 50 feet of the tool while in operation. Inspect the work area: remove stones, rocks, pieces of metal and other solid objects which could be thrown by the cutting attachment causing damage to objects or injury to those in close proximity. To reduce the risk of blade/teeth breakage, avoid all contact with terrain, rocks or stones, masonry work, metal parts, etc.



**MACHINES**



**MATERIALS**

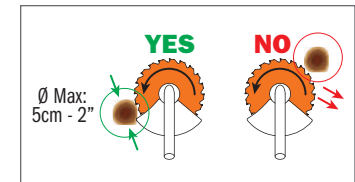
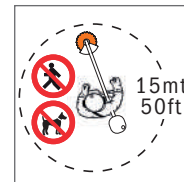

ORDER NO.	PACKAGING		D inches	T	B	RPM max	β	K inches	P inches	α
298.250.20	clamshell	10	10	20	1" (+20mm)	12.000	8° ATB	0.079	0.055	2°
298.250.40	clamshell	10	10	40	1" (+20mm)	12.000	8° ATB	0.079	0.055	2°



# Ripping

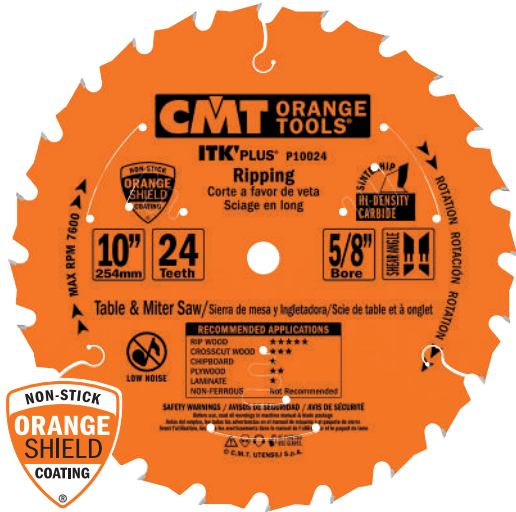

## P10024 ITK PLUS®



**WOOD**

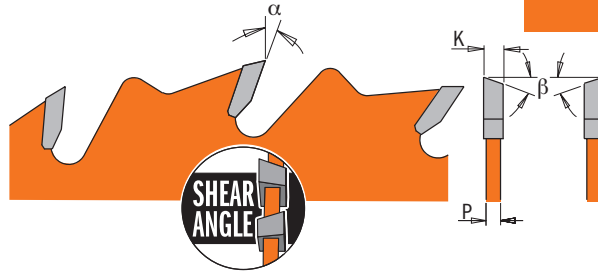

### MACHINES



Blade diameter compatibility is contingent on machine type.

### APPLICATIONS



### MATERIALS



ORDER NO.	PACKAGING		D		T	B	$\beta$	K	P	$\alpha$
			inches	mm		inches		inches	inches	
<b>P10024</b>	clamshell	<b>10</b>	10	254	24	5/8	10° ATB+Shear	0.094	0.063	20°



**P10042 - P10042W**  
**P12042 ITK PLUS®**



**WOOD**

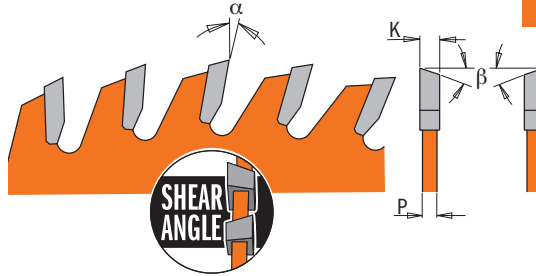

**MACHINES**



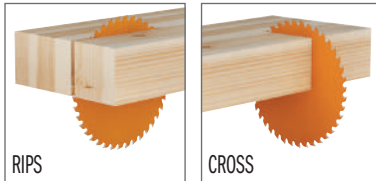

Blade diameter compatibility is contingent on machine type.

**APPLICATIONS**



**MATERIALS**



ORDER NO.	PACKAGING		inches	D	mm	T	B	β	K	P	α
<b>P10042</b>	clamshell	10	10	254	42	5/8	10° ATB+Shear	0.094	0.063	15°	
<b>P10042W</b>	clamshell	10	10-1/4	260	42	5/8 	10° ATB+Shear	0.094	0.063	15°	
<b>P12042</b>	clamshell	5	12	305	42	1	10° ATB+Shear	0.102	0.071	18°	

# Combination



**P10050 ITK PLUS®**



**WOOD**

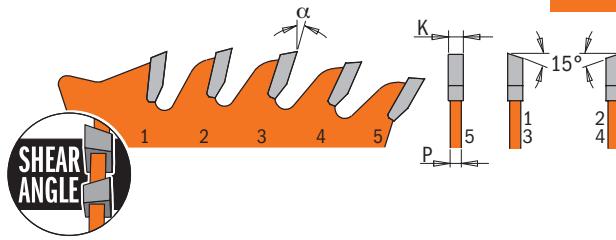

## MACHINES



Blade diameter compatibility is contingent on machine type.

## APPLICATIONS

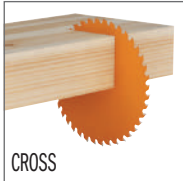

## MATERIALS



ORDER NO.	PACKAGING		D		T	B	$\beta$	K	P	$\alpha$
			inches	mm		inches		inches	inches	
<b>P10050</b>	clamshell	<b>10</b>	10	254	50	5/8	FLAT+4 ATB+Shear	0.094	0.063	15°



**P10060 - P12072**  
**ITK PLUS®**



**WOOD**

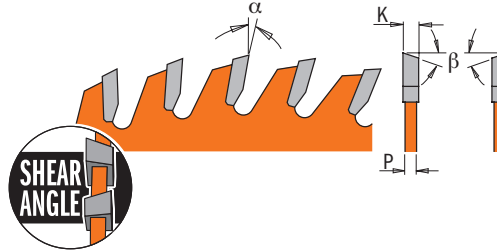

**MACHINES**



Blade diameter compatibility is contingent on machine type.

**APPLICATIONS**

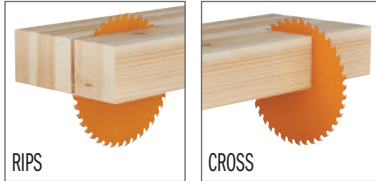

**MATERIALS**



ORDER NO.	PACKAGING		inches	D	mm	T	B	β	K	P	α
<b>P10060</b>	clamshell	<b>10</b>	10	254	60	5/8	10° ATB+Shear	0.094	0.063	15°	
<b>P12072</b>	clamshell	<b>5</b>	12	305	72	1	10° ATB+Shear	0.102	0.071	15°	



# Finish Sliding Compound



**P08060S - P10060S**  
**P12072S ITK PLUS®**



**WOOD**

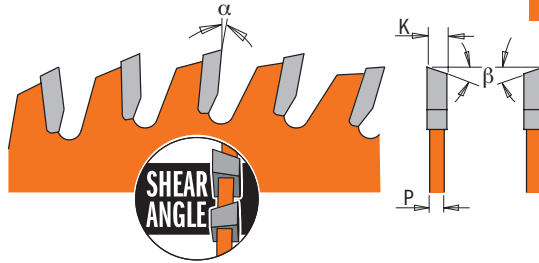

## MACHINES



Blade diameter compatibility is contingent on machine type.

## APPLICATIONS

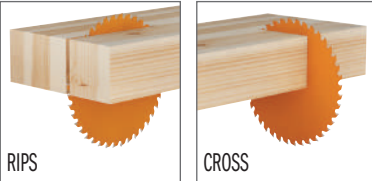

## MATERIALS



ORDER NO.	PACKAGING		inches	D mm	T	B inches	$\beta$	K inches	P inches	$\alpha$
<b>P08060S</b>	clamshell	10	8-1/2	216	60	5/8	10° ATB+Shear	0.067	0.039	7°
<b>P10060S</b>	clamshell	10	10	254	60	5/8	10° ATB+Shear	0.094	0.063	7°
<b>P12072S</b>	clamshell	5	12	305	72	1	10° ATB+Shear	0.102	0.071	5°



**P10060L - P12072L**

**ITK PLUS®**



**WOOD**

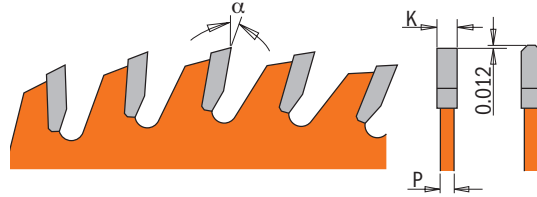

**MACHINES**



Blade diameter compatibility is contingent on machine type.

**APPLICATIONS**

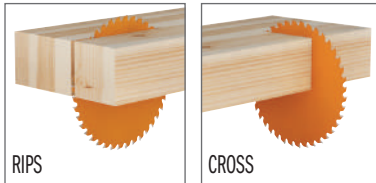

**MATERIALS**



ORDER NO.	PACKAGING		inches	D mm	T	B inches	$\beta$	K inches	P inches	$\alpha$
<b>P10060L</b>	clamshell	<b>10</b>	10	254	60	5/8	TCG	0.094	0.063	10°
<b>P12072L</b>	clamshell	<b>5</b>	12	305	72	1	TCG	0.102	0.071	10°

# Melamine & Ultra Finish



**P10080 - P12096**

**ITK PLUS®**



**WOOD**

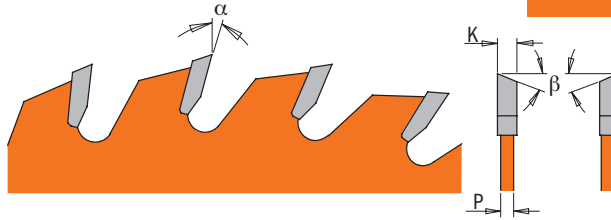

## MACHINES



Blade diameter compatibility is contingent on machine type.

## APPLICATIONS

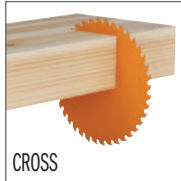
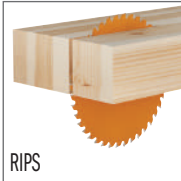

## MATERIALS

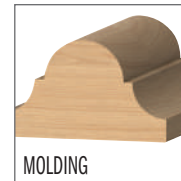

ORDER NO.	PACKAGING		inches	D	mm	T	B	β	K	P	α
P10080	clamshell	10	10	254	80	5/8	30° ATB+Shear	0.094	0.063	10°	
P12096	clamshell	5	12	305	96	1	30° ATB+Shear	0.102	0.071	10°	

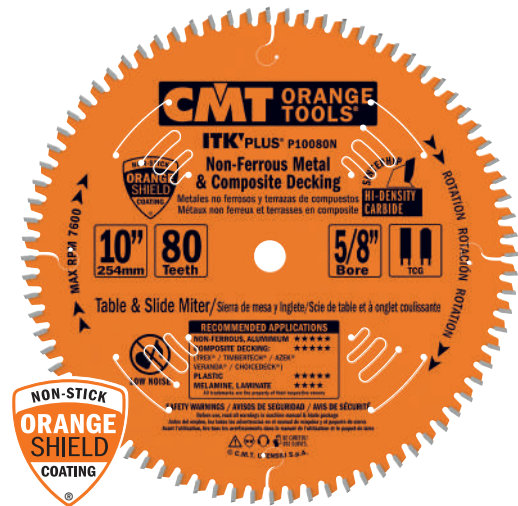

**P07056N - P10080N**  
**P12096N - 276**  
**ITK PLUS®**



**NON-FERROUS**

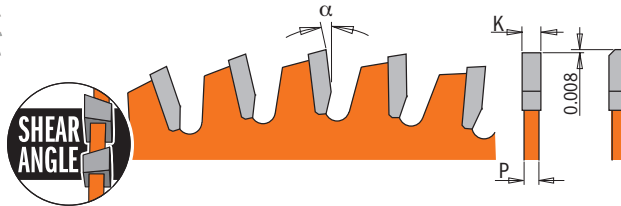

## MACHINES



Blade diameter compatibility is contingent on machine type.

## APPLICATIONS

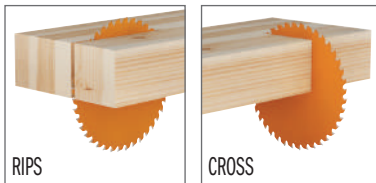

## MATERIALS

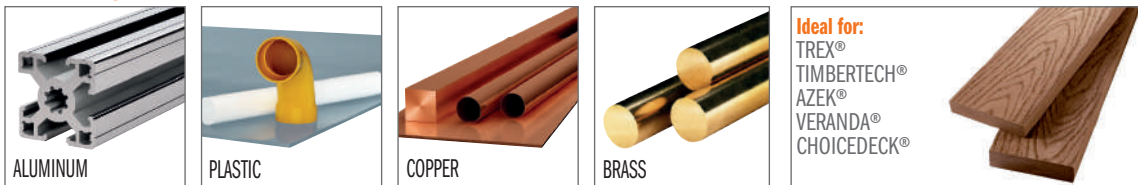

ORDER NO.	PACKAGING		inches	D	mm	T	B	PIN HOLE	$\beta$	K	P	$\alpha$
							inches			inches	inches	
<b>P07056N</b>	clamshell	10	7-1/4	184	56	5/8			TCG	0.087	0.063	-6° Neg.
<b>P10080N</b>	clamshell	10	10	254	80	5/8			TCG	0.094	0.063	-6° Neg.
<b>P12096N</b>	clamshell	5	12	305	96	1			TCG	0.102	0.071	-6° Neg.
<b>276.160.48H</b> ●	clamshell	10		160	48	20mm (+16)		2/6/32	TCG	0.071	0.047	-6° Neg.
<b>276.165.56H</b> ■	clamshell	10	6-1/2	165	56	20mm (+5/8)		2/6/32	TCG	0.071	0.047	-6° Neg.

- Ideal for FESTOOL®
- Ideal for Track Saws





# CMT CONTRACTOR TOOLS®

Designed for the professional contractor and remodeler, the **CMT CONTRACTOR TOOLS®** thin-kerf blade line guarantees great performance at a very appealing price. Ideal for any construction project involving wood or wood composite.



**HQ  
STEEL**

**HEAVY-DUTY LASER CUT PLATE**

Cut from the finest steel and hardened to 44 HRC, these thin, yet strong blades ensure longer life and exceptional cutting precision.

- ★★★★★ INDUSTRIAL CHROME®
- ★★★★★ INDUSTRIAL ORANGE SHIELD®
- ★★★★★ ITK XTREME
- ★★★★ ITK PLUS®
- ★★★ CMT CONTRACTOR TOOLS®

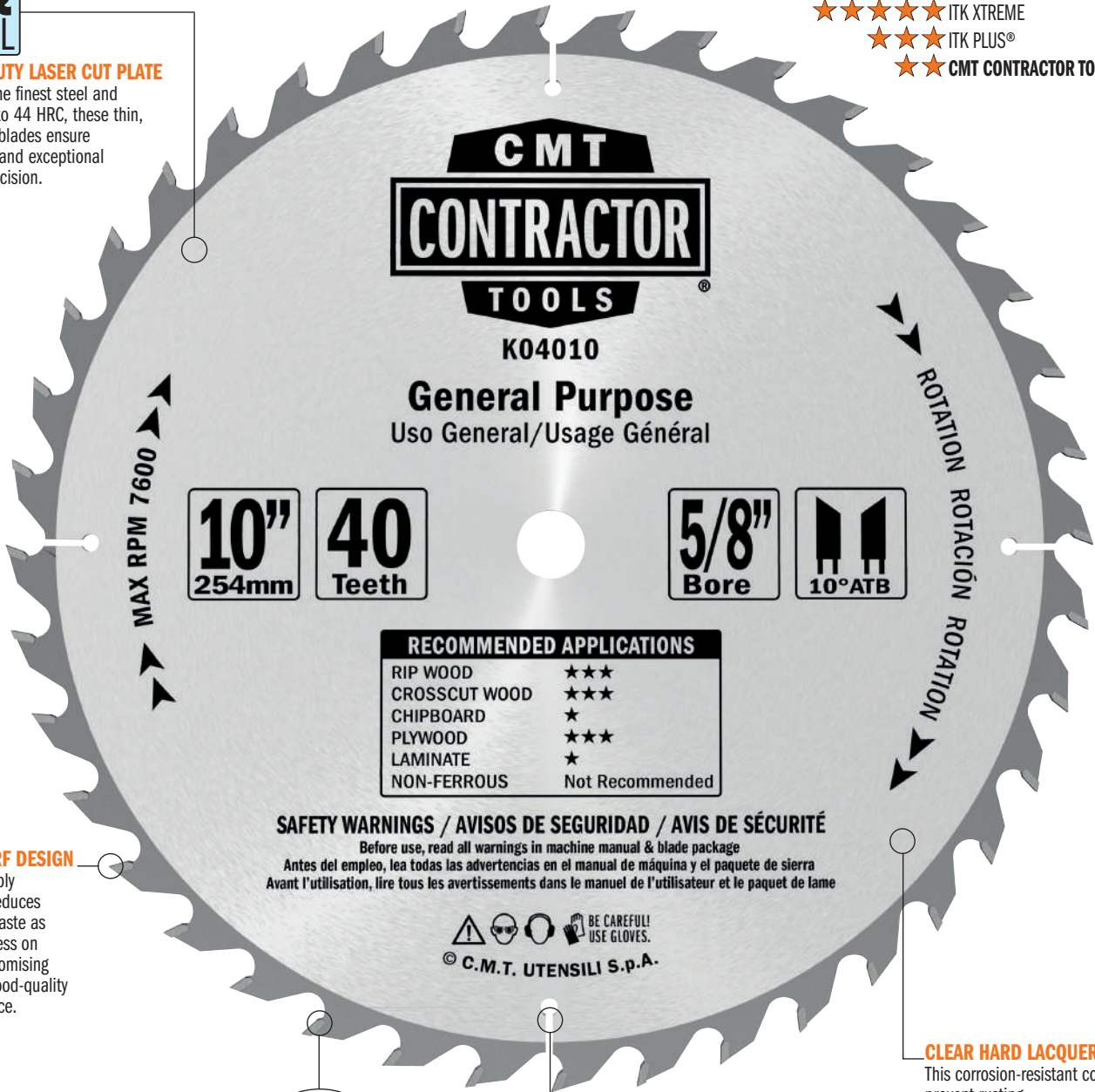

MAX RPM 7600

**10"**  
254mm

**40**  
Teeth

**5/8"**  
Bore

**10° ATB**

RECOMMENDED APPLICATIONS	
RIP WOOD	★★★
CROSSCUT WOOD	★★★
CHIPBOARD	★
PLYWOOD	★★★
LAMINATE	★
NON-FERROUS	Not Recommended

**SAFETY WARNINGS / AVISOS DE SEGURIDAD / AVIS DE SÉCURITÉ**  
 Before use, read all warnings in machine manual & blade package  
 Antes del empleo, lea todas las advertencias en el manual de máquina y el paquete de sierra  
 Avant l'utilisation, lire tous les avertissements dans le manuel de l'utilisateur et le paquet de lame

BE CAREFUL!  
USE GLOVES.  
© C.M.T. UTENSILI S.P.A.

**THIN-KERF DESIGN**  
A remarkably thin-kerf reduces material waste as well as stress on the saw promising reliable, good-quality performance.

**LONG LASTING CONSTRUCTION GRADE CARBIDE**  
The cutting teeth are made of specially formulated construction grade carbide extending cutting life and enhancing cutting performance.



**HEAT EXPANSION SLOTS**  
Engineered to allow blade expansion when heat build-up occurs from use, preventing blade warping.

**CLEAR HARD LACQUER COATING**  
This corrosion-resistant coating helps prevent rusting.

**FASTER CUT LONGER LIFE  
RESHARPENABLE**





## K02406 - K02407 - K02408



**WOOD**

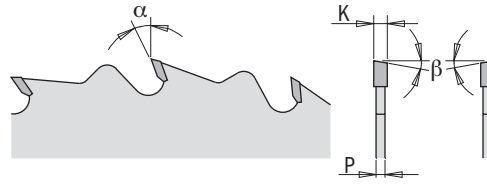

### MACHINES



Blade diameter compatibility is contingent on machine type.

### APPLICATIONS



### MATERIALS



**X10 (10-PC. BULK MASTERPACK)**

ORDER NO.	PACKAGING		inches	D	mm	T	B	β	K	P	α
K02406	clamshell	10	6-1/2	165	24	5/8	12° ATB	0.071	0.047	18°	
K02407	clamshell	10	7-1/4	184	24	5/8	10° ATB	0.071	0.047	20°	
K02408	clamshell	10	8 - 8-1/4	210	24	5/8	10° ATB	0.071	0.047	20°	

ORDER NO.	PACKAGING		inches	D	mm	T	B	β	K	P	α
K02406-X10	10-pc. bulk masterpack	30	6-1/2	165	24	5/8	12° ATB	0.071	0.047	18°	
K02407-X10	10-pc. bulk masterpack	10	7-1/4	184	24	5/8	10° ATB	0.071	0.047	20°	



**K02405 - K03606  
K04007 - K04008**



**WOOD**

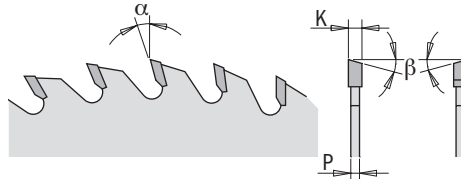

**MACHINES**



Blade diameter compatibility is contingent on machine type.

**APPLICATIONS**



**MATERIALS**



**X10 (10-PC. BULK MASTERPACK)**

ORDER NO.	PACKAGING		inches	D mm	T	B inches	$\beta$	K inches	P inches	$\alpha$
<b>K02405*</b>	clamshell	10	5-1/2	140	24	5/8	8° ATB	0.063	0.039	22°
<b>K03606</b>	clamshell	10	6-1/2	165	36	5/8	10° ATB	0.071	0.047	18°
<b>K04007</b>	clamshell	10	7-1/4	184	40	5/8	10° ATB	0.071	0.047	12°
<b>K04008</b>	clamshell	10	8 - 8-1/4	210	40	5/8	10° ATB	0.071	0.047	20°

\* Includes rings for 1/2" bore and 10mm bore

ORDER NO.	PACKAGING		inches	D mm	T	B inches	$\beta$	K inches	P inches	$\alpha$
<b>K04007-X10</b>	10-pc. bulk masterpack	10	7-1/4	184	40	5/8	10° ATB	0.071	0.047	12°





**K02403 - K03604  
K06007**



**WOOD**

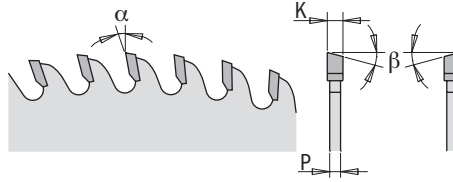

**MACHINES**



Blade diameter compatibility is contingent on machine type.

**APPLICATIONS**

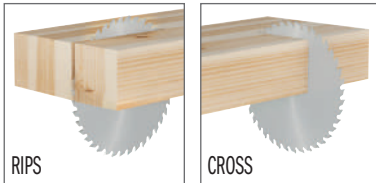

**MATERIALS**



ORDER NO.	PACKAGING		D	T	B	β	K	P	α	
			inches	mm	inches		inches	inches		
K02403	clamshell	10	3-3/8	86	24	15mm	5° ATB	0.043	0.028	12°
K03604*	clamshell	10	4-3/8	111	36	5/8	8° ATB	0.059	0.039	15°
K06007	clamshell	10	7-1/4	184	60	5/8	10° ATB	0.071	0.047	15°

\* Includes rings for 3/8" bore and 10mm bore



**K14007-X10**



**K20010**



**WOOD**

## MACHINES

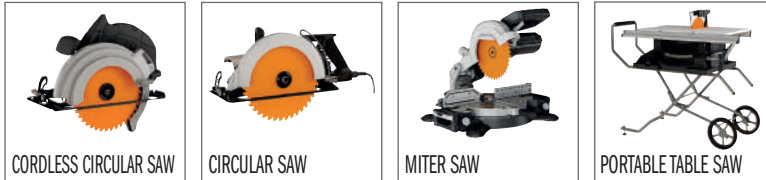

Blade diameter compatibility is contingent on machine type.

## APPLICATIONS

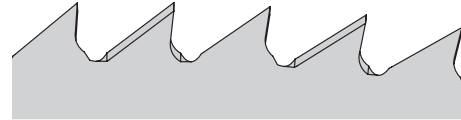

## MATERIALS



**X10 (10-PC. BULK MASTERPACK)**

ORDER NO.	PACKAGING		D	T	B	K	P	$\alpha$	
			inches	mm	inches	inches	inches		
<b>K20010</b>	clamshell	<b>10</b>	10	254	200	5/8	0.095	0.071	5°

ORDER NO.	PACKAGING		D	T	B	K	P	$\alpha$	
			inches	mm	inches	inches	inches		
<b>K14007-X10</b>	10-pc. bulk masterpack	<b>30</b>	7-1/4	184	140	5/8	0.079	0.047	5°



## K02410 - K02412



**WOOD**

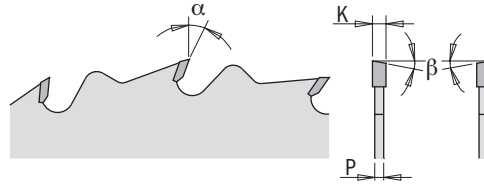

### MACHINES



Blade diameter compatibility is contingent on machine type.

### APPLICATIONS



### MATERIALS



ORDER NO.	PACKAGING		inches	D	mm	T	B	β	K	P	α
K02410	clamshell	10	10	254	24	5/8	10° ATB	0.094	0.063	22°	
K02412	clamshell	5	12	305	24	1	10° ATB	0.102	0.071	15°	



**K04010 - K04012 - K06014**

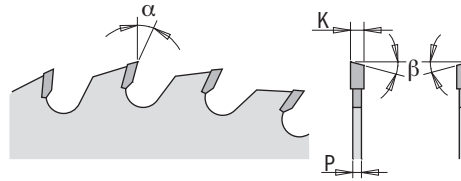

**MACHINES**



PORTABLE TABLE SAW

Blade diameter compatibility is contingent on machine type.

**APPLICATIONS**

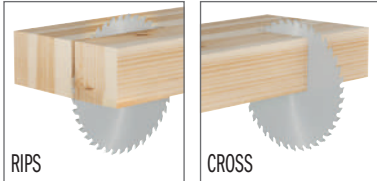

**MATERIALS**



ORDER NO.	PACKAGING		D		T	B	β	K	P	α
			inches	mm						
<b>K04010</b>	clamshell	<b>10</b>	10	254	40	5/8	10° ATB	0.094	0.063	20°
<b>K04012</b>	clamshell	<b>5</b>	12	305	40	1	10° ATB	0.102	0.071	15°
<b>K06014</b>	clamshell	<b>5</b>	14	355	60	1	10° ATB	0.126	0.087	15°





**K06010 - K06012**

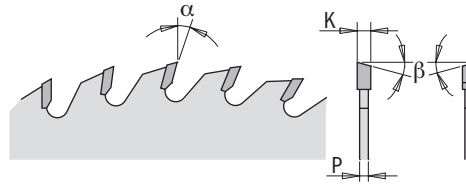

**MACHINES**



Blade diameter compatibility is contingent on machine type.

**APPLICATIONS**

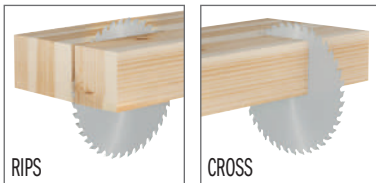

**MATERIALS**



ORDER NO.	PACKAGING		D		T	B	$\beta$	K	P	$\alpha$
			inches	mm		inches		inches	inches	
<b>K06010</b>	clamshell	<b>10</b>	10	254	60	5/8	10° ATB	0.094	0.063	15°
<b>K06012</b>	clamshell	<b>5</b>	12	305	60	1	10° ATB	0.102	0.071	15°



**K08010 - K08012**



**WOOD**

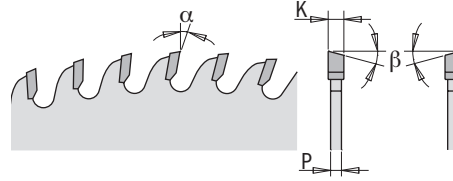

**MACHINES**



Blade diameter compatibility is contingent on machine type.

**APPLICATIONS**



**MATERIALS**



ORDER NO.	PACKAGING		inches	D	mm	T	B	β	K	P	α
K08010	clamshell	10	10	254	80	5/8	10° ATB	0.094	0.063	15°	
K08012	clamshell	5	12	305	80	1	10° ATB	0.102	0.071	15°	



## WHY TOOTH GEOMETRY IS IMPORTANT!

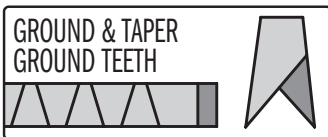

Easily cut construction wood, plywood, framing lumber and plastic.

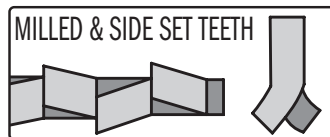

For quick cutting on hard/softwood, aluminum, plastic, ferrous and non-ferrous metal.

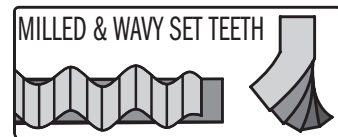

For fine, precise cuts in thin/thick metal, pipe, open and closed profiles.



**HIGH CARBON STEEL**  
For cuts on soft wood or plastic.



**BI-METAL WITH 8% COBALT**  
Provides superb results and guarantees long life when cutting metals, plastic and wood with nails.



**TUNGSTEN CARBIDE TIPPED**  
Ideal for construction materials: fibercement board, brick and porous concrete.





# QUALITY MATERIALS FOR MAXIMUM PRODUCTIVITY

Produced by following state-of-the-art processes, using high-tech machines and premium quality raw materials, these sabre saw blades have been specifically designed to ensure maximum lifetime and performance in all materials.

## THE RIGHT BLADE FOR THE JOB!

Use our quick reference chart and pictograms to help you choose the best blade for your application.



### NON-STICK ORANGE SHIELD® COATING

Keeps the blade running cool, reduces pitch build up and protects against corrosion. Ideal for all types of wood including wet lumber.

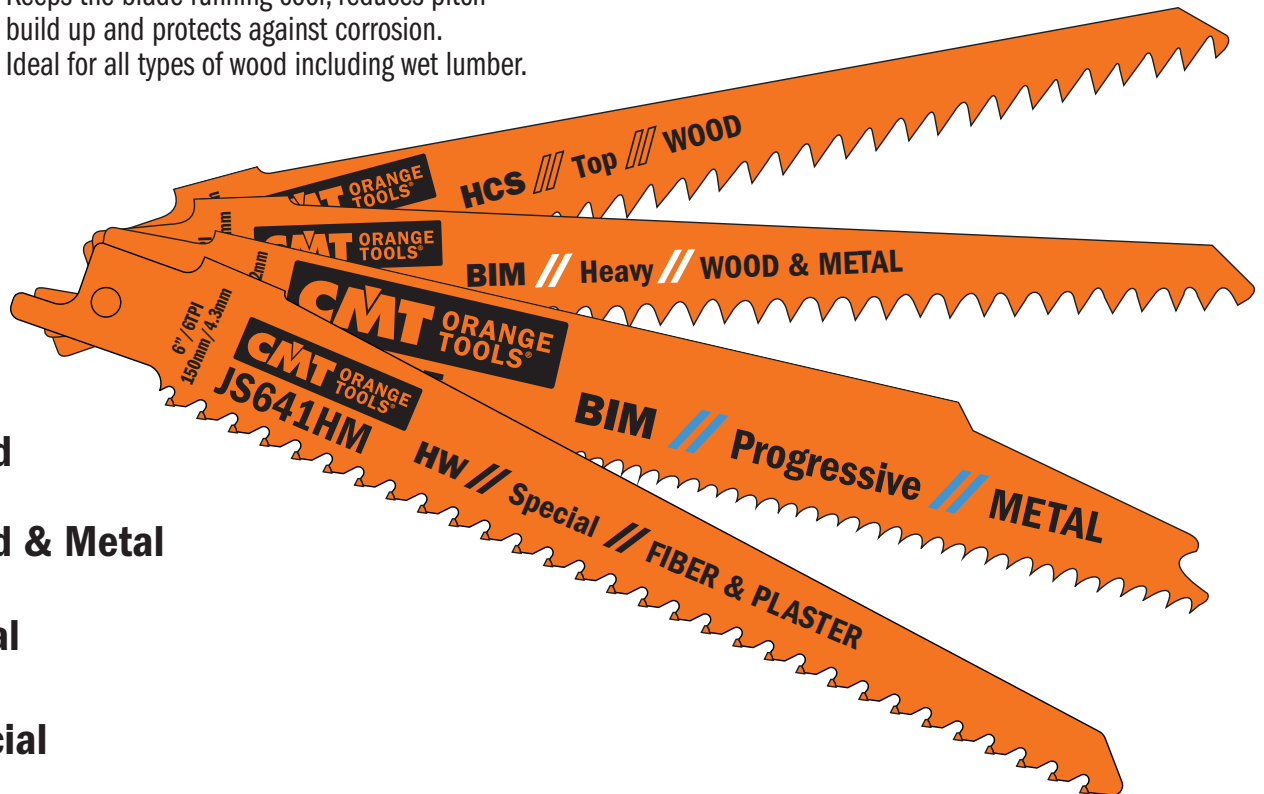

Wood



Wood & Metal



Metal



Special

### BLADE LINE DESCRIPTIONS

Different blade lines help you choose the right blade for the task.

- BASIC:** Cost effective
- FLEXIBLE:** Breakproof, long lifetime
- PROGRESSIVE:** Fast cutting through thin and thick material
- TOP:** Fast and efficient
- HEAVY:** Sturdy and precise

### 12,7MM (1/2") UNIVERSAL SHANK

Fits: AEG®, BLACK & DECKER®, BOSCH®, DEWALT®, FEIN®, FLEX®, HILTI®, MAKITA®, METABO®, MILWAUKEE®, PORTER CABLE®, RIDGID®, ROTHENBERGER®, RYOBI®, SKIL®.

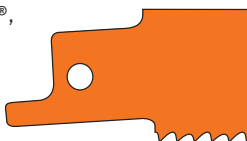

### BLADE SHAPE & THICKNESS

Sabre Saw Blades vary in shape and thickness. These two characteristics are adjusted according to the demands of the application as well as the required flexibility. Rigorous applications such as cutting tube and pipe require thick robust blades, while less demanding applications require narrower blades.

Three Main Blade Categories:



Universal blades are for general use. Their even width guarantees good cutting stability and excellent control. This enables straight edge cutting through many different materials.

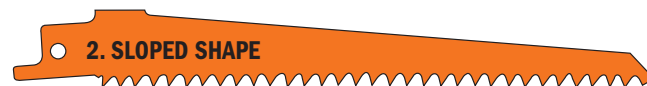

Sloped blades are commonly used for cutting wood and for demolition applications. Their narrow tip allows for plunge and curve cutting. This shape is rarely used for metal, since the tip does not have the strength required for this application.

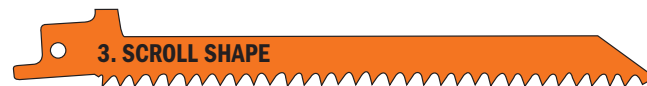









Scroll blades are especially used for curve cutting. The narrower the blade, the smaller the radius it can cut.











# Reciprocating Saw Blades Application Chart



SERIES	MATERIAL	MATERIAL THICKNESS  inches	LINE	L INCHES	FINE STRAIGHT	COARSE STRAIGHT	FINE CURVE	FINE ANGLE CUT	FLUSH CUT	THIN & THICK	DEMOLITION	TPI	PAGE	
														
<b>WOOD</b>	<b>Coarse wood (free of nails)</b>	<4	Basic	6		JS617K	JS617K					3	92	
	<b>Pruning green wood</b>	<7	Basic	9		JS1111K						3	92	
	Coolant: dry	<7-1/2	Top	9-1/2		JS1531L						5	92	
	MAX RPM 2500	<10	Basic	12		JS1617K						3	92	
	<b>Construction wood</b>	<4	Top	6	JS644D		JS644D					6	92	
	Coolant: dry	<6	Progressive	8	JS2345X					JS2345X		6-10	92	
	MAX RPM 2500	<6	Pallet	8	JS725VFR			JS725VFR		JS725VFR	JS725VFR	8-12	94	
	<b>Boards</b>	<2-3/8	Top	6	JS644D		JS644D					6	92	
	Coolant: dry	<2-3/8	Progressive	8	JS2345X					JS2345X		6-10	92	
	MAX RPM 2500	<2-3/8	Pallet	8	JS725VFR			JS725VFR		JS725VFR		8-12	94	
	<b>Wooden wall cutout</b>	<4	Top	6	JS644D		JS644D					6	92	
	Coolant: dry	<6	Progressive	8	JS2345X					JS2345X		6-10	92	
	MAX RPM 2500	<6	Pallet	8	JS725VFR			JS725VFR		JS725VFR	JS725VFR	8-12	94	
	<b>Plastic</b>	<7-1/2	Top	9-1/2		JS1531L						5	92	
	Coolant: water MAX RPM 500	<4	Top	6	JS644D		JS644D					6	92	
		<6	Progressive	8	JS2345X					JS2345X		6-10	92	
	<b>WOOD &amp; METAL</b>		<4	Flexible	6	JS922HF							10	95
			<4	Flexible	6	JS922VF							10-14	95
		<4	Heavy	6	JS641HM	JS611DF	JS711DF					6	99,93	
		<4	Heavy	6	JS610VF			JS610VF			JS610VF	5-8	93	
		<4	Heavy	6	JS956XHM			JS956XHM			JS956XHM	5-8	96	
		<6	Progressive	8		JS3456XF				JS3456XF		6-12	94	
<b>Wood with nails/metal</b>		<6	Pallet	8	JS725VFR			JS725VFR		JS725VFR	JS725VFR	8-12	94	
Coolant: dry		<7	Flexible	9	JS1122HF				JS1122HF			10	95	
MAX RPM 2500		<7	Flexible	9	JS1122VF				JS1122HF			10-14	95	
		<7	Heavy	9		JS1111DF						6	93	
		<7	Heavy	9		JS1110VF		JS1110VF			JS1110VF	5-8	94	
		<7	Heavy	9		JS1156XHM		JS1156XHM			JS1156XHM	5-8	96	
		<7	Progressive	9		JS5678XF				JS5678XF		6-12	94	
		<10	Flexible	12	JS1222VF				JS1222VF			10-14	95	
		<10	Heavy	12		JS1210VF		JS1210VF			JS1210VF	5-8	94	
		<10	Heavy	12		JS1411DF						6	93	
<b>Pallet</b>		<4	Flexible	6	JS922HF	JS641HM						10	95,99	
Coolant: dry		<6	Pallet	8	JS725VFR			JS725VFR		JS725VFR	JS725VFR	8-12	94	
MAX RPM 2500		<7	Flexible	9	JS1122HF				JS1122HF			10	95	
		<4	Heavy	6		JS611DF	JS711DF					6	93	
		<4	Heavy	6		JS610VF		JS610VF			JS610VF	5-8	93	
		<4	Heavy	6		JS956XHM		JS956XHM			JS956XHM	5-8	96	
<b>Wood, chipboard</b>		<6	Progressive	8		JS3456XF				JS3456XF		6-12	94	
Coolant: dry		<6	Pallet	8	JS725VFR			JS725VFR		JS725VFR	JS725VFR	8-12	94	
MAX RPM 2500		<7	Heavy	9		JS1111DF						6	93	
		<7	Heavy	9		JS1110VF		JS1110VF			JS1110VF	5-8	95	
		<7	Heavy	9		JS1156XHM		JS1156XHM			JS1156XHM	5-8	96	
		<7	Progressive	9		JS5678XF				JS5678XF		6-12	94	
		<10	Heavy	12		JS1210VF		JS1210VF			JS1210VF	5-8	94	
		<10	Heavy	12		JS1411DF						6	93	
<b>Sheet metals</b>		1/8-3/8	Flexible	6	JS922VF							10-14	95	
Coolant: cutting oil		1/8-3/8	Flexible	9	JS1122VF				JS1122HF			10-14	95	
MAX RPM 500-2000		1/8-3/8	Flexible	12	JS1222VF				JS1222VF			10-14	95	
	1/8-23/32	Progressive	8		JS3456XF				JS3456XF		6-12	94		
	<7	Progressive	9		JS5678XF				JS5678XF		6-12	94		
<b>Pipes, profiles</b>	<4	Flexible	6	JS922VF							10-14	95		
Coolant: cutting oil	<6	Progressive	8		JS3456XF				JS3456XF		6-12	94		
MAX RPM 1500	<7	Flexible	9	JS1122VF				JS1122HF			10-14	95		
	<7	Progressive	9		JS5678XF				JS5678XF		6-12	94		
	<10	Flexible	12	JS1222VF				JS1222VF			10-14	95		
<b>Plastic, pipes, profiles</b>	<4	Heavy	6		JS611DF	JS711DF					6	93		
Coolant: water	<6	Progressive	8		JS3456XF				JS3456XF		6-12	94		
MAX RPM 500	<7	Heavy	9		JS1111DF						6	93		
	<7	Progressive	9		JS5678XF				JS5678XF		6-12	94		
	<10	Heavy	12		JS1411DF						6	93		
<b>Glass fiber-reinforced plastic/epoxy</b>	<2	Heavy	6		JS611DF	JS711DF					6	93		
Coolant: water	<2-3/8	Heavy	12		JS1411DF						6	93		
MAX RPM 500	<2-3/8	Heavy	6		JS610VF		JS610VF			JS610VF	5-8	93		
	<4	Heavy	6		JS956XHM		JS956XHM			JS956XHM	5-8	96		

# Reciprocating Saw Blades Application Chart



SERIES	MATERIAL	MATERIAL THICKNESS  inches	LINE	L INCHES	FINE STRAIGHT	COARSE STRAIGHT	FINE CURVE	FINE ANGLE CUT	FLUSH CUT	THIN & THICK	DEMOLITION	TPI	PAGE	
														
<b>WOOD &amp; METAL</b>	Glass fiber-reinforced plastic/epoxy Coolant: water MAX RPM 500	<2-3/8	Heavy	9		JS1111DF						6	93	
		<2-3/8	Heavy	9		JS1110VF		JS1110VF			JS1110VF	5-8	94	
		<7	Heavy	9		JS1156XHM		JS1156XHM			JS1156XHM	5-8	96	
		<4	Flexible	6	JS922VF	JS641HM							10-14	95,99
		<6	Progressive	8		JS3456XF					JS3456XF		6-12	94
		<7	Flexible	9	JS1122VF					JS1122HF			10-14	95
		<7	Progressive	9		JS5678XF					JS5678XF		6-12	94
		<10	Flexible	12	JS1222VF					JS1222VF			10-14	95
	<10	Heavy	12		JS1210VF		JS1210VF			JS1210VF	5-8	94		
<b>METAL</b>	Sheet, perforated metals, (thin & thick) Coolant: dry MAX RPM 500-2000	1/32-1/8	Flexible	6	JS922AF							24	99	
		1/32-1/8	Flexible	9	JS1122AF				JS1122AF				24	99
		3/64-5/16	Progressive	6	JS123XF						JS123XF		8-14	97
		1/16-5/32	Flexible	6	JS922EF								18	98
		1/16-5/32	Flexible	9	JS1122EF					JS1122EF			18	98
		5/64-3/8	Heavy	6	JS925VF							JS925VF	10-14	97
		5/64-3/8	Heavy	8	JS1025VF							JS1025VF	10-14	97
		5/64-3/8	Heavy	9	JS1125VF							JS1125VF	10-14	97
		5/64-3/8	Heavy	12	JS1125VF							JS1225VF	10-14	97,98
		1/8-5/16	Flexible	6	JS922BF								14	98
		1/8-5/16	Flexible	9	JS1122BF					JS1122BF			14	98
		5/32-1/2	Heavy	6		JS920CF		JS920CF				JS920CF	9	96
		5/32-1/2	Heavy	6		JS955CHM		JS955CHM				JS955CHM	9	96
		5/32-1/2	Heavy	9		JS1120CF		JS1120CF				JS1120CF	9	97
	5/32-1/2	Heavy	9		JS1155CHM		JS1155CHM				JS1155CHM	9	96	
	Pipes, profiles, thin-walled (open & closed) Coolant: dry MAX RPM 500-2000	<4	Flexible	6	JS922AF								24	99
		<4	Flexible	6	JS922EF								18	98
		<4	Progressive	6	JS123XF						JS123XF		8-14	97
		<4	Heavy	6	JS925VF							JS925VF	10-14	97
		<6	Heavy	8	JS1025VF							JS1025VF	10-14	97
		<7	Flexible	9	JS1122AF					JS1122AF			24	99
		<7	Flexible	9	JS1122EF					JS1122EF			18	98
		<7	Heavy	9	JS1125VF							JS1125VF	10-14	97
		<10	Heavy	12	JS1225VF							JS1225VF	10-14	98
		Pipes, profiles, thick-walled (open & closed) Coolant: dry MAX RPM 500-2000	<4	Flexible	6	JS922BF								14
	<4		Progressive	6	JS123XF						JS123XF		8-14	97
	<4		Heavy	6	JS925VF							JS925VF	10-14	97
	<4		Heavy	6		JS920CF		JS920CF				JS920CF	9	96
	5/32-1/2		Heavy	6		JS955CHM		JS955CHM				JS955CHM	9	96
	<6		Heavy	8	JS1025VF							JS1025VF	10-14	97
	<7		Flexible	9	JS1122BF					JS1122BF			14	98
	<7		Heavy	9	JS1125VF							JS1125VF	10-14	97
<7	Heavy		9		JS1120CF		JS1120CF				JS1120CF	9	97	
5/32-1/2	Heavy		9		JS1155CHM		JS1155CHM				JS1155CHM	9	96	
Pipes, profiles (solid) Coolant: cutting oil MAX RPM 500-2000	<10	Heavy	12	JS1225VF							JS1225VF	10-14	98	
	<4	Progressive	6	JS123XF						JS123XF		8-14	97	
	<4	Flexible	6	JS922BF								14	98	
	<4	Heavy	6		JS920CF		JS920CF				JS920CF	9	96	
	5/32-1/2	Heavy	6		JS955CHM		JS955CHM				JS955CHM	9	96	
	<7	Flexible	9	JS1122BF						JS1122BF		14	98	
<b>SPECIAL</b>	Plasterboard	<4	Heavy	6	JS641HM	JS611DF	JS711DF					6	99,93	
	Fiber cement panels	<7	Special	9		JS1141HM		JS1141HM					3	99
		<8-1/2	Special	12		JS1243HM		JS1243HM					2	100
		<10	Special	12		JS1241HM		JS1241HM					3	99
		<14	Special	18		JS2243HM		JS2243HM					2	100
	Porous concrete, red brick	<7	Special	9		JS1141HM		JS1141HM					3	99
		<8-1/2	Special	12		JS1243HM		JS1243HM					2	100
		<10	Special	12		JS1241HM		JS1241HM					3	99
	<14	Special	18		JS2243HM		JS2243HM					2	100	
Ice, frozen, meat, bone	<10	Special	12		JS1211K							3	100	

**TIP:** Using a lubricant can extend blade lifetime up to 500%.

# Reciprocating Saw Blades



## JS617K



ORDER NO.	SKIN PACK	L	I	H	K	TPI	
Universal shank	Quantity	inches	inches	inches	inches	Teeth Per Inch	
JS617K-5	5	6	5	3/4	0.049	3	10



Cuts coarse wood, free of nails (<4"), pruning green wood (diameter <4"), excellent for curved and plunge cutting.

## JS1111K

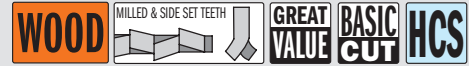

ORDER NO.	SKIN PACK	L	I	H	K	TPI	
Universal shank	Quantity	inches	inches	inches	inches	Teeth Per Inch	
JS1111K-5	5	9	8	3/4	0.049	3	10



Coarse wood, free of nails (<6-7/8"), firewood (diameter <6-7/8").

## JS1617K



ORDER NO.	SKIN PACK	L	I	H	K	TPI	
Universal shank	Quantity	inches	inches	inches	inches	Teeth Per Inch	
JS1617K-5	5	12	11	3/4	0.049	3	10



Coarse wood, free of nails (<10"), pruning green wood (diameter <10").

## JS644D

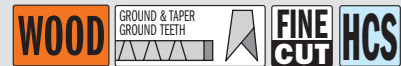

ORDER NO.	SKIN PACK	L	I	H	K	TPI	
Universal shank	Quantity	inches	inches	inches	inches	Teeth Per Inch	
JS644D-5	5	6	5	3/4	0.049	6	10



Cuts construction wood (<4"), wooden wall panels (<4"), chipboard, MDF (1/4"~2-3/8"), plywood, plastic (<4"). Special for plunge cutting.

## JS1531L

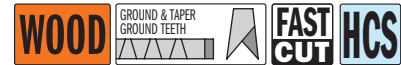

ORDER NO.	SKIN PACK	L	I	H	K	TPI	
Universal shank	Quantity	inches	inches	inches	inches	Teeth Per Inch	
JS1531L-5	5	9-1/2	8-5/8	3/4	0.059	5	10



Coarse wood, free of nails (<7-1/2"), pruning green wood (diameter <7-1/2"), firewood (diameter <7-1/2").

## JS2345X



ORDER NO.	SKIN PACK	L	I	H	K	TPI	
Universal shank	Quantity	inches	inches	inches	inches	Teeth Per Inch	
JS2345X-5	5	8	7-1/8	3/4	0.049	6-10	10



Cuts construction wood (<5-7/8"), chipboard, MDF (1/4"~2-3/8"), plywood, plastic (<6"), wooden wall (<5-7/8"). Effortless fine cutting.

# Reciprocating Saw Blades



## JS611DF

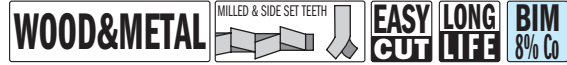

ORDER NO.	SKIN PACK Quantity	L inches	I inches	H inches	K inches	TPI Teeth Per Inch	
JS611DF-5	5	6	5-1/8	3/4	0.049	6	10

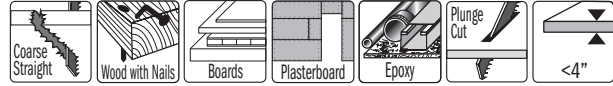

Cuts wood with nails/embedded metal (<4"), plastic profiles (<4"), fiberglass and epoxy (<2"), wood and metal window frames. Special for plunge cutting.

## JS711DF

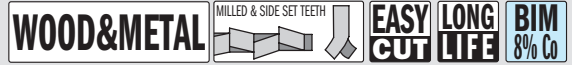

ORDER NO.	SKIN PACK Quantity	L inches	I inches	H inches	K inches	TPI Teeth Per Inch	
JS711DF-5	5	6	5-1/8	1/2	0.049	6	10

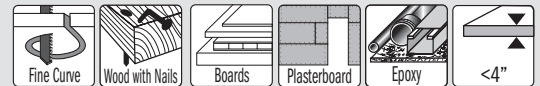

Cuts wood with nails/embedded metal (<4"), fiberglass and epoxy (<2"). Excellent for curved cuts.

## JS1111DF

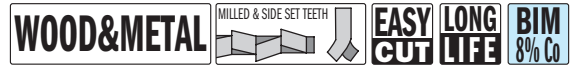

ORDER NO.	SKIN PACK Quantity	L inches	I inches	H inches	K inches	TPI Teeth Per Inch	
JS1111DF-5	5	9	8	3/4	0.049	6	10
JS1111DF-20	20	9	8	3/4	0.049	6	5

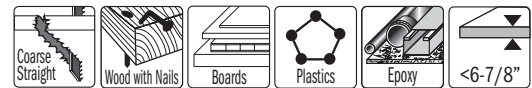

For cutting wood with nails/embedded metal, chipboard (<6-7/8"), plastic profiles (<6-7/8"), fiberglass and epoxy (<2").

## JS1411DF

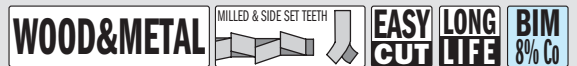

ORDER NO.	SKIN PACK Quantity	L inches	I inches	H inches	K inches	TPI Teeth Per Inch	
JS1411DF-5	5	12	11	3/4	0.049	6	10

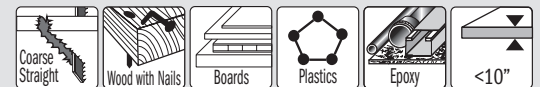

Cuts wood with nails/embedded metal, chipboard (<10"), fiberglass and epoxy (<2-3/8").

## JS610VF



ORDER NO.	SKIN PACK Quantity	L inches	I inches	H inches	K inches	TPI Teeth Per Inch	
JS610VF-5	5	6	5-1/8	7/8	0.063	5-8	10

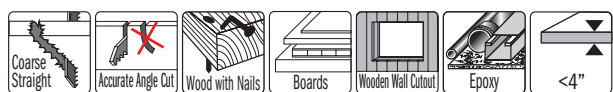

Cuts wood with nails/metal, wood, chipboard (<4"), fiberglass and epoxy (<4"), wood and metal wall cut-outs, (<4"). Excellent for rescue/demolition work.



# Reciprocating Saw Blades



## JS1110VF

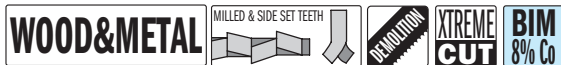

ORDER NO.	SKIN PACK Quantity	L inches	I inches	H inches	K inches	TPI Teeth Per Inch	
JS1110VF-5	5	9	8	7/8	0.063	5-8	10
JS1110VF-20	20	9	8	7/8	0.063	5-8	5

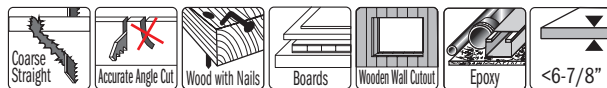

For cutting wood with nails/embedded metal, chipboard (<6-7/8"), fiberglass and epoxy, wood and metal wall cut-outs (<6-7/8"). For rescue and demolition work.

## JS1210VF

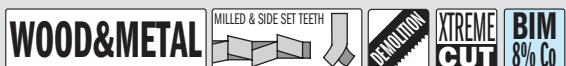

ORDER NO.	SKIN PACK Quantity	L inches	I inches	H inches	K inches	TPI Teeth Per Inch	
JS1210VF-5	5	12	11	7/8	0.063	5-8	10



Cuts wood with nails/embedded metal, wood, chipboard (<10"), fiberglass and epoxy (<10"), wood and metal wall cut-outs (<10").

## JS3456XF

new



ORDER NO.	SKIN PACK Quantity	L inches	I inches	H inches	K inches	TPI Teeth Per Inch	
JS3456XF-5	5	8	7-1/8	3/4	0.049	6-12	10
JS3456XF-20	20	8	7-1/8	3/4	0.049	6-12	5

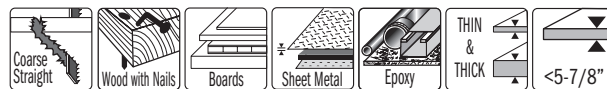

For cutting wood with nails/embedded metal (<5-7/8"), sheet metal, pipe and aluminum profiles from (1/8"~23/32") in thickness, fiberglass and epoxy (<5-7/8").

## JS5678XF



ORDER NO.	SKIN PACK Quantity	L inches	I inches	H inches	K inches	TPI Teeth Per Inch	
JS5678XF-5	5	9	8	1	0.049	6-12	10
JS5678XF-20	20	9	8	1	0.049	6-12	5

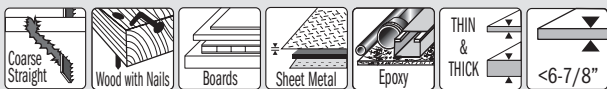

For cutting wood with nails or metal, chipboard (<6-7/8"), sheet metal, aluminum profiles (1/8"~23/32"), glass fiber-reinforced plastic/epoxy (<6-7/8").

## JS725VFR



ORDER NO.	SKIN PACK Quantity	L inches	I inches	H inches	K inches	TPI Teeth Per Inch	
JS725VFR-5	5	8	7-1/8	3/4	0.050	8-12	10
JS725VFR-20	20	8	7-1/8	3/4	0.050	8-12	5



Special saw blade for pallet repair. Cutting depth <5-7/8". Optimized for reduced vibration.

# Reciprocating Saw Blades



## JS922HF

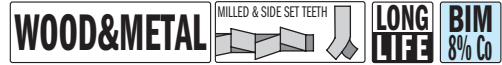

ORDER NO.	SKIN PACK	L	I	H	K	TPI	
Universal shank	Quantity	inches	inches	inches	inches	Teeth Per Inch	
JS922HF-5	5	6	5-1/8	3/4	0.035	10	10

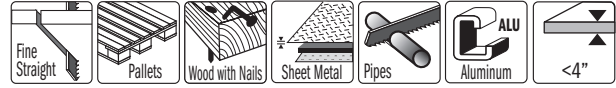

For pallet repair, wood with nails/embedded metal (<4"), sheet metal, pipe, aluminum profiles (1/8"~1/2").

## JS1122HF

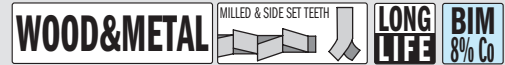

ORDER NO.	SKIN PACK	L	I	H	K	TPI	
Universal shank	Quantity	inches	inches	inches	inches	Teeth Per Inch	
JS1122HF-5	5	9	8	3/4	0.035	10	10
JS1122HF-20	20	9	8	3/4	0.035	10	5

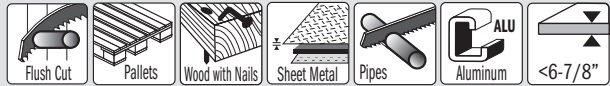

For pallet repair, wood with nails/embedded metal (<6-7/8"), sheet metal, pipe, aluminum profiles (1/8"~1/2"). Flexible flush cutting.

## JS922VF

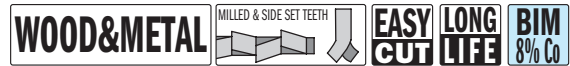

ORDER NO.	SKIN PACK	L	I	H	K	TPI	
Universal shank	Quantity	inches	inches	inches	inches	Teeth Per Inch	
JS922VF-5	5	6	5-1/8	3/4	0.035	10-14	10

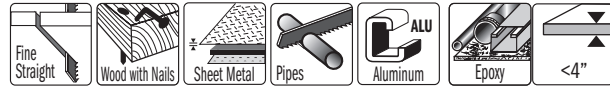

Cuts wood with nails/embedded metal (<4"), sheet metal, pipe and aluminum profiles (1/8"~3/8"), fiberglass and epoxy (<4").

## JS1122VF

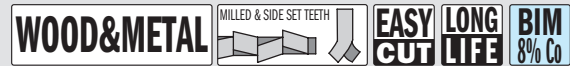

ORDER NO.	SKIN PACK	L	I	H	K	TPI	
Universal shank	Quantity	inches	inches	inches	inches	Teeth Per Inch	
JS1122VF-5	5	9	8	3/4	0.035	10-14	10



Cuts wood with nails/embedded metal (<6-7/8"), sheet metal, aluminum profiles (1/8"~3/8"), fiberglass and epoxy (<6-7/8"). Flexible flush cutting.

## JS1222VF

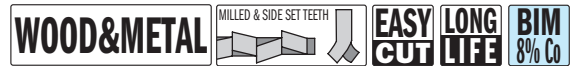

ORDER NO.	SKIN PACK	L	I	H	K	TPI	
Universal shank	Quantity	inches	inches	inches	inches	Teeth Per Inch	
JS1222VF-5	5	12	11	3/4	0.035	10-14	10

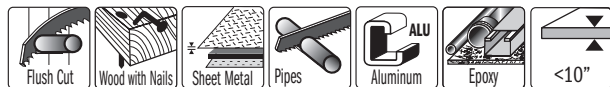

Cuts wood with nails/embedded metal (<10"), sheet metal, aluminum profiles (1/8"~3/8"), fiberglass and epoxy (<10"). Flexible flush cutting.

# Reciprocating Saw Blades



## JS956XHM



ORDER NO.	SKIN PACK	L	I	H	K	TPI	
Universal shank	Quantity	inches	inches	inches	inches	Teeth Per Inch	
JS956XHM-3	3	6	5-1/8	15/16	0.047	6-8	10

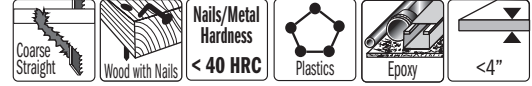

For cutting wood with nails or metal (nails/metal hardness up to 40 HRC), repairing pallets, plasterboard, plastics, glass fiber-reinforced plastic/epoxy, fiber cement (<4"). For rescue and demolition work.

## JS1156XHM

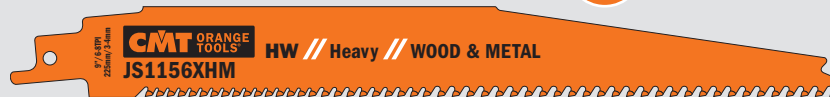

ORDER NO.	SKIN PACK	L	I	H	K	TPI	
Universal shank	Quantity	inches	inches	inches	inches	Teeth Per Inch	
JS1156XHM-3	3	9	8	15/16	0.047	6-8	10

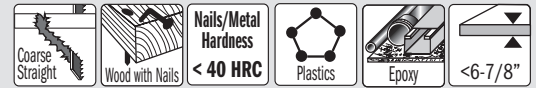

For cutting wood with nails or metal (nails/metal hardness up to 40 HRC), repairing pallets, plasterboard, plastics, glass fiber-reinforced plastic/epoxy, fiber cement (<6-7/8"). For rescue and demolition work.

## JS955CHM



ORDER NO.	SKIN PACK	L	I	H	K	TPI	
Universal shank	Quantity	inches	inches	inches	inches	Teeth Per Inch	
JS955CHM-3	3	6	5-1/8	15/16	0.047	8	10

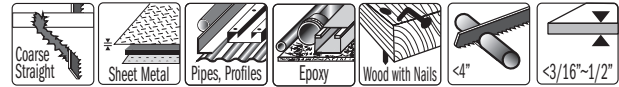

For cutting thick sheet metal (3/16"~1/2"), pipes & profiles (<4"), plastics, glass fiber-reinforced plastic/epoxy, fiber cement (<4"), wood with nails or metal.

## JS1155CHM

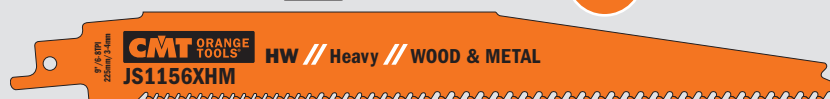

ORDER NO.	SKIN PACK	L	I	H	K	TPI	
Universal shank	Quantity	inches	inches	inches	inches	Teeth Per Inch	
JS1155CHM-3	3	9	8	15/16	0.047	8	10



For cutting thick sheet metal (3/16"~1/2"), pipes & profiles (<6-7/8"), plastics, glass fiber-reinforced plastic/epoxy, fiber cement (<6-7/8"), wood with nails or metal.

## JS920CF



ORDER NO.	SKIN PACK	L	I	H	K	TPI	
Universal shank	Quantity	inches	inches	inches	inches	Teeth Per Inch	
JS920CF-5	5	6	5-1/8	7/8	0.063	9	10

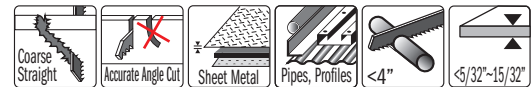

Cuts thick sheet metal (5/32"~15/32"), thick-walled pipe and profiles (<4"). Ideal for pipe cutting, for rescue/demolition work. Powerful coarse cutting.

# Reciprocating Saw Blades



## JS1120CF



ORDER NO.	SKIN PACK Quantity	L inches	I inches	H inches	K inches	TPI Teeth Per Inch	
JS1120CF-5	5	9	8	7/8	0.063	9	10
JS1120CF-20	20	9	8	7/8	0.063	9	5

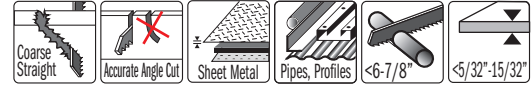

For cutting thick sheet metal (5/32"~15/32"), thick-walled pipe and profiles (<6-7/8"). Ideal for pipe cutters, for rescue/demolition work. Powerful coarse cutting.

## JS123XF



ORDER NO.	SKIN PACK Quantity	L inches	I inches	H inches	K inches	TPI Teeth Per Inch	
JS123XF-5	5	6	5-1/8	3/4	0.035	8-14	10

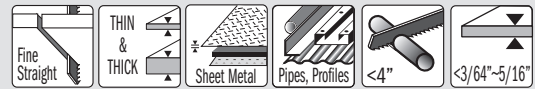

Cuts thin sheet metal (3/64"~5/16") pipes and profiles (diameter <4").

## JS925VF



ORDER NO.	SKIN PACK Quantity	L inches	I inches	H inches	K inches	TPI Teeth Per Inch	
JS925VF-5	5	6	5	3/4	0.049	10-14	10



Cuts medium-thick to thick sheet metal (5/64"~25/64"), thin and thick-walled pipe and profiles (<4"). Ideal for demolition work in metal. Fine effortless cutting.

## JS1025VF

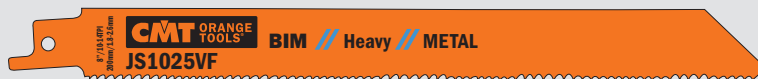

ORDER NO.	SKIN PACK Quantity	L inches	I inches	H inches	K inches	TPI Teeth Per Inch	
JS1025VF-5	5	8	7-1/8	3/4	0.049	10-14	10



Cuts medium-thick to thick sheet metal (5/64"~25/64"), thin and thick-walled pipe and profiles (<5-7/8"). Ideal for demolition work on metal. Fine effortless cutting.

## JS1125VF



ORDER NO.	SKIN PACK Quantity	L inches	I inches	H inches	K inches	TPI Teeth Per Inch	
JS1125VF-5	5	9	8	3/4	0.049	10-14	10



Cuts medium-thick to thick sheet metal (5/64"~25/64"), thin and thick-walled pipe and profiles (<6-7/8"). Ideal for demolition work on metal. Fine effortless cutting.



# Reciprocating Saw Blades



## JS1225VF



ORDER NO.	SKIN PACK Quantity	L inches	I inches	H inches	K inches	TPI Teeth Per Inch	
JS1225VF-5	5	12	11	3/4	0.049	10-14	10



Cuts medium-thick to thick sheet metal (5/64"~25/64"), thin and thick-walled pipe and profiles (<10"). Ideal for demolition work in metal. Fine effortless cutting.

## JS922BF



ORDER NO.	SKIN PACK Quantity	L inches	I inches	H inches	K inches	TPI Teeth Per Inch	
JS922BF-5	5	6	5-1/8	3/4	0.035	14	10
JS922BF-20	20	6	5-1/8	3/4	0.035	14	5



Cuts thin sheet metal (1/8"~5/16"), thin pipe and profiles (diameter <4"). Fine effortless cutting.

## JS1122BF



ORDER NO.	SKIN PACK Quantity	L inches	I inches	H inches	K inches	TPI Teeth Per Inch	
JS1122BF-5	5	9	8	3/4	0.035	14	10
JS1122BF-20	20	9	8	3/4	0.035	14	5



Cuts thin sheet metal (1/8"~5/16"), thin pipe and profiles (diameter <6-7/8"). Fine effortless cutting. Flexible flush cuts.

## JS922EF



ORDER NO.	SKIN PACK Quantity	L inches	I inches	H inches	K inches	TPI Teeth Per Inch	
JS922EF-5	5	6	5-1/8	3/4	0.035	18	10
JS922EF-20	20	6	5-1/8	3/4	0.035	18	5



Cuts thin sheet metal (1/16"~5/32"), pipe and profiles (diameter <4").

## JS1122EF



ORDER NO.	SKIN PACK Quantity	L inches	I inches	H inches	K inches	TPI Teeth Per Inch	
JS1122EF-5	5	9	8	3/4	0.035	18	10
JS1122EF-20	20	9	8	3/4	0.035	18	5

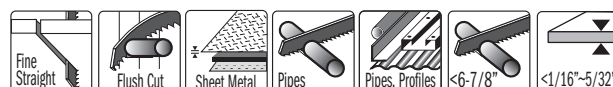

Cuts thin sheet metal (1/16"~5/32"), pipe and profiles (diameter <6-7/8"). Flexible flush cuts.

# Reciprocating Saw Blades



## JS922AF



ORDER NO.	SKIN PACK Quantity	L inches	I inches	H inches	K inches	TPI Teeth Per Inch	
JS922AF-5	5	6	5-1/8	3/4	0.035	24	10



Cuts thin sheet metal (1/32"~1/8"), fine pipe and profiles (diameter <4"). Effortless fine cuts.

## JS1122AF



ORDER NO.	SKIN PACK Quantity	L inches	I inches	H inches	K inches	TPI Teeth Per Inch	
JS1122AF-5	5	9	8	3/4	0.035	24	10



Cuts thin sheet metal (1/32"~1/8"), fine pipe and profiles (diameter <6-7/8"). Effortless fine cuts.

## JS641HM CARBIDE TOOTH



ORDER NO.	SKIN PACK Quantity	L inches	I inches	H inches	K inches	TPI Teeth Per Inch	
JS641HM-2	2	6	5-1/8	3/4	0.047	6	25

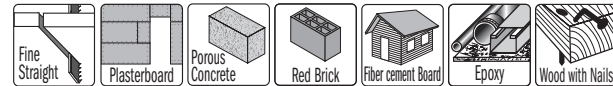

Cuts porous concrete, red brick, fiber cement, plasterboard, fiber-reinforced plastic and epoxy (<4"), wood & nails, ETERNIT®, MDF.

## JS1141HM CARBIDE TOOTH

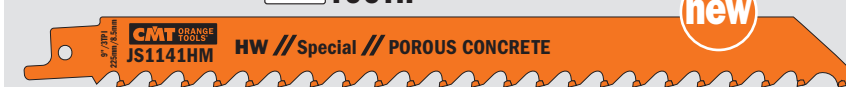

ORDER NO.	SKIN PACK Quantity	L inches	I inches	H inches	K inches	TPI Teeth Per Inch	
JS1141HM-2	2	9	8	7/8	0.047	3	25

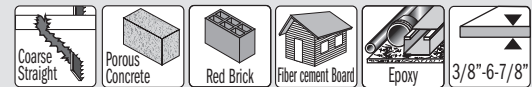

For cutting porous concrete, red brick, fiber cement (3/8"-6-7/8"), glass fiber-reinforced plastic/epoxy (<4"). Fast Cut.

## JS1241HM CARBIDE TOOTH



ORDER NO.	SKIN PACK Quantity	L inches	I inches	H inches	K inches	TPI Teeth Per Inch	
JS1241HM-2	2	12	11	7/8	0.059	3	25

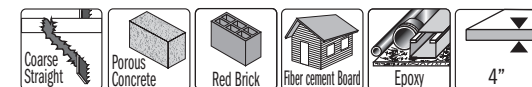

For cutting porous concrete, red brick, fiber cement (3/8"-10"), glass fiber-reinforced plastic/epoxy (<4"). Fast Cut.

# Reciprocating Saw Blades



## JS1243HM



**CARBIDE TOOTH**

**SPECIAL LONG LIFE FAST CUT CARBIDE TIPPED**

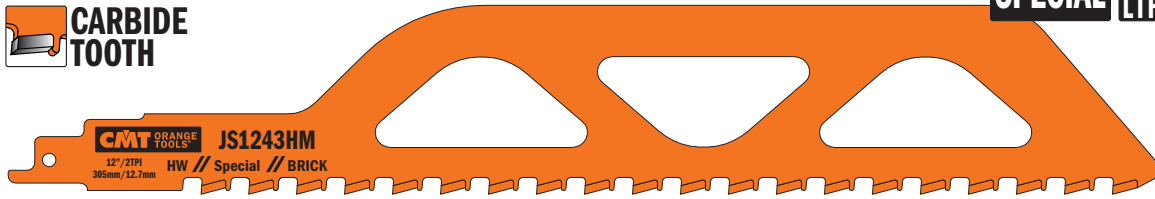

ORDER NO.	SKIN PACK	L	I	H	K	TPI	
Universal shank	Quantity	inches	inches	inches	inches	Teeth Per Inch	
<b>JS1243HM</b>	1	12	10	2	0.059	2	<b>25</b>

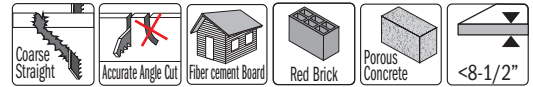

Cuts medium-sized brick up to 8-1/2" in thickness.

## JS2243HM



**CARBIDE TOOTH**

**SPECIAL LONG LIFE FAST CUT CARBIDE TIPPED**

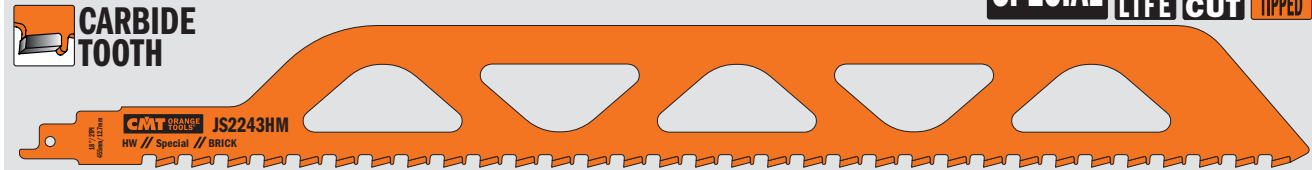

ORDER NO.	SKIN PACK	L	I	H	K	TPI	
Universal shank	Quantity	inches	inches	inches	inches	Teeth Per Inch	
<b>JS2243HM</b>	1	18	16	2	0.049	2	<b>25</b>

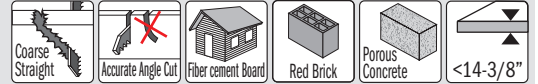

Cuts large brick up to 14-3/8" in thickness.

## JS1211K

**new**

**SPECIAL FAST CUT INOX**



ORDER NO.	SKIN PACK	L	I	H	K	TPI	
Universal shank	Quantity	inches	inches	inches	inches	Teeth Per Inch	
<b>JS1211K-5</b>	5	12	10-7/8	3/4	0.047	3	<b>10</b>

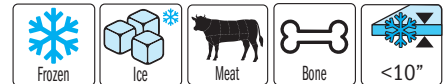

Ideal for sectioning and cutting meat, bone, frozen products and ice up to 10" in thickness.

## 25-piece Reciprocating Saw Blade Set

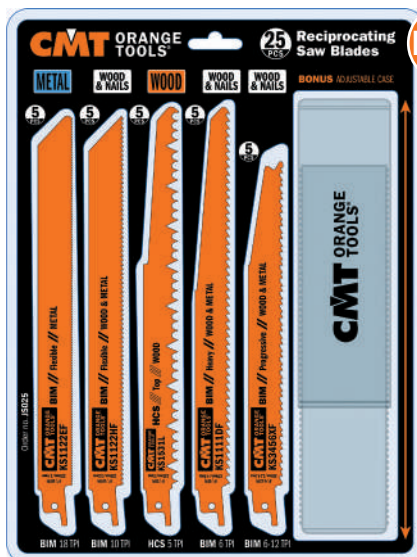

**new**

## JS025

<b>5 PCS</b>	<b>KS1122EF</b>	<b>METAL</b>	TPI 18 1.4mm	Fine Straight	Sheet Metal	Flush cut	Pipes, profiles	<175mm <1/8"-3/32"	<b>LONG LIFE</b>	
<b>5 PCS</b>	<b>KS1122HF</b>	<b>WOOD &amp; NAILS</b>	TPI 10 2.5mm	Wood with nails	Sheet Metal	Flush cut	Pallets	Pipes	<175mm <1/8"	<b>LONG LIFE</b>
<b>5 PCS</b>	<b>KS1531L</b>	<b>WOOD</b>	TPI 5 5mm	Coarse Straight	Nail-free coarse wood	Pruning		<190mm <1/2"	<b>FAST CUT</b>	
<b>5 PCS</b>	<b>KS1111DF</b>	<b>WOOD &amp; NAILS</b>	TPI 6 4.3mm	Wood with nails	Boards	PVC Plastic	Epoxy	<175mm <1/8"	<b>EASY CUT</b>	<b>LONG LIFE</b>
<b>5 PCS</b>	<b>KS3456XF</b>	<b>WOOD &amp; NAILS</b>	TPI 6-12 2.1-4.3mm	Wood with nails	Boards	Sheet Metal	Epoxy	THIN & THICK	<150mm <1/4"	<b>LONG LIFE</b>

Minimum 10 pieces or multiple



# QUALITY MATERIALS FOR OUTSTANDING PERFORMANCE

State-of-the-art processes and high-tech machinery are behind all of our jig saw blades. Composed of three different materials, they're specifically designed to make precise cuts on soft & hardwood, plywood, OSB, laminates, plastics, HPL, multiplex panels, metals, ferrous and non-ferrous materials, aluminum, fiberglass and stainless steel. And the best part, they're built to last!

## Nothing is more important than geometry!

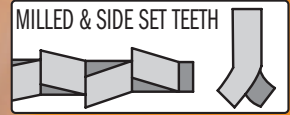

### MILLED & SIDE SET TEETH

Jig saw blades featuring this kind of geometry produce a quick rough cut into soft/hardwood, aluminum, plastic and non-ferrous metals.



### MILLED & WAVY SET TEETH

Suitable for fine straight cuts into plywood, soft steel, aluminum, non-ferrous metals and plastic.



### GROUND & SIDE SET TEETH

Best for quick cuts in wood.

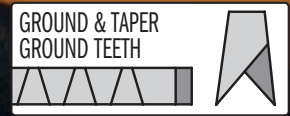

### GROUND & TAPER GROUND TEETH

This geometric attribute creates fine, clean and precise cuts in wood and plastic.

**HCS** **HIGH CARBON STEEL**  
Great for cutting wood, fiberboard and plastic.

**BIM** **BI-METAL WITH 8% COBALT**  
Premium bi-metal with 8% Cobalt provides superb results and guarantees long life when cutting metal, non-ferrous, plastic and wood with nails.

**HSS** **HIGH SPEED STEEL**  
For cutting harder materials, such as metals, aluminum and non-ferrous metals.

**CARBIDE TIPPED** **TUNGSTEN CARBIDE TIPPED**  
For cutting fiber cement board, brick, porous concrete, plasterboard, MDF, fiberglass and ETERNIT®.

## THE RIGHT BLADE FOR THE BEST RESULTS!

Quick reference charts and pictograms help you choose the right blade for your application.

/// Wood

/// Wood & Metal

/// Metal

/// Special

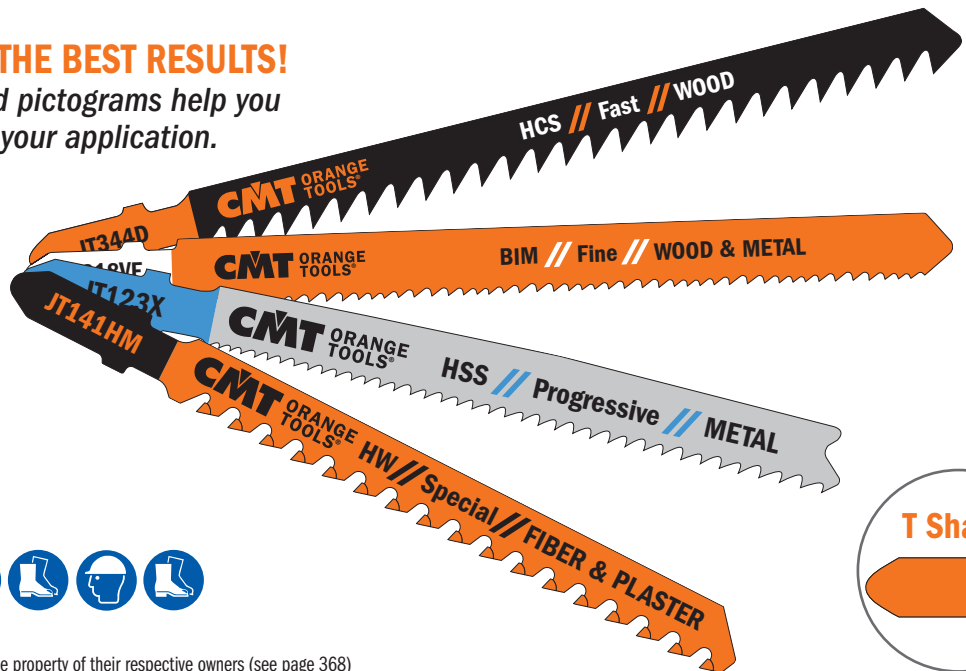



SERIES	MATERIAL	THICKNESS	LINE	FINE STRAIGHT	COARSE STRAIGHT	FINE CURVE	COARSE CURVE	PAGE	
		 inches							
<b>WOOD</b>	Softwood	1,5-15	Fine			JT101A0		104	
		2-15	Basic			JT119B0		103	
		3-65	Fine, Splinter-Free	JT234X					105
		3-30	Fine	JT101B					105
		3-30	Fine, Splinter-Free	JT101BR					104
		4-60	Basic			JT111C			103
		5-60	Fast			JT144D		JT244D - JT244DDC	103
		5-100	Fast			JT344D			104
		7-55	Fine	JT101D					105
		7-65	Fine	JT301CD - JT318VF					105
	Hardwood	1,5-15	Fine				JT101A0		104
		3-30	Fine	JT101B					104
		3-30	Fine, Splinter-Free	JT101BR					104
		3-65	Fine, Splinter-Free	JT234X					105
		5-60	Fast			JT144D		JT244D - JT244DDC	103
		5-100	Fast			JT344D			104
		7-55	Fine	JT101D					105
		7-65	Fine	JT301CD - JT318VF					105
	OSB	2-15	Basic				JT119B0		103
		3-30	Fine	JT101B					105
		4-60	Basic			JT111C			103
		5-60	Fast			JT144D		JT244D - JT244DDC	103
		7-55	Fine	JT101D - JT318VF					105
	Plywood	1,5-15	Fine				JT101A0		104
		2-15	Basic				JT119B0		103
		3-30	Fine	JT101B					104
		3-30	Fine, Splinter-Free	JT101BR					104
		3-65	Fine, Splinter-Free	JT234X - JT318VF					105
		4-60	Basic			JT111C			103
		5-60	Fast			JT144D		JT244D - JT244DDC	103
		5-100	Fast			JT344D			104
	7-55	Fine	JT101D - JT318VF					105	
	Construction Wood	<30	Fine	JT101B					104
		3-65	Fine, Splinter-Free	JT234X					105
		<100	Fast			JT344D			104
<135		Fast			JT144D			103	
Chipboard	2-15	Basic				JT119B0		103	
	3-30	Fine	JT101B			JT101A0		104	
	3-65	Fine, Splinter-Free	JT234X - JT318VF					105	
	4-60	Basic			JT111C			103	
	5-60	Fast			JT144D		JT244D - JT244DDC	103	
Laminated panels Kitchen Tops Worktops	1,5-15	Fine				JT101A0		104	
	1,5-15	Fine, Long Life	JT101BIF					105	
	3-30	Fine	JT101B					104	
	3-30	Fine, Splinter-Free	JT101BR					104	
	3-65	Fine, Splinter-Free	JT234X					105	
Sheet metals	1-3	Basic	JT118A			JT218A		106	
	1,5-10	Fast, Long Life	JT123X - JT318VF					106, 105	
	2,5-6	Basic	JT118B					106	
	1,5-10	Fast	JT123X - JT318VF					106, 105	
Aluminum, non-ferrous	<30	Fast	JT127D					106	
	1,5-10	Fast	JT123X - JT318VF					106, 105	
Pipes	<30	Fast	JT123X - JT318VF					106, 105	
Inox Sheets	1,5-3	Fast	JT123X - JT318VF					106, 105	
Sandwich Material	<120	Fast, Flexible	JT718BF					106	
PLASTIC	GRP (Fiberglass)	<30	Fast	JT127D				106	
	Plastic (PP, PE, PVC, PA, PS)	<30	Fine	JT101D				105	
		<30	Fast	JT123X				106	
7-65		Fine	JT301CD - JT318VF				105		
SPECIAL	Plasterboard	5-50	Special		JT141HM			107	
		5-80	Special		JT341HM			107	
	GRP (Fiberglass)	<80	Special		JT341HM			107	
	Fiber cement boards	5-50	Special		JT141HM			107	
		5-80	Special		JT341HM			107	
	Carton, Leather, Rubber	<100	Special	JT313AW				107	
	Soft Tile, Cast Iron	5-10	Special	JT150RF				107	

# Jig Saw Blades

## JT119B0



ORDER NO. T-Shank	SKIN PACK Quantity	I inches	L inches	TPI Teeth Per Inch	
JT119B0-5	5	2	3	12	100

Curve cuts on softwood (5/64"~19/32"), plywood, OSB.

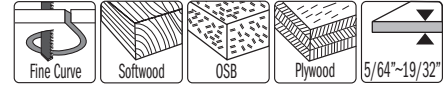

## JT111C



ORDER NO. T-Shank	SKIN PACK Quantity	I inches	L inches	TPI Teeth Per Inch	
JT111C-5	5	3	4	8	100

Fast coarse cuts on softwood (5/32"~2-3/8"), plywood, OSB.

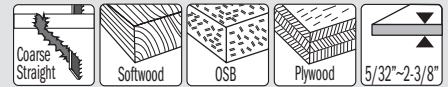
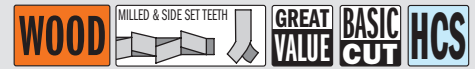

## JT144D



ORDER NO. T-Shank	SKIN PACK Quantity	I inches	L inches	TPI Teeth Per Inch	
JT144D-5	5	3	4	6	100
JT144D-25	25	3	4	6	10
JT144D-100	100	3	4	6	4

Very fast cuts, straight and coarse, on hard/softwood (7/32"~2-3/8"), plywood, OSB. Plunge cutting.

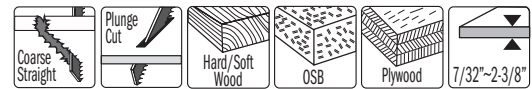

## JT244D



ORDER NO. T-Shank	SKIN PACK Quantity	I inches	L inches	TPI Teeth Per Inch	
JT244D-5	5	3	4	6	100

Fast, curve, coarse cut on soft and hardwood (7/32"~2-3/8"), plywood, OSB. Plunge cutting

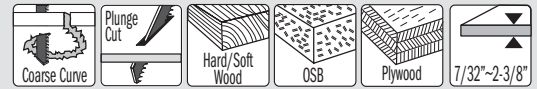

## JT244DDC



ORDER NO. T-Shank	SKIN PACK Quantity	I inches	L inches	TPI Teeth Per Inch	
JT244DDC-5	5	3	4	6	100

Fast, curve, coarse cut on soft and hardwood (7/32"~2-3/8"), plywood, OSB. Plunge cutting. Special "DUO" (double) cuts for fast curve cutting.

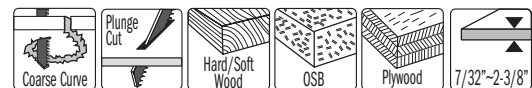

# Jig Saw Blades

## JT344D



ORDER NO. T-Shank	SKIN PACK Quantity	I inches	L inches	TPI Teeth Per Inch	
JT344D-5	5	4-1/2	5-1/2	6	100

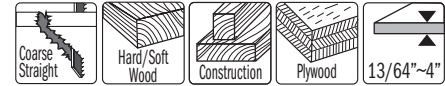

Very fast cuts, straight and coarse on thick construction timber, hard/softwood (13/64"~4"), plywood, OSB.

## JT744D



ORDER NO. T-Shank	SKIN PACK Quantity	I inches	L inches	TPI Teeth Per Inch	
JT744D-3	3	6-7/64	7-3/32	6	20



Very fast cuts, straight and coarse on thick construction timber, hard/softwood (13/64"~5-5/16") and sandwich material.

## JT101A0

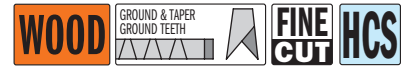

ORDER NO. T-Shank	SKIN PACK Quantity	I inches	L inches	TPI Teeth Per Inch	
JT101A0-5	5	2	3	20	100

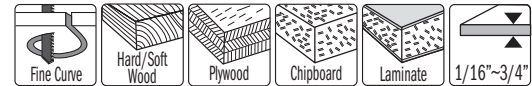

Curved cuts, fine finishing on both sides of surface on hard/softwood, plywood, chipboard, MDF, double sided laminates (1/16"~3/4").

## JT101B

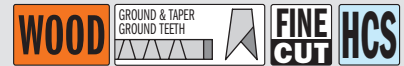

ORDER NO. T-Shank	SKIN PACK Quantity	I inches	L inches	TPI Teeth Per Inch	
JT101B-5	5	3	4	10	100
JT101B-25	25	3	4	10	10

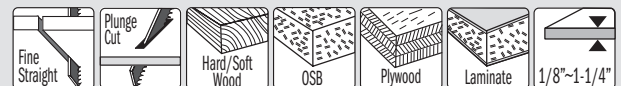

Fine straight cuts with fine finishing on hard/softwood, plywood, OSB and plastics (1/8"~1-1/4"). Plunge cutting.

## JT101BR

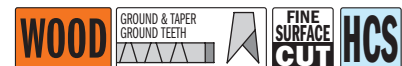

ORDER NO. T-Shank	SKIN PACK Quantity	I inches	L inches	TPI Teeth Per Inch	
JT101BR-5	5	3	4	10	100
JT101BR-25	25	3	4	10	10

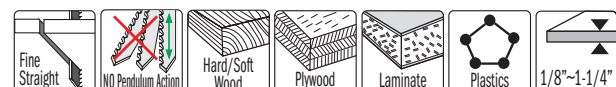

Straight cuts, fine finishing on upper side, hard/softwood, plywood, OSB, laminated panels, plastics (1/8"~1-1/4"). Reverse tooth.

## JT101D

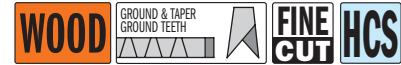

ORDER NO. T-Shank	SKIN PACK Quantity	I inches	L inches	TPI Teeth Per Inch	
JT101D-5	5	3	4	6	100

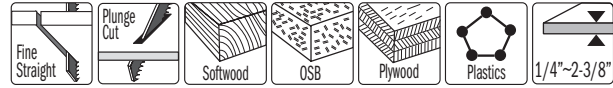

Straight cuts, fine finishing on upper side, on hard/softwood, plywood, OSB, laminates and plastics (1/4"~2-3/8"). Plunge cutting.

## JT301CD

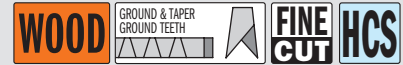
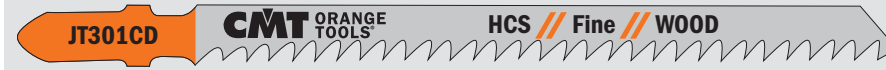

ORDER NO. T-Shank	SKIN PACK Quantity	I inches	L inches	TPI Teeth Per Inch	
JT301CD-5	5	3-1/2	4-1/2	8	100

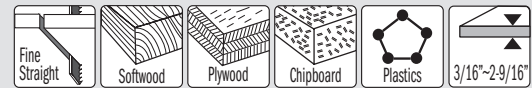

Straight cuts, good finishing, on hard/softwood, plywood, laminates and plastics (3/16"~2-9/16").

## JT234X

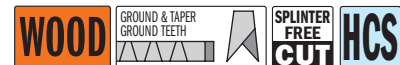

ORDER NO. T-Shank	SKIN PACK Quantity	I inches	L inches	TPI Teeth Per Inch	
JT234X-5	5	3-1/2	4-1/2	8-12	100

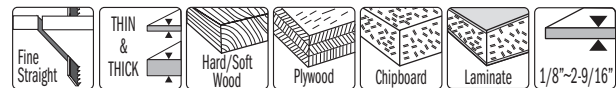

Extra-clean straight cuts, splinter-free finish, on hard/softwood, plywood, OSB, laminates (1/8"~2-9/16").

## JT101BIF



ORDER NO. T-Shank	SKIN PACK Quantity	I inches	L inches	TPI Teeth Per Inch	
JT101BIF-5	5	2-5/16	3-1/4	15	100

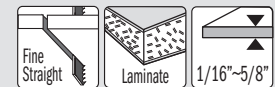

Splinter-free cuts. Special for all laminates, HPL and multiplex panels (1/16"~5/8").

## JT318VF



ORDER NO. T-Shank	SKIN PACK Quantity	I inches	L inches	TPI Teeth Per Inch	
JT318VF-5	5	4-3/8	5-1/4	10-15	100

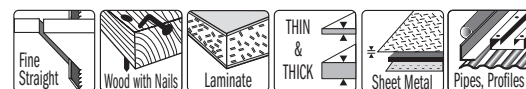

Straight cuts on wood with nails/metal, chipboard and laminate (<2-3/8"), sheet metal, aluminum profiles (1/8"~23/32"), glass fiber reinforced plastic/epoxy (<2-3/8").



# Jig Saw Blades

## JT118A



ORDER NO. T-Shank	SKIN PACK Quantity	I inches	L inches	TPI Teeth Per Inch	
JT118A-5	5	2	3	21	100

Straight cuts on thin sheet metals, ferrous and non-ferrous (3/64"~1/8").



## JT218A



ORDER NO. T-Shank	SKIN PACK Quantity	I inches	L inches	TPI Teeth Per Inch	
JT218A-5	5	2	3	21	100

Curve cuts on thin sheet metals, ferrous and non-ferrous (3/64"~1/8").



## JT118B



ORDER NO. T-Shank	SKIN PACK Quantity	I inches	L inches	TPI Teeth Per Inch	
JT118B-5	5	2	3	12	100

Straight cuts on medium-thick metals, ferrous and non-ferrous (1/8"~1/4").



## JT123X



ORDER NO. T-Shank	SKIN PACK Quantity	I inches	L inches	TPI Teeth Per Inch	
JT123X-5	5	3	4	10-21	100

Straight cuts on thin to thick sheet metals (1/16"~3/8"), pipes, profiles in plastic and aluminum (<1-1/4"), stainless steel (1/16"~1/8").

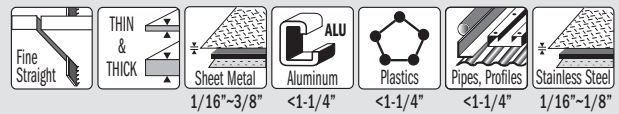

## JT127D



ORDER NO. T-Shank	SKIN PACK Quantity	I inches	L inches	TPI Teeth Per Inch	
JT127D-5	5	3	4	8	100

Special for aluminum, thin to thick (1/8"~5/8"), pipes and profiles, (<1-1/4") including plastic, fiberglass and epoxy.

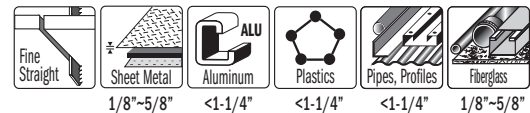
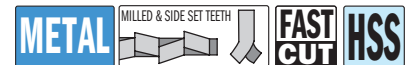

## JT718BF



ORDER NO. T-Shank	SKIN PACK Quantity	I inches	L inches	TPI Teeth Per Inch	
JT718BF-3	3	6-3/8	7-1/4	14	20

Special for sandwich materials & solid surfaces (<4-3/4").

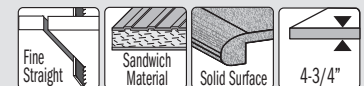

# Jig Saw Blades



## JT141HM



**CARBIDE TOOTH**



**SPECIAL**



**LONG LIFE**

**CARBIDE TIPPED**

ORDER NO. T-Shank	SKIN PACK Quantity	I inches	L inches	TPI Teeth Per Inch	
JT141HM-3	3	3	4	6	50

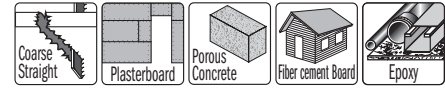

Plasterboard, fiber cement boards (<2"). Fiberglass/Epoxy (3/16"~3/4"), ETERNIT®, MDF, HDF.

## JT341HM



**CARBIDE TOOTH**



**SPECIAL**



**LONG LIFE**

**CARBIDE TIPPED**

ORDER NO. T-Shank	SKIN PACK Quantity	I inches	L inches	TPI Teeth Per Inch	
JT341HM-3	3	4-3/8	5-1/4	6	50

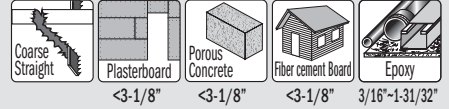

Plasterboard, fiber cement boards (<3"). Glass fiber reinforced plastic/epoxy (3/16"~1-31/32"), fiber cement, MDF, HDF.

## JT313AW



**new**

**SPECIAL**

**HCS**

ORDER NO. T-Shank	SKIN PACK Quantity	I inches	L inches	
JT313AW-3	3	4	6	100

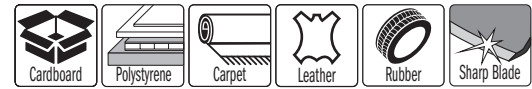

Cardboard, polystyrene, carpet, leather, rubber, fiberglass thermal insulation panels (<4").

## JT150RF



**CARBIDE TOOTH**



**new**

**SPECIAL**

**LONG LIFE**

**CARBIDE GRIT**

ORDER NO. T-Shank	SKIN PACK Quantity	I inches	L inches	
JT150RF-3	3	3	3-1/4	50

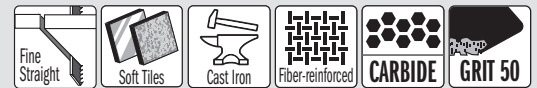

Soft ceramic tiles, cast iron (13/64"~3/8"), reinforced fiberglass.

## JT016 16-piece Jig Saw Blade Set

<b>2 PCS</b>	<b>JT144D</b>	<b>HCS</b>	<b>WOOD</b>	<b>FAST CUT</b>	<b>1 PC</b>	<b>JT141HM</b>	<b>HW</b>	<b>SPECIAL</b>	<b>LONG LIFE</b>
<b>2 PCS</b>	<b>JT101B</b>	<b>HCS</b>	<b>WOOD</b>	<b>FINE CUT</b>	<b>1 PC</b>	<b>JT123X</b>	<b>HSS</b>	<b>METAL</b>	<b>FAST CUT</b>
<b>2 PCS</b>	<b>JT101BR</b>	<b>HCS</b>	<b>WOOD</b>	<b>FINE SURFACE CUT</b>	<b>2 PCS</b>	<b>JT118A</b>	<b>HSS</b>	<b>METAL</b>	<b>BASIC CUT</b>
<b>1 PC</b>	<b>JT101BIF</b>	<b>BIM</b>	<b>WOOD</b>	<b>FINE CUT</b>	<b>2 PCS</b>	<b>JT118B</b>	<b>HSS</b>	<b>METAL</b>	<b>BASIC CUT</b>
<b>1 PC</b>	<b>JT101A0</b>	<b>HCS</b>	<b>WOOD</b>	<b>FINE CUT</b>	<b>2 PCS</b>	<b>JT218A</b>	<b>HSS</b>	<b>METAL</b>	<b>BASIC CUT</b>



15 Sets in End-cap display (minimum 15 pieces or multiple)



An assortment of 16 Jig Saw Blades featuring the 10 most popular blades for a variety of cutting needs:

- wood and timber (straight, curve cuts, course cutting and finishing);
- plasterboard, fiber cement, fiberglass, epoxy resins, and panels such as ETERNIT®;
- metal and sheet metal both thick and thin;
- stainless steel;
- aluminum and plastics.





# ACCESSORIES FOR MULTI-CUTTERS

## PRODUCTS PAGE

### STARLOCK®/STARLOCKPLUS®/STARLOCKMAX® Arbors

Radial Circular Saw Blades	113
Plunge & Flush-Cut for Wood	114
Precision Cut Japanese Tothing for Wood	114~116
Plunge & Flush-Cut for Wood & Nails	116~118
Blade for Wood & Metal	118-119
Blade for Metal	119
Radial Saw Blade for Masonry	120
Rasp for Masonry	121
Scraper for all Materials	122
Special Multi-Cutters & Set	123
Polishing Fleece	124
Sandpaper for Wood	124



### Universal/SuperCut Arbors

Plunge & Flush-Cut for Wood	126-127
Radial Saw Blade for Wood	128
Plunge & Flush-Cut for Wood & Metal	128~130
Radial Saw Blade for Wood & Metal	130
Scraper for all Materials	131
Radial Saw Blade for Masonry	131-132
Rasp for Masonry	132-133
Grout & Mortar Remover for Masonry	133
Polishing Fleece	133
Sandpaper for Wood	133
Multipurpose Sets for Multi-Cutters	134



## MAXIMIZING YOUR WORK PERFORMANCE



**HIGH CARBON STEEL**  
for cutting wood and plastic.



**BI-METAL WITH 8% COBALT**  
for cutting metal, nail embedded wood and plastic.



**BI-METAL WITH 8% COBALT WITH TITANIUM COATING**  
for cutting metal, nail embedded wood and plastic, providing extreme performance and 30% longer lifetime.



**TUNGSTEN CARBIDE TIPPED**  
for cutting wood, screws and nails, fiber cement board, plasterboard, plastic, sheet metal, copper, aluminium and stainless steel. Doubles tool lifetime.



**TUNGSTEN CARBIDE GRIT COATED**  
for routing joints and grooves, smaller cutouts, and routing recesses in a variety of materials: tiles, plasterboard, porous concrete, construction materials, epoxy and fiberglass.



**DIAMOND GRIT COATED**  
for routing joints and grooves, smaller cutouts, and routing recesses in a variety of materials: tiles, plasterboard, porous concrete, construction materials, epoxy and fiberglass. Extreme performance and longer lifetime.



# SAWING & CUTTING



## SCRAPING & CUTTING



## ROUTING & GRINDING



### MULTI MATERIALS



## SANDING, CLEANING & POLISHING



### APPLICATIONS

- SANDING
- SAWING
- GROUTING
- PLASTIC CUTTING
- CARPET REMOVAL
- PLUNGE CUTTING
- WOOD CUTTING
- SAWING LAMINATE & HARDWOOD FLOORING
- TUBE TRIMMING & CUTTING
- NAIL CUTTING



**THE RIGHT BLADE FOR THE BEST RESULTS!**

Quick reference charts and pictograms help you choose the right blade for your application.



**STARLOCK® : THE NEW SYSTEM FOR MULTI-CUTTER POWER TOOLS**

STARLOCK® enables extremely reliable and fast accessory changes in a record time of less than 3 seconds. It also guarantees a secure fit and therefore maximum power transfer. The result: up to around 35% faster performance depending on the accessory, noticeably improved precision and reduced noise. To protect the individual tools from overload and damage, the system is divided into 3 performance classes: STARLOCK®, STARLOCKPLUS® and STARLOCKMAX®. The performance potential of a multi-cutter tool can only be fully exploited with the right accessories. The exceptional quality and service life of our accessories combined with the perfect results delivers excellent value for money.

POWERTOOL COMPATIBILITY CHART FOR CMT MULTI-CUTTER ACCESSORIES	STARLOCK	STARLOCK PLUS	STARLOCK MAX
	SL	SLP	SLM
AEG®	●		
BOSCH®	●	●	●
CMT®	●	●	
CRAFTSMAN®	●	●	
DEWALT®	●		
DREMEL®	●		
EINHELL®	●		
FEIN® MULTITALENT®/MULTIMASTER®	●	●	
FEIN® SUPERCUT AUTOMOTIVE/CONSTRUCTION	●	●	●
FESTOOL® VECTURO®	●	●	●
HITACHI®	●		
MAKITA®	●	●	
METABO®	●		
MILWAUKEE®	●	●	
RIDGID®	●		
ROCKWELL®	●	●	
RYOBI®	●	●	
SKIL®	●	●	
WORX®	●		

Some brands may require an adapter

**OMF113 STARLOCK**

3-3/8" RADIAL SAW BLADE FOR SOFT MATERIALS, SEGMENTED

**MULTI-MAT**

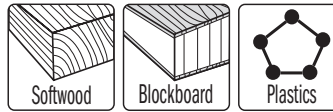
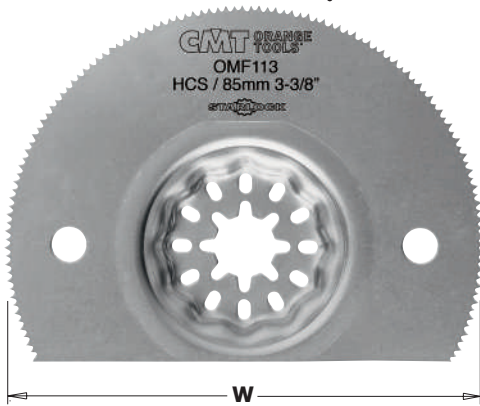

ORDER NO. STARLOCK®	PACK Quantity	W inches	K inches	TS inches	TPI Teeth Per Inch	
<b>OMF113-X1</b>	1 in clamshell	3-3/8	1/32	1/16	17	<b>100</b>
<b>OMF113-X5</b>	5 in clamshell	3-3/8	1/32	1/16	17	<b>15</b>

**OMF106 STARLOCK**

3-3/8" RADIAL SAW BLADE FOR WOOD&METAL, SEGMENTED

**WOOD&METAL**

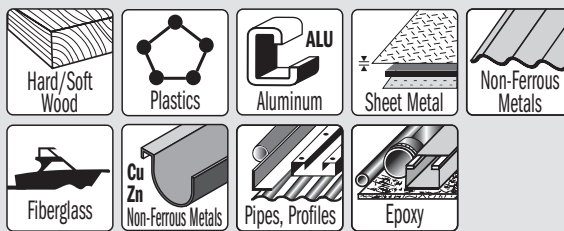

ORDER NO. STARLOCK®	PACK Quantity	W inches	K inches	TS inches	TPI Teeth Per Inch	
<b>OMF106-X1</b>	1 in clamshell	3-3/8	1/64	3/64	19	<b>100</b>
<b>OMF106-X5</b>	5 in clamshell	3-3/8	1/64	3/64	19	<b>50</b>

**OMF174 STARLOCK**

3-3/8" CIRCULAR SAW BLADE FOR WOOD&METAL

**WOOD&METAL**

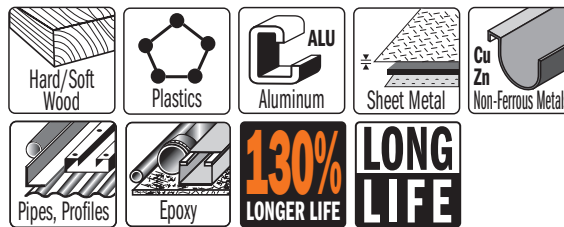
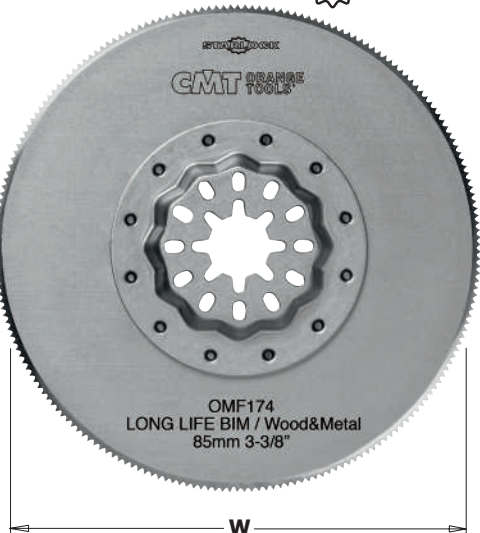

ORDER NO. STARLOCK®	PACK Quantity	W inches	K inches	TS inches	TPI Teeth Per Inch	
<b>OMF174-X1</b>	1 in clamshell	3-3/8	1/32	3/64	20	<b>100</b>
<b>OMF174-X5</b>	5 in clamshell	3-3/8	1/32	3/64	20	<b>50</b>



**OMF133 STARLOCK**

1-3/8" PLUNGE CUT BLADE FOR WOOD

**WOOD**

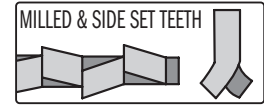
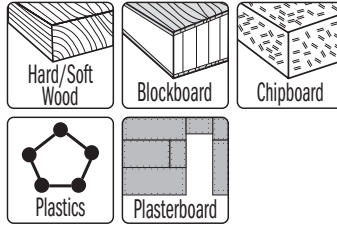

**HCS**

ORDER NO. STARLOCK®	Pack Quantity	W inches	I inches	TS inches	TPI Teeth Per Inch	
OMF133-X1	1 in clamshell	1-3/8	2	1/16	18	70
OMF133-X5	5 in clamshell	1-3/8	2	1/16	18	34
OMF133-X50	50 in masterpack	1-3/8	2	1/16	18	8

**OMF126 STARLOCK**

1-3/8" PRECISION CUT BLADE WITH JAPANESE TOOTHING FOR WOOD

**WOOD**

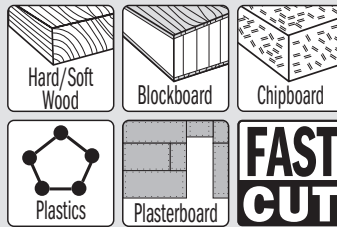
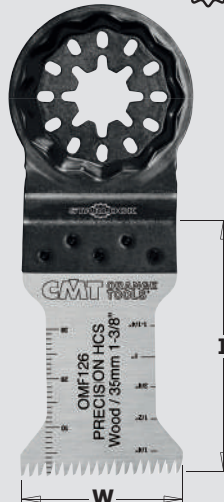

**HCS**

ORDER NO. STARLOCK®	Pack Quantity	W inches	I inches	TS inches	TPI Teeth Per Inch	
OMF126-X1	1 in clamshell	1-3/8	2	1/16	14	70
OMF126-X5	5 in clamshell	1-3/8	2	1/16	14	34
OMF126-X50	50 in masterpack	1-3/8	2	1/16	14	8



**JAPANESE TOOTHING**

**OMF233 STARLOCK**

1-3/4" PRECISION CUT BLADE WITH JAPANESE TOOTHING FOR WOOD

**WOOD**

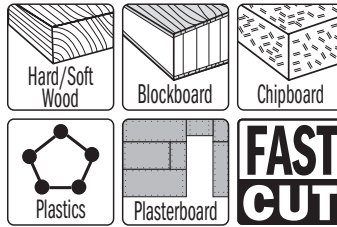
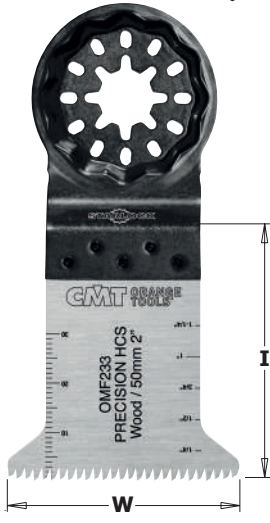

**HCS**

ORDER NO. STARLOCK®	Pack Quantity	W inches	I inches	TS inches	TPI Teeth Per Inch	
OMF233-X1	1 in clamshell	1-3/4	2	1/16	14	70
OMF233-X5	5 in clamshell	1-3/4	2	1/16	14	34
OMF233-X50	50 in masterpack	1-3/4	2	1/16	14	8

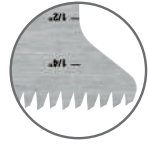

**JAPANESE TOOTHING**

**OMF230 STARLOCK**

2-9/16" PRECISION CUT BLADE WITH JAPANESE TOOTHING FOR WOOD

**WOOD**

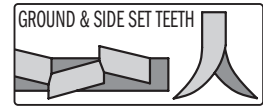
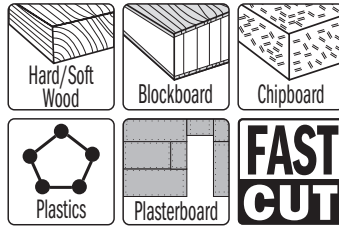

**HCS**

ORDER NO. STARLOCK®	Pack Quantity	W inches	I inches	TS inches	TPI Teeth Per Inch	
<b>OMF230-X1</b>	1 in clamshell	2-9/16	2	1/16	14	<b>70</b>
<b>OMF230-X5</b>	5 in clamshell	2-9/16	2	1/16	14	<b>34</b>
<b>OMF230-X50</b>	50 in masterpack	2-9/16	2	1/16	14	<b>8</b>



**JAPANESE TOOTHING**

**OMF205 STARLOCK**

1-3/8" PRECISION CUT BLADE WITH JAPANESE TOOTHING FOR WOOD

**WOOD**

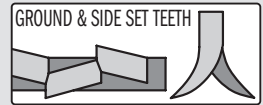
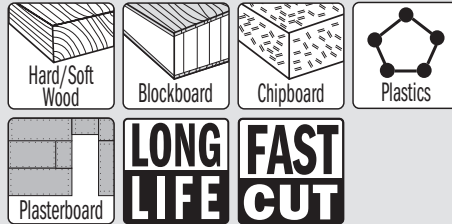
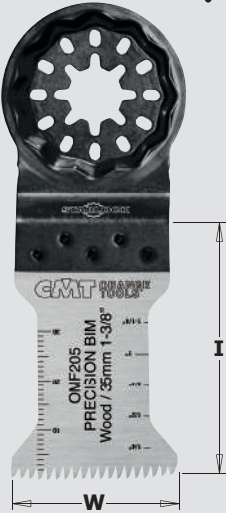

**BIM 8% Co**

ORDER NO. STARLOCK®	Pack Quantity	W inches	I inches	TS inches	TPI Teeth Per Inch	
<b>OMF205-X1</b>	1 in clamshell	1-3/8	2	1/16	14	<b>70</b>
<b>OMF205-X5</b>	5 in clamshell	1-3/8	2	1/16	14	<b>34</b>
<b>OMF205-X50</b>	50 in masterpack	1-3/8	2	1/16	14	<b>8</b>

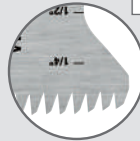

**JAPANESE TOOTHING**  
Reduced tooth height for longer lifetime

**OMF232 STARLOCK**

1-3/4" PRECISION CUT BLADE WITH JAPANESE TOOTHING FOR WOOD

**WOOD**

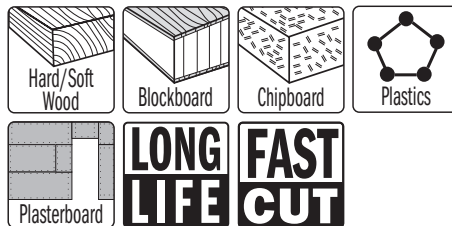

**BIM 8% Co**

ORDER NO. STARLOCK®	Pack Quantity	W inches	I inches	TS inches	TPI Teeth Per Inch	
<b>OMF232-X1</b>	1 in clamshell	1-3/4	2	1/16	14	<b>70</b>
<b>OMF232-X5</b>	5 in clamshell	1-3/4	2	1/16	14	<b>34</b>
<b>OMF232-X50</b>	50 in masterpack	1-3/4	2	1/16	14	<b>8</b>

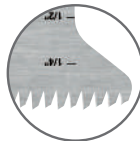

**JAPANESE TOOTHING**  
Reduced tooth height for longer lifetime

**OMF229 STARLOCK**

2-9/16" PRECISION CUT BLADE WITH JAPANESE TOOTHING FOR WOOD

**WOOD**

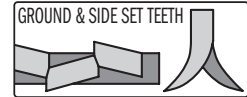
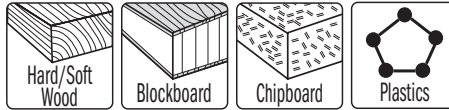

**BIM**  
8% Co

ORDER NO. STARLOCK®	PACK Quantity	W inches	I inches	TS inches	TPI Teeth Per Inch	
OMF229-X1	1 in clamshell	2-9/16	2	1/16	14	70
OMF229-X5	5 in clamshell	2-9/16	2	1/16	14	34
OMF229-X50	50 in masterpack	2-9/16	2	1/16	14	8



**JAPANESE TOOTHING**  
Reduced tooth height for longer lifetime

**OMF208 STARLOCK PLUS**

2-9/16" PRECISION CUT BLADE WITH JAPANESE TOOTHING FOR WOOD

**WOOD**

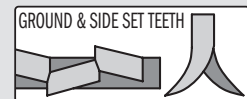
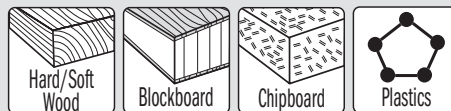

**BIM**  
8% Co

ORDER NO. STARLOCKPLUS®	PACK Quantity	W inches	I inches	TS inches	TPI Teeth Per Inch	
OMF208-X1	1 in clamshell	2-9/16	2	1/16	14	70
OMF208-X5	5 in clamshell	2-9/16	2	1/16	14	34
OMF208-X50	50 in masterpack	2-9/16	2	1/16	14	8



**JAPANESE TOOTHING**  
Reduced tooth height for longer lifetime

**OMF184 STARLOCK**

3/8" PLUNGE CUT BLADE FOR WOOD & NAILS

**WOOD&NAILS**

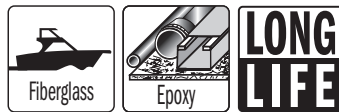
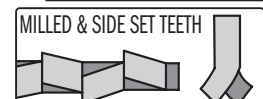

**BIM**  
8% Co

ORDER NO. STARLOCK®	PACK Quantity	W inches	I inches	TS inches	TPI Teeth Per Inch	
OMF184-X1	1 in clamshell	3/8	1-3/16	1/16	18	70
OMF184-X1	1 in clamshell	3/8	1-3/16	1/16	18	34
OMF184-X50	50 in masterpack	3/8	1-3/16	1/16	18	8

**OMF183 STARLOCK**

13/16" PLUNGE CUT BLADE FOR WOOD & NAILS



**WOOD&NAILS**

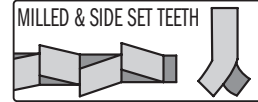

**BIM**  
8% Co

ORDER NO. STARLOCK®	Pack Quantity	W inches	I inches	TS inches	TPI Teeth Per Inch	
<b>OMF183-X1</b>	1 in clamshell	13/16	1-11/32	1/16	18	<b>70</b>
<b>OMF183-X5</b>	5 in clamshell	13/16	1-11/32	1/16	18	<b>34</b>
<b>OMF183-X50</b>	50 in masterpack	13/16	1-11/32	1/16	18	<b>8</b>

**OMF160 STARLOCK**

1-3/8" PLUNGE CUT BLADE FOR WOOD & NAILS

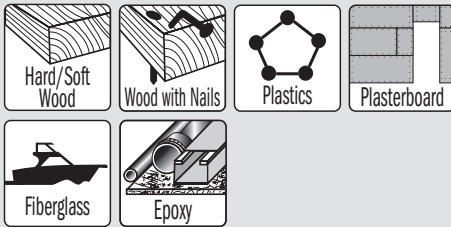

**WOOD&NAILS**

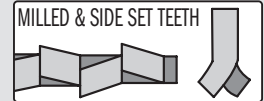

**BIM**  
8% Co

ORDER NO. STARLOCK®	Pack Quantity	W inches	I inches	TS inches	TPI Teeth Per Inch	
<b>OMF160-X1</b>	1 in clamshell	1-3/8	2	1/16	18	<b>70</b>
<b>OMF160-X5</b>	5 in clamshell	1-3/8	2	1/16	18	<b>34</b>
<b>OMF160-X50</b>	50 in masterpack	1-3/8	2	1/16	18	<b>8</b>



Watch the video on **YouTube**

**OMF221 STARLOCK**

2" PLUNGE CUT BLADE FOR WOOD & NAILS

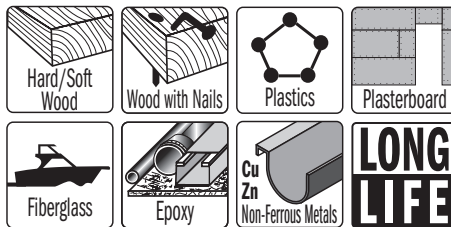

**WOOD&NAILS**

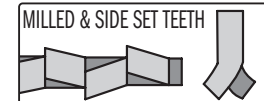

**BIM**  
8% Co

ORDER NO. STARLOCK®	Pack Quantity	W inches	I inches	TS inches	TPI Teeth Per Inch	
<b>OMF221-X1</b>	1 in clamshell	2	2	1/16	18	<b>70</b>
<b>OMF221-X5</b>	5 in clamshell	2	2	1/16	18	<b>34</b>
<b>OMF221-X50</b>	50 in masterpack	2	2	1/16	18	<b>8</b>



**OMF228 STARLOCK**

2-9/16" PLUNGE CUT BLADE FOR WOOD & NAILS

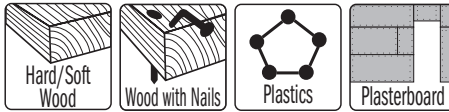

**WOOD&NAILS**

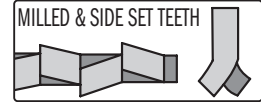

**LONG LIFE**

**BIM 8% Co**

ORDER NO. STARLOCK®	Pack Quantity	W inches	I inches	TS inches	TPI Teeth Per Inch	
<b>OMF228-X1</b>	1 in clamshell	2-9/16	2	1/16	18	<b>70</b>
<b>OMF228-X5</b>	5 in clamshell	2-9/16	2	1/16	18	<b>34</b>
<b>OMF228-X50</b>	50 in masterpack	2-9/16	2	1/16	18	<b>8</b>

**OMF161 STARLOCK PLUS**

2-9/16" PLUNGE CUT BLADE FOR WOOD & NAILS



**WOOD&NAILS**

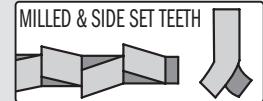

**LONG LIFE**

**BIM 8% Co**

ORDER NO. STARLOCKPLUS®	Pack Quantity	W inches	I inches	TS inches	TPI Teeth Per Inch	
<b>OMF161-X1</b>	1 in clamshell	2-9/16	2	1/16	18	<b>70</b>
<b>OMF161-X5</b>	5 in clamshell	2-9/16	2	1/16	18	<b>34</b>
<b>OMF161-X50</b>	50 in masterpack	2-9/16	2	1/16	18	<b>8</b>

**OMF222 STARLOCK**

1-1/8" PLUNGE CUT BLADE FOR WOOD & METAL

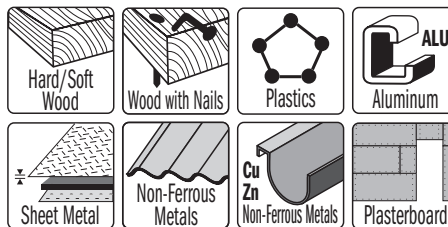
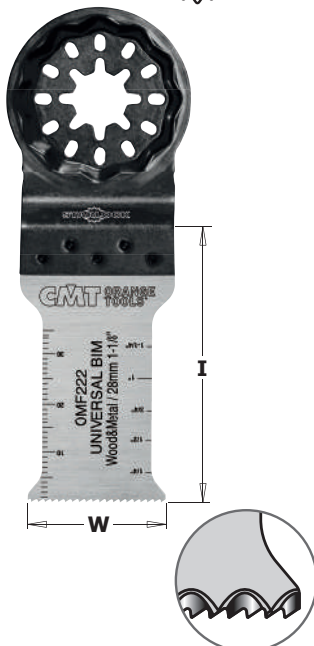

**WOOD&METAL**



**130% LONGER LIFE LONG LIFE**

**BIM 8% Co**

ORDER NO. STARLOCK®	Pack Quantity	W inches	I inches	TS inches	TPI Teeth Per Inch	
<b>OMF222-X1</b>	1 in clamshell	1-1/8	2-11/64	1/16	18	<b>70</b>
<b>OMF222-X5</b>	5 in clamshell	1-1/8	2-11/64	1/16	18	<b>34</b>
<b>OMF222-X50</b>	50 in masterpack	1-1/8	2-11/64	1/16	18	<b>8</b>

**WAVY UNIVERSAL TOOTHING**

**OMF223 STARLOCK** 1-3/4" PLUNGE CUT BLADE FOR WOOD & METAL

**WOOD&METAL**

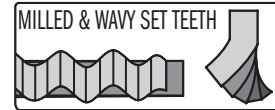
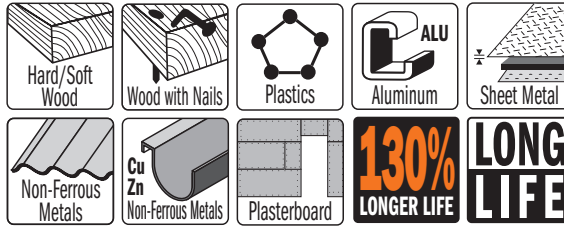

**BIM**  
8% Co

**130% LONGER LIFE** **LONG LIFE**

ORDER NO. STARLOCK®	PACK Quantity	W inches	I inches	TS inches	TPI Teeth Per Inch	
OMF223-X1	1 in clamshell	1-3/4	2-11/64	1/16	18	70
OMF223-X5	5 in clamshell	1-3/4	2-11/64	1/16	18	34
OMF223-X50	50 in masterpack	1-3/4	2-11/64	1/16	18	8

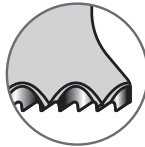

**WAVY UNIVERSAL TOOTHING**

**OMF157 STARLOCK** 1-3/16" PLUNGE CUT BLADE FOR METAL

**METAL**

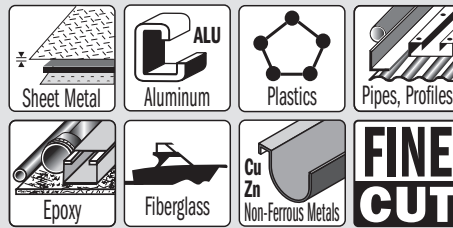

**BIM**  
8% Co

**FINE CUT**

ORDER NO. STARLOCK®	PACK Quantity	W inches	I inches	TS inches	TPI Teeth Per Inch	
OMF157-X1	1 in clamshell	1-3/16	2	3/64	21	70
OMF157-X5	5 in clamshell	1-3/16	2	3/64	21	34
OMF157-X50	50 in masterpack	1-3/16	2	3/64	21	8

**OMF237 STARLOCK PLUS** 1-1/4" CARBIDE + TIN COATING PLUNGE & FLUSH-CUT FOR METAL

**METAL**



**new**

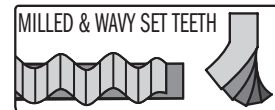
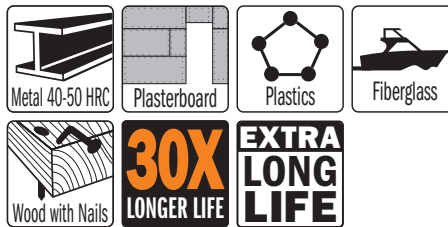

**BIM**  
**TiN**

**30X LONGER LIFE** **EXTRA LONG LIFE**

ORDER NO. STARLOCKPLUS®	PACK Quantity	W inches	I inches	TS inches	TPI Teeth Per Inch	
OMF237-X1	1 in clamshell	1-1/4	2-3/8	3/64	21	70

**OMF118 STARLOCK**

**2-15/16" CARBIDE GRIT RADIAL SAW BLADE, SEGMENTED**

**MASONRY**

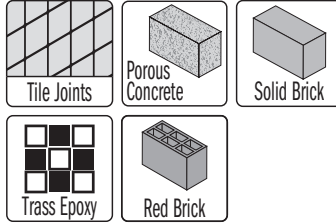
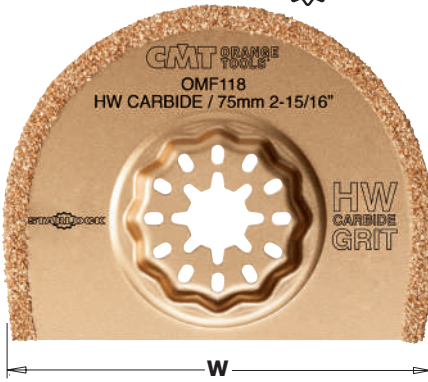

ORDER NO. STARLOCK®	Pack Quantity	W inches	K inches	
<b>OMF118-X1</b>	1 in clamshell	2-15/16	3/32	<b>80</b>
<b>OMF118-X5</b>	5 in clamshell	2-15/16	3/32	<b>40</b>

**OMF125 STARLOCK**

**2-15/16" CARBIDE GRIT RADIAL SAW BLADE, SEGMENTED**

**MASONRY**

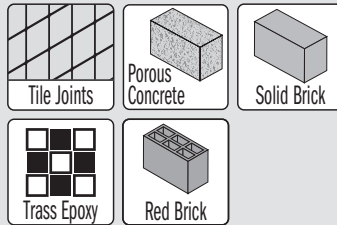

ORDER NO. STARLOCK®	Pack Quantity	W inches	K inches	
<b>OMF125-X1</b>	1 in clamshell	2-15/16	3/64	<b>100</b>
<b>OMF125-X5</b>	5 in clamshell	2-15/16	3/64	<b>40</b>

**OMF114 STARLOCK**

**2-15/16" DIAMOND COATED RADIAL SAW BLADE, SEGMENTED**

**MASONRY**

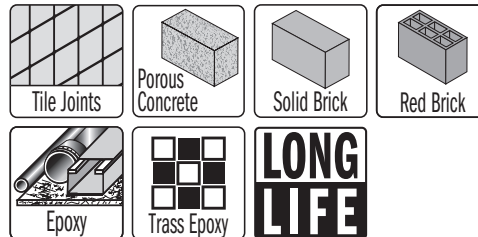

ORDER NO. STARLOCK®	Pack Quantity	W inches	K inches	
<b>OMF114-X1</b>	1 in clamshell	2-15/16	3/32	<b>115</b>
<b>OMF114-X5</b>	5 in clamshell	2-15/16	3/32	<b>56</b>

**OMF002 STARLOCK PLUS**

1-3/4" CARBIDE GRIT FINGERTIP RASP - DOUBLE-SIDED

**MASONRY**

**CARBIDE GRIT**

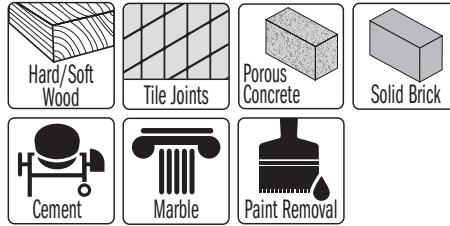

ORDER NO. STARLOCKPLUS®	PACK Quantity	W inches	I inches	
<b>OMF002-X1</b>	1 in clamshell	1-5/16	1-3/4	<b>250</b>

**OMF001 STARLOCK**

3-1/8" CARBIDE GRIT DELTA RASP

**MASONRY**

**CARBIDE GRIT**

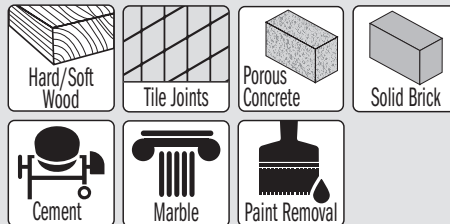
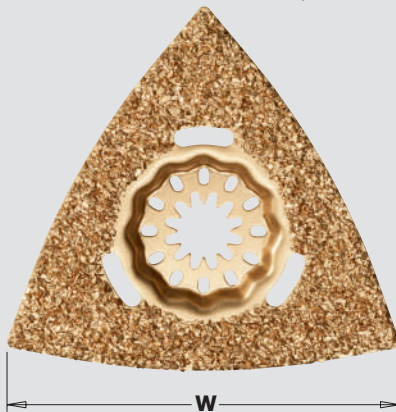

ORDER NO. STARLOCK®	PACK Quantity	W inches	
<b>OMF001-X1</b>	1 in clamshell	3-1/8	<b>250</b>

**OMF243 STARLOCK MAX**

2-3/8" DIAMOND COATED SAW BLADE, SEGMENTED

**MASONRY**

**DIAMOND GRIT**

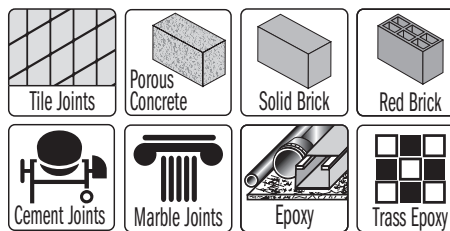

**LONG LIFE**

ORDER NO. STARLOCKMAX®	PACK Quantity	W inches	K inches	
<b>OMF243-X1</b>	1 in clamshell	2-3/8	3/32	<b>115</b>



**OMF226 STARLOCK**

2-1/16" RIGID SCRAPER BLADE FOR ALL MATERIALS

**MULTI-MAT**

**HL**

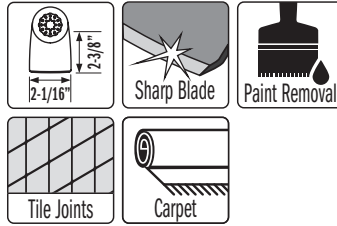

ORDER NO. STARLOCK®	PACK Quantity	W inches	K inches	
<b>OMF226-X1</b>	1 in clamshell	2-1/16	1/32	<b>100</b>

**OMF165 STARLOCK**

2-1/16" FLEXIBLE SCRAPER BLADE FOR ALL MATERIALS

**MULTI-MAT**

**HL**

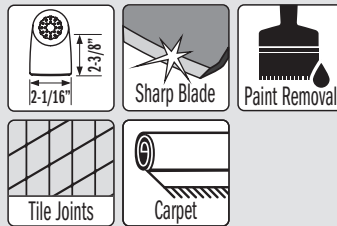

ORDER NO. STARLOCK®	PACK Quantity	W inches	K inches	
<b>OMF165-X1</b>	1 in clamshell	2-1/16	1/64	<b>100</b>

**OMF245 STARLOCK**

2-3/4" "MUSHROOM-SHAPED" CUTTING BLADE FOR ALL MATERIALS

**MULTI-MAT**

**HL**

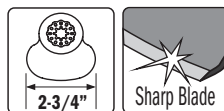

ORDER NO. STARLOCK®	PACK Quantity	W inches	K inches	
<b>OMF245-X5</b>	1 in clamshell	2-3/4	1/64	<b>50</b>

**OMF201 STARLOCK PLUS**

5/8" ANGLED GOUGING BLADE

**SPECIAL**

**HCS**



ORDER NO. STARLOCKPLUS®	PACK Quantity	K inches	W inches	I inches	
OMF201-X1	1 in clamshell	5/32	5/8	7/16	70

**OMF251 STARLOCK**

1-5/8" MULTI-KNIFE WITH THREE CUTTING EDGES, SEGMENTED

**SPECIAL**

**HCS**

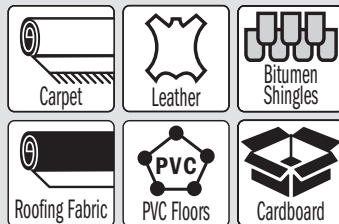

ORDER NO. STARLOCK®	PACK Quantity	W inches	I inches	
OMF251-X1	1 in clamshell	1-5/8	1-5/8	70

**OMF-X4 STARLOCK**

4 piece General Purpose Set for Multi-Cutters

**WOOD**  
**WOOD&NAILS**

- 2 blades with Japanese Tothing for all wood products, blockboard, plasterboard and plastics.
  - 2 blades in BIM for all wood products, blockboard, plasterboard, fiberglass, epoxy resin and soft plastics.
- Excellent for cutting wood with embedded nails up to 5mm in diameter and even masonry, like porous concrete.



8 Sets in End-cap display  
(minimum 8 pieces or multiple)



ORDER NO.	PACK Quantity	MATERIAL	W inches	I inches	TS inches	TPI
OMF126-X1	1	HCS	1-3/8	2	1/16	14
OMF160-X1	1	BIM	1-3/8	2	1/16	18
OMF221-X1	1	BIM	2	2	1/16	18
OMF230-X1	1	HCS	2-9/16	2	1/16	14

**OMF136 STARLOCK**

3-5/8" DELTA SANDING PAD. PERFORATED

**MULTI-MAT**

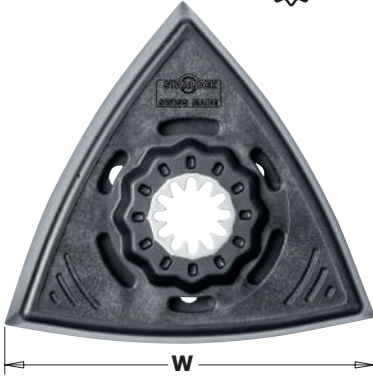

ORDER NO. STARLOCK®	PACK Quantity	W inches	
<b>OMF136-X1</b>	1 in clamshell	3-5/8	<b>40</b>

**OMA30000**

3-5/8" DELTA POLISHING FLEECE. PERFORATED

**MULTI-MAT**

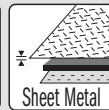
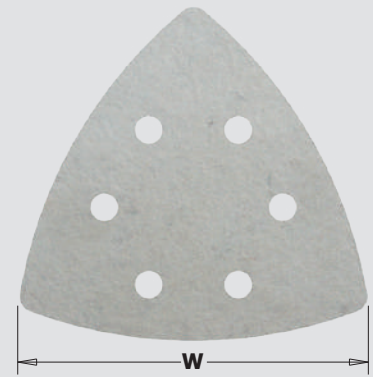

ORDER NO.	PACK Quantity	W inches	
<b>OMA30000-X4</b>	4 in clamshell	3-5/8	<b>10</b>

**OMA30**

3-5/8" ALUMINUM-OXIDE DELTA SANDPAPER FOR WOOD. PERFORATED

**WOOD**

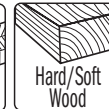
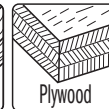
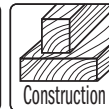
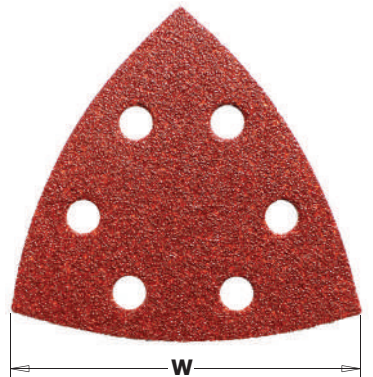

ORDER NO.	PACK Quantity	W inches	GRIT	
<b>OMA30040-X10</b>	10 in clamshell	3-5/8	40	<b>10</b>
<b>OMA30060-X10</b>	10 in clamshell	3-5/8	60	<b>10</b>
<b>OMA30080-X10</b>	10 in clamshell	3-5/8	80	<b>10</b>
<b>OMA30100-X10</b>	10 in clamshell	3-5/8	100	<b>10</b>
<b>OMA30120-X10</b>	10 in clamshell	3-5/8	120	<b>10</b>
<b>OMA30180-X10</b>	10 in clamshell	3-5/8	180	<b>10</b>
<b>OMA30240-X10</b>	10 in clamshell	3-5/8	240	<b>10</b>

**THE RIGHT BLADE FOR THE BEST RESULTS!**

Quick reference charts and pictograms help you choose the right blade for your application.



**CMT UNIVERSAL ARBOR FITS MOST MULTI-CUTTERS ON THE MARKET**

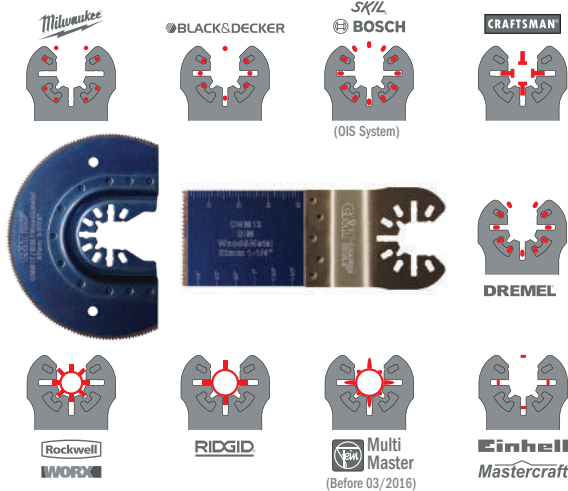

This tool mount also enables the accessory to be repositioned in 30-degree steps.

**ARBOR FOR FEIN® SUPERCUT AND FESTOOL® VECTURO®**

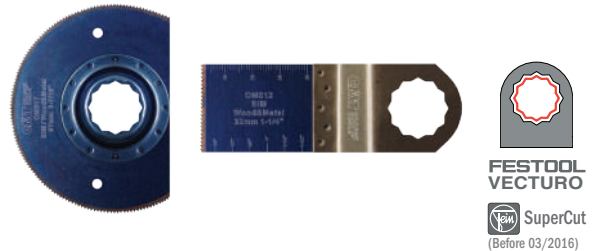

This tool mount also enables the accessory to be repositioned in 30-degree steps.

**OMA31**



**Universal Adapters**

This universal adapter permits easy attachment of CMT accessories to most multi-cutter tools. Fits snugly and does not slip. Ideal for BOSCH®, CHICAGO®, CRAFTSMAN®, DREMEL®, FEIN®, MAKITA®, MILWAUKEE®, MASTERCRAFT®, OZITO®, AEG®, RIDGID®, ROCKWELL®, SMART®, WORX®.

ORDER NO.	Pack Quantity	
OMA31-X2	2 in clamshell	10



Accessories for Multi-Cutters

**OMM01 OMS01**

Universal Arbor



Arbor for  
FEIN® SuperCut  
FESTOOL® VECTURO®



**3/8" PLUNGE AND FLUSH-CUT BLADE FOR WOOD**

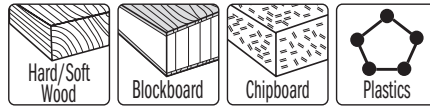

**WOOD**

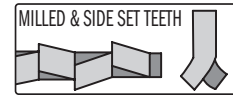

ORDER NO. Universal Arbor	ORDER NO. Arbor for FEIN® SuperCut	Pack Quantity	W inches	I inches	TPI	
<b>OMM01-X1</b>	<b>OMS01-X1</b>	1 in clamshell	3/8	1-1/8	18	<b>10</b>

**OMM02 OMS02**

Universal Arbor



Arbor for  
FEIN® SuperCut  
FESTOOL® VECTURO®



**7/8" PLUNGE AND FLUSH-CUT BLADE FOR WOOD**

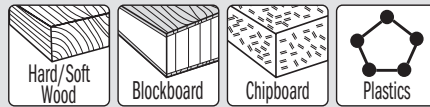

**WOOD**

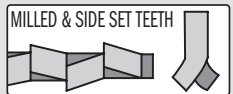

ORDER NO. Universal Arbor	ORDER NO. Arbor for FEIN® SuperCut	Pack Quantity	W inches	I inches	TPI	
<b>OMM02-X1</b>	<b>OMS02-X1</b>	1 in clamshell	7/8	1-7/8	18	<b>10</b>
<b>OMM02-X5</b>	<b>OMS02-X5</b>	5 in clamshell	7/8	1-7/8	18	<b>5</b>

**OMM03 OMS03**

Universal Arbor



Arbor for  
FEIN® SuperCut  
FESTOOL® VECTURO®



**1-1/8" PLUNGE AND FLUSH-CUT BLADE FOR WOOD**

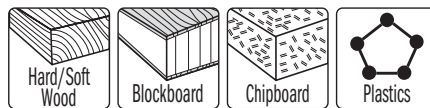

**WOOD**

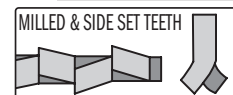

ORDER NO. Universal Arbor	ORDER NO. Arbor for FEIN® SuperCut	Pack Quantity	W inches	I inches	TPI	
<b>OMM03-X1</b>	<b>OMS03-X1</b>	1 in clamshell	1-1/8	1-7/8	18	<b>10</b>
<b>OMM03-X50</b>	<b>OMS03-X50</b>	50 in masterpack	1-1/8	1-7/8	18	<b>2</b>

**OMM04 OMS04**

Universal Arbor

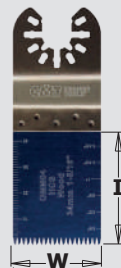

Arbor for  
FEIN® SuperCut  
FESTOOL® VECTURO®



**1-5/16" PRECISION CUT BLADE - JAPANESE TOOTHING FOR WOOD**

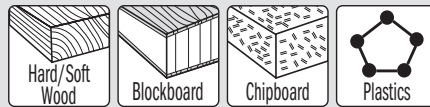

**WOOD**

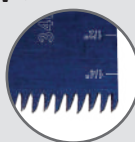

**JAPANESE TOOTHING**



ORDER NO. Universal Arbor	ORDER NO. Arbor for FEIN® SuperCut	Pack Quantity	W inches	I inches	TPI	
<b>OMM04-X1</b>	<b>OMS04-X1</b>	1 in clamshell	1-5/16	1-5/8	14	<b>10</b>
<b>OMM04-X5</b>	<b>OMS04-X5</b>	5 in clamshell	1-5/16	1-5/8	14	<b>5</b>
<b>OMM04-X50</b>	<b>OMS04-X50</b>	50 in masterpack	1-5/16	1-5/8	14	<b>2</b>

**OMM05 OMS05**

**1-5/16" PLUNGE AND FLUSH-CUT BLADE FOR WOOD**

**WOOD**

Universal Arbor



Arbor for  
FEIN® SuperCut  
FESTOOL® VECTURO®

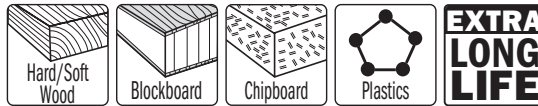

**BIM**  
8% Co

ORDER NO. Universal Arbor	ORDER NO. Arbor for FEIN® Supercut	Pack Quantity	W inches	I inches	TPI	
<b>OMM05-X1</b>	<b>OMS05-X1</b>	1 in clamshell	1-5/16	1-5/8	18	<b>10</b>
<b>OMM05-X5</b>	<b>OMS05-X5</b>	5 in clamshell	1-5/16	1-5/8	18	<b>5</b>
<b>OMM05-X50</b>	<b>OMS05-X50</b>	50 in masterpack	1-5/16	1-5/8	18	<b>2</b>

**OMM36 OMS36**

**1-3/4" PRECISION CUT BLADE - JAPANESE TOOTHING FOR WOOD**

**WOOD**

Universal Arbor



Arbor for  
FEIN® SuperCut  
FESTOOL® VECTURO®

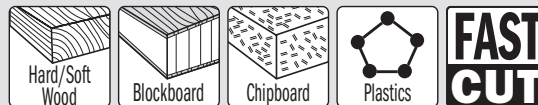

**HCS**

ORDER NO. Universal Arbor	ORDER NO. Arbor for FEIN® Supercut	Pack Quantity	W inches	I inches	TPI	
<b>OMM36-X5</b>	<b>OMS36-X5</b>	5 in clamshell	1-3/4	2	14	<b>5</b>
<b>OMM36-X50</b>	<b>OMS36-X50</b>	50 in masterpack	1-3/4	2	14	<b>2</b>

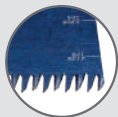

**JAPANESE TOOTHING**

**OMM06 OMS06**

**2-11/16" PRECISION CUT BLADE - JAPANESE TOOTHING FOR WOOD**

**WOOD**

Universal Arbor

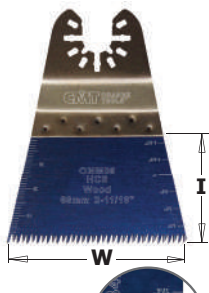

Arbor for  
FEIN® SuperCut  
FESTOOL® VECTURO®

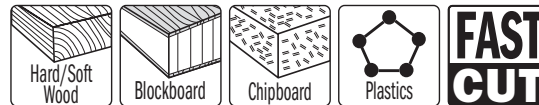

**HCS**

ORDER NO. Universal Arbor	ORDER NO. Arbor for FEIN® Supercut	Pack Quantity	W inches	I inches	TPI	
<b>OMM06-X1</b>	<b>OMS06-X1</b>	1 in clamshell	2-11/16	1-5/8	14	<b>10</b>
<b>OMM06-X5</b>	<b>OMS06-X5</b>	5 in clamshell	2-11/16	1-5/8	14	<b>5</b>
<b>OMM06-X50</b>	<b>OMS06-X50</b>	50 in masterpack	2-11/16	1-5/8	14	<b>2</b>

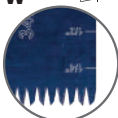

**JAPANESE TOOTHING**

**OMM07 OMS07**

**2-11/16" PRECISION CUT BLADE - JAPANESE TOOTHING FOR WOOD**

**WOOD**

Universal Arbor

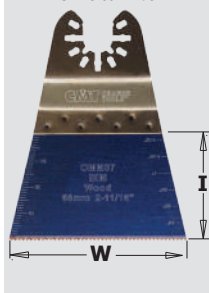

Arbor for  
FEIN® SuperCut  
FESTOOL® VECTURO®

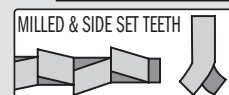
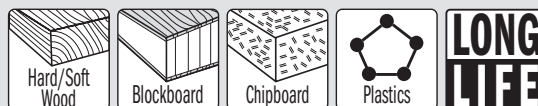

**BIM**  
8% Co

ORDER NO. Universal Arbor	ORDER NO. Arbor for FEIN® Supercut	Pack Quantity	W inches	I inches	TPI	
<b>OMM07-X1</b>	<b>OMS07-X1</b>	1 in clamshell	2-11/16	1-5/8	18	<b>10</b>
<b>OMM07-X5</b>	<b>OMS07-X5</b>	5 in clamshell	2-11/16	1-5/8	18	<b>5</b>
<b>OMM07-X50</b>	<b>OMS07-X50</b>	50 in masterpack	2-11/16	1-5/8	18	<b>2</b>

# Accessories for Multi-Cutters

## OMM08

Universal Arbor

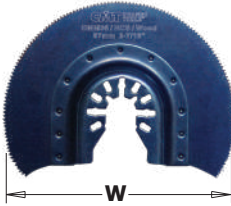

## OMS08

Arbor for  
FEIN® SuperCut  
FESTOOL® VECTURO®



### 3-7/16" RADIAL SAW BLADE FOR WOOD, SEGMENTED

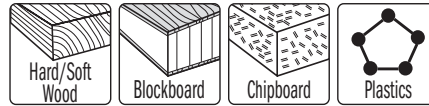

### WOOD



ORDER NO. Universal Arbor	ORDER NO. Arbor for FEIN® SuperCut	Pack Quantity	W inches	TPI	
<b>OMM08-X1</b>	<b>OMS08-X1</b>	1 in clamshell	3-7/16	18	<b>10</b>

## OMM09

Universal Arbor



## OMS09

Arbor for  
FEIN® SuperCut  
FESTOOL® VECTURO®



### 3/8" PLUNGE AND FLUSH-CUT BLADE FOR WOOD & METAL



### WOOD&METAL

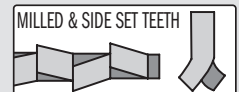

ORDER NO. Universal Arbor	ORDER NO. Arbor for FEIN® SuperCut	Pack Quantity	W inches	I inches	TPI	
<b>OMM09-X1</b>	<b>OMS09-X1</b>	1 in clamshell	3/8	1-1/8	18	<b>10</b>
<b>OMM09-X5</b>	<b>OMS09-X5</b>	5 in clamshell	3/8	1-1/8	18	<b>5</b>
<b>OMM09-X50</b>	<b>OMS09-X50</b>	50 in masterpack	3/8	1-1/8	18	<b>2</b>

## OMM10

Universal Arbor

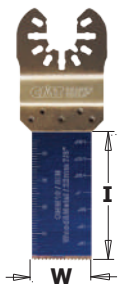

## OMS10

Arbor for  
FEIN® SuperCut  
FESTOOL® VECTURO®



### 7/8" PLUNGE AND FLUSH-CUT FOR WOOD & METAL



### WOOD&METAL

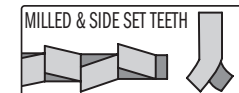

ORDER NO. Universal Arbor	ORDER NO. Arbor for FEIN® SuperCut	Pack Quantity	W inches	I inches	TPI	
<b>OMM10-X1</b>	<b>OMS10-X1</b>	1 in clamshell	7/8	1-7/8	18	<b>10</b>
<b>OMM10-X5</b>	<b>OMS10-X5</b>	5 in clamshell	7/8	1-7/8	18	<b>5</b>
<b>OMM10-X50</b>	<b>OMS10-X50</b>	50 in masterpack	7/8	1-7/8	18	<b>2</b>

## OMM11

Universal Arbor

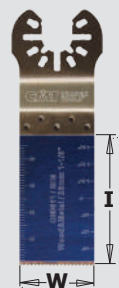

## OMS11

Arbor for  
FEIN® SuperCut  
FESTOOL® VECTURO®



### 1-1/8" PLUNGE AND FLUSH-CUT BLADE FOR WOOD & METAL



### WOOD&METAL

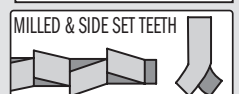

ORDER NO. Universal Arbor	ORDER NO. Arbor for FEIN® SuperCut	Pack Quantity	W inches	I inches	TPI	
<b>OMM11-X1</b>	<b>OMS11-X1</b>	1 in clamshell	1-1/8	1-7/8	18	<b>10</b>
<b>OMM11-X5</b>	<b>OMS11-X5</b>	5 in clamshell	1-1/8	1-7/8	18	<b>5</b>
<b>OMM11-X50</b>	<b>OMS11-X50</b>	50 in masterpack	1-1/8	1-7/8	18	<b>2</b>



# Accessories for Multi-Cutters

## OMM12 OMS12

Universal Arbor



Arbor for  
FEIN® SuperCut  
FESTOOL® VECTURO®



### 1-5/16" PLUNGE AND FLUSH-CUT FOR WOOD & METAL

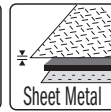

### WOOD&METAL

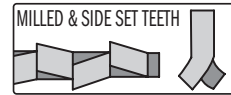

**BIM**  
8% Co

ORDER NO. Universal Arbor	ORDER NO. Arbor for FEIN® Supercut	PACK Quantity	W inches	I inches	TPI	
<b>OMM12-X1</b>	<b>OMS12-X1</b>	1 in clamshell	1-5/16	1-5/8	18	<b>10</b>
<b>OMM12-X5</b>	<b>OMS12-X5</b>	5 in clamshell	1-5/16	1-5/8	18	<b>5</b>
<b>OMM12-X50</b>	<b>OMS12-X50</b>	50 in masterpack	1-5/16	1-5/8	18	<b>2</b>

## OMM13 OMS13

Universal Arbor



Arbor for  
FEIN® SuperCut  
FESTOOL® VECTURO®



### 1-5/16" PLUNGE & FLUSH-CUT BLADE FOR WOOD & METAL

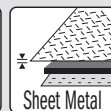

### WOOD&METAL

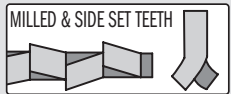

**130%**  
LONGER LIFE

**EXTRA  
LONG  
LIFE**

**BIM  
TiN**

ORDER NO. Universal Arbor	ORDER NO. Arbor for FEIN® Supercut	PACK Quantity	W inches	I inches	TPI	
<b>OMM13-X1</b>	<b>OMS13-X1</b>	1 in clamshell	1-5/16	1-5/8	18	<b>10</b>
<b>OMM13-X5</b>	<b>OMS13-X5</b>	5 in clamshell	1-5/16	1-5/8	18	<b>5</b>
<b>OMM13-X50</b>	<b>OMS13-X50</b>	50 in masterpack	1-5/16	1-5/8	18	<b>2</b>

## OMM14 OMS14

Universal Arbor



Arbor for  
FEIN® SuperCut  
FESTOOL® VECTURO®



### 1-3/8" PLUNGE & FLUSH-CUT BLADE FOR WOOD & METAL

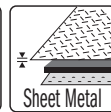

### WOOD&METAL

**CARBIDE  
TIPPED**

**2X**  
LONGER LIFE

**EXTRA  
LONG  
LIFE**

ORDER NO. Universal Arbor	ORDER NO. Arbor for FEIN® Supercut	PACK Quantity	W inches	I inches	TPI	
<b>OMM14-X1</b>	<b>OMS14-X1</b>	1 in clamshell	1-3/8	1-5/8	20	<b>10</b>

## OMM35 OMS35

Universal Arbor



Arbor for  
FEIN® SuperCut  
FESTOOL® VECTURO®



### 1-5/8" PLUNGE AND FLUSH-CUT BLADE FOR WOOD & METAL



### WOOD&METAL

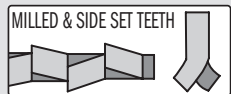

**BIM**  
8% Co

ORDER NO. Universal Arbor	ORDER NO. Arbor for FEIN® Supercut	PACK Quantity	W inches	I inches	TPI	
<b>OMM35-X5</b>	<b>OMS35-X5</b>	5 in clamshell	1-5/8	2-11/16	18	<b>5</b>
<b>OMM35-X50</b>	<b>OMS35-X50</b>	50 in masterpack	1-5/8	2-11/16	18	<b>2</b>

**EXTRA  
LONG**



# Accessories for Multi-Cutters

## OMM15 OMS15

Universal Arbor

Arbor for  
FEIN® SuperCut  
FESTOOL® VECTURO®

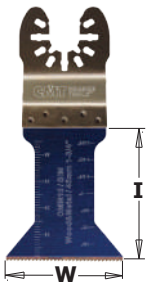

### 1-3/4" PLUNGE AND FLUSH-CUT BLADE FOR WOOD & METAL

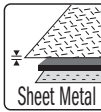

**WOOD&METAL**

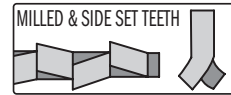

**BIM**  
8% Co



ORDER NO. Universal Arbor	ORDER NO. Arbor for FEIN® SuperCut	Pack Quantity	W inches	I inches	TPI	
<b>OMM15-X1</b>	<b>OMS15-X1</b>	1 in clamshell	1-3/4	1-7/8	18	<b>10</b>
<b>OMM15-X5</b>	<b>OMS15-X5</b>	5 in clamshell	1-3/4	1-7/8	18	<b>5</b>
<b>OMM15-X50</b>	<b>OMS15-X50</b>	50 in masterpack	1-3/4	1-7/8	18	<b>2</b>

## OMM16 OMS16

Universal Arbor

Arbor for  
FEIN® SuperCut  
FESTOOL® VECTURO®



### 1-3/4" PLUNGE & FLUSH-CUT FOR WOOD & METAL

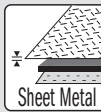

**WOOD&METAL**

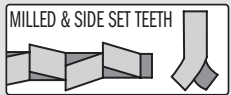

**130%**  
LONGER LIFE

**EXTRA  
LONG  
LIFE**

**BIM  
TiN**



ORDER NO. Universal Arbor	ORDER NO. Arbor for FEIN® SuperCut	Pack Quantity	W inches	I inches	TPI	
<b>OMM16-X1</b>	<b>OMS16-X1</b>	1 in clamshell	1-3/4	1-7/8	18	<b>10</b>
<b>OMM16-X5</b>	<b>OMS16-X5</b>	5 in clamshell	1-3/4	1-7/8	18	<b>5</b>
<b>OMM16-X50</b>	<b>OMS16-X50</b>	50 in masterpack	1-3/4	1-7/8	18	<b>2</b>

## OMM17

Universal Arbor

## OMS17

Arbor for  
FEIN® SuperCut  
FESTOOL® VECTURO®

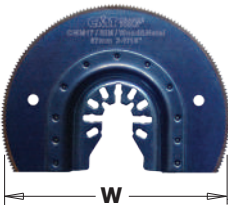

### 3-7/16" RADIAL SAW BLADE FOR WOOD & METAL, SEGMENTED

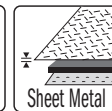
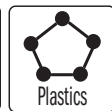

**WOOD&METAL**

**BIM**  
8% Co

**LONG  
LIFE**



ORDER NO. Universal Arbor	ORDER NO. Arbor for FEIN® SuperCut	Pack Quantity	W inches	TPI	
<b>OMM17-X1</b>	<b>OMS17-X1</b>	1 in clamshell	3-7/16	20	<b>10</b>

## OMM18

Universal Arbor

## OMS18

Arbor for  
FEIN® SuperCut  
FESTOOL® VECTURO®

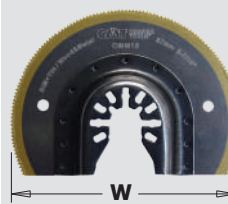

### 3-7/16" RADIAL SAW BLADE FOR WOOD & METAL, SEGMENTED

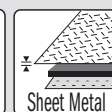
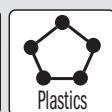

**WOOD&METAL**

**BIM  
TiN**

**130%**  
LONGER LIFE

**EXTRA  
LONG  
LIFE**



ORDER NO. Universal Arbor	ORDER NO. Arbor for FEIN® SuperCut	Pack Quantity	W inches	TPI	
<b>OMM18-X1</b>	<b>OMS18-X1</b>	1 in clamshell	3-7/16	20	<b>10</b>

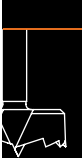
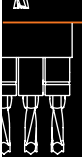
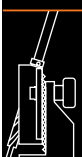

**OMM19 OMS19**

Universal Arbor

Arbor for  
FEIN® SuperCut  
FESTOOL® VECTURO®

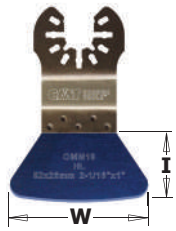

**2-1/16" RIGID SCRAPER FOR ALL MATERIALS**

**MULTI-MAT**



**HL**

ORDER NO. Universal Arbor	ORDER NO. Arbor for FEIN® SuperCut	Pack Quantity	W inches	I inches	
<b>OMM19-X1</b>	<b>OMS19-X1</b>	1 in clamshell	2-1/16	1	<b>10</b>
<b>OMM19-X5</b>	<b>OMS19-X5</b>	5 in clamshell	2-1/16	1	<b>5</b>

**OMM20 OMS20**

Universal Arbor

Arbor for  
FEIN® SuperCut  
FESTOOL® VECTURO®



**2-1/16" FLEXIBLE SCRAPER FOR ALL MATERIALS**

**MULTI-MAT**

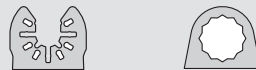

**HL**

ORDER NO. Universal Arbor	ORDER NO. Arbor for FEIN® SuperCut	Pack Quantity	W inches	I inches	
<b>OMM20-X1</b>	<b>OMS20-X1</b>	1 in clamshell	2-1/16	1-3/4	<b>10</b>
<b>OMM20-X5</b>	<b>OMS20-X5</b>	5 in clamshell	2-1/16	1-3/4	<b>5</b>

**OMM21 OMS21**

Universal Arbor

Arbor for  
FEIN® SuperCut  
FESTOOL® VECTURO®



**1-1/8" SHARP CORNER SCRAPER FOR ALL MATERIALS**

**MULTI-MAT**

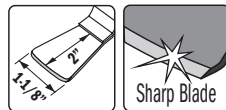

**HL**

ORDER NO. Universal Arbor	ORDER NO. Arbor for FEIN® SuperCut	Pack Quantity	W inches	I inches	
<b>OMM21-X1</b>	<b>OMS21-X1</b>	1 in clamshell	1-1/8	2	<b>10</b>
<b>OMM21-X5</b>	<b>OMS21-X5</b>	5 in clamshell	1-1/8	2	<b>5</b>
<b>OMM21-X50</b>	<b>OMS21-X50</b>	50 in masterpack	1-1/8	2	<b>2</b>

**OMM22 OMS22**

Universal Arbor

Arbor for  
FEIN® SuperCut  
FESTOOL® VECTURO®

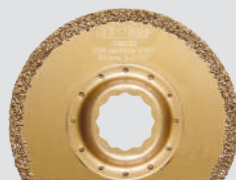

**3-7/16" CARBIDE GRIT RADIAL SAW BLADE, SEGMENTED**

**MASONRY**

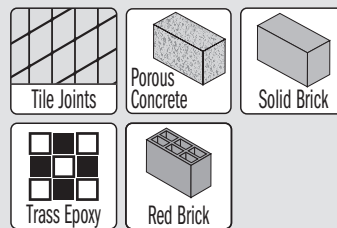

**CARBIDE GRIT**



ORDER NO. Universal Arbor	ORDER NO. Arbor for FEIN® SuperCut	Pack Quantity	W inches	K inches	
<b>OMM22-X1</b>	<b>OMS22-X1</b>	1 in clamshell	3-7/16	5/64	<b>10</b>

**OMM23**

Universal Arbor

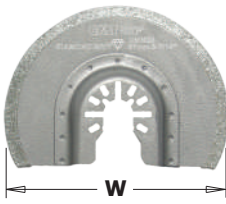

**OMS23**

Arbor for  
FEIN® SuperCut  
FESTOOL® VECTURO®



3-7/16" DIAMOND COATED RADIAL SAW BLADE, SEGMENTED

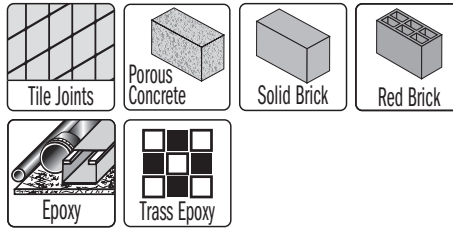

**MASONRY**



ORDER NO. Universal Arbor	ORDER NO. Arbor for FEIN® SuperCut	PACK Quantity	W inches	K inches	
<b>OMM23-X1</b>	<b>OMS23-X1</b>	1 in clamshell	3-7/16	1/16	<b>10</b>
<b>OMM23-X25</b>	<b>OMS23-X25</b>	25 in masterpack	3-7/16	1/16	<b>2</b>

**OMM24**

Universal Arbor

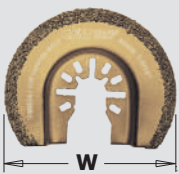

**OMS24**

Arbor for  
FEIN® SuperCut  
FESTOOL® VECTURO®



2-9/16" CARBIDE GRIT RADIAL SAW BLADE, SEGMENTED

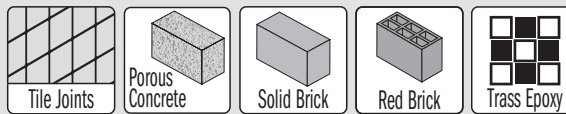

**MASONRY**



ORDER NO. Universal Arbor	ORDER NO. Arbor for FEIN® SuperCut	PACK Quantity	W inches	K inches	
<b>OMM24-X1</b>	<b>OMS24-X1</b>	1 in clamshell	2-9/16	1/16	<b>10</b>

**OMM27**

Universal Arbor



**OMS27**

Arbor for  
FEIN® SuperCut  
FESTOOL® VECTURO®



2-9/16" DIAMOND GRIT COATED RADIAL SAW BLADE, SEGMENTED

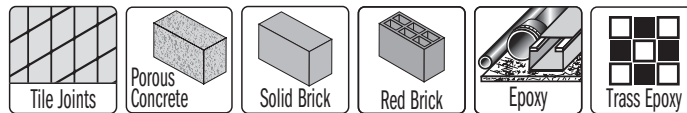

**MASONRY**



ORDER NO. Universal Arbor	ORDER NO. Arbor for FEIN® SuperCut	PACK Quantity	W inches	K inches	
<b>OMM27-X1</b>	<b>OMS27-X1</b>	1 in clamshell	2-9/16	5/64	<b>10</b>

**OMM26**

Universal Arbor



1-3/8" CARBIDE GRIT FINGERTIP RASP - DOUBLE-SIDED

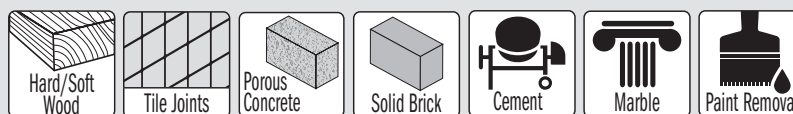

**MASONRY**



ORDER NO. Universal Arbor	PACK Quantity	W inches	I inches	
<b>OMM26-X1</b>	1 in clamshell	1-3/8	1-3/8	<b>10</b>

**OMM25**  
Universal Arbor



**3-1/8" CARBIDE GRIT DELTA RASP**

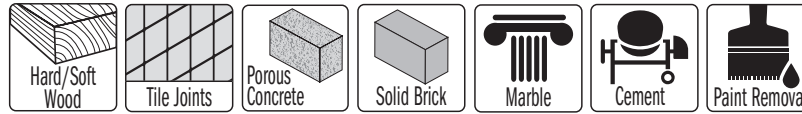

**MASONRY**



ORDER NO. Universal Arbor	Pack Quantity	W inches	
<b>OMM25-X1</b>	1 in clamshell	3-1/8	<b>10</b>

**OMM28**  
Universal Arbor



**2-1/4" DIAMOND COATED SEGMENT SAW BLADE**

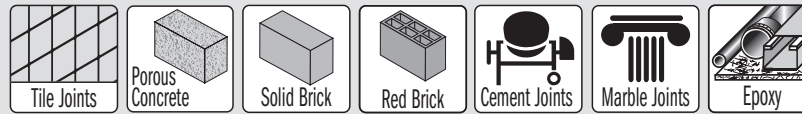

**MASONRY**



ORDER NO. Universal Arbor	Pack Quantity	W inches	K inches	
<b>OMM28-X1</b>	1 in clamshell	2-1/4	5/64	<b>10</b>
<b>OMM28-X25</b>	25 in masterpack	2-1/4	5/64	<b>4</b>

**OMM29**  
Universal Arbor



**OMS29**  
Arbor for  
FEIN® SuperCut  
FESTOOL® VECTURO®



**2-9/16" CARBIDE GRIT GROUT AND MORTAR REMOVER**

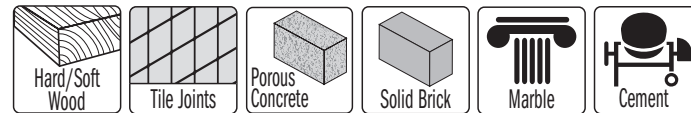

**MASONRY**



ORDER NO. Universal Arbor	ORDER NO. Arbor for FEIN® Supercut	Pack Quantity	W inches	
<b>OMM29-X1</b>	<b>OMS29-X1</b>	1 in clamshell	2-9/16	<b>10</b>

**OMM30**  
Universal Arbor



**OMS30**  
Arbor for  
FEIN® SuperCut  
FESTOOL® VECTURO®



**3-5/8" DELTA SANDING PAD, PERFORATED**

**MULTI-MAT**



ORDER NO. Universal Arbor	ORDER NO. Arbor for FEIN® Supercut	Pack Quantity	W inches	
<b>OMM30-X1</b>	<b>OMS30-X1</b>	1 in clamshell	3-5/8	<b>10</b>

3-5/8" Delta Polishing Fleece. Perforated

SEE PAGE 122

3-5/8" Aluminum-Oxide Delta Sandpaper for Wood. Perforated



**OMA30000**



**OMA30**



# General Purpose Set for Multi-Cutters



## OMM-X4



8 Sets in End-cap display (minimum 8 pieces or multiple)

## OMM-X16



8 Sets in End-cap display (minimum 8 pieces or multiple)

**WOOD**  
**WOOD&NAILS**



OMM-X4		OMM-X16		MATERIAL	W inches	I inches	TPI
ORDER NO. UNIVERSAL ARBOR	Pack Quantity	ORDER NO. UNIVERSAL ARBOR	Pack Quantity				
OMM04-X1	1	OMM04-X1	4	HCS	1-3/8	1-5/8	14
OMM06-X1	1	OMM06-X1	4	HCS	2-11/16	1-5/8	14
OMM12-X1	1	OMM12-X1	4	BIM	1-1/4	1-5/8	18
OMM15-X1	1	OMM15-X1	4	BIM	1-3/4	1-7/8	18

2 blades with Japanese Tothing for cutting wood, chipboard, plasterboard and plastics.

2 blades in BIM for cutting wood products, chipboard, plasterboard, fiberglass, epoxy resins, soft plastics, sheet metal, aluminum pipes and profiles. Cuts through embedded nails in wood up to 5mm in diameter as well as porous concrete.

## OMM-X33

- Blades for cutting wood, plastic, plasterboard, sheet metal, profiles and pipes in aluminum and copper.
- Scraper to remove carpet adhesive/glue residues as well as paint and silicone residues.
- Sanding pad and sanding sheets (60, 100, 180 grit).



ORDER NO. UNIVERSAL ARBOR	Pack Quantity	W inches	I inches	TPI	GRIT
OMM12-X1	1	1-1/4	1-5/8	18	
OMM20-X1	1	2-1/16	1-3/4		
OMM30-X1	1	3-5/8			
OMA30060-X10	10	3-5/8			60
OMA30100-X10	10	3-5/8			100
OMA30180-X10	10	3-5/8			180

6 Sets Masterpack

- Blades (in two diameters) for cutting in wood, plastic, plasterboard, sheet metal, profiles and pipes in aluminum and copper.
- Segmented blade for cutting wood and metal.
- Scraper for removing carpet adhesive/glue residues as well as paint and silicone residues.
- Rasp in carbide for grinding/sanding/removal of tiles, plasterboard, cement, wood and construction materials.
- Specially designed blade to remove mortar, bonding materials, cement and stone, even in hard to reach corners.
- Sanding pad and sanding sheets (60, 100, 180 grit).

ORDER NO. UNIVERSAL ARBOR	Pack Quantity	W inches	I inches	TPI	GRIT
OMM09-X1	1	3/8	1-1/8	18	
OMM12-X1	1	1-1/4	1-5/8	18	
OMM17-X1	1	3-7/16		20	
OMM20-X1	1	2-1/16	1-3/4		
OMM25-X1	1	3-1/8			
OMM29-X1	1	2-9/16			
OMM30-X1	1	3-5/8			
OMA30060-X10	10	3-5/8			60
OMA30100-X10	10	3-5/8			100
OMA30180-X10	10	3-5/8			180

## OMM-X37



4 Sets in End-cap display (minimum 4 pieces or multiple)

# WHAT'S THE SECRET TO FLAWLESS EDGE PROFILES WITH NO REWORK?

**WOOD** MAGAZINE **Best Overall**  
WOOD'S CHOICE FOR ROUTER BITS

**CMT Overall Rating 10!**  
**Top Performing Router Bits**

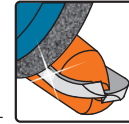

**MULTI-AXIS GRINDING  
 CREATES A 3X LONGER  
 LASTING MIRROR FINISH**

Each cutting edge is precisely sharpened to the micron, in order to produce a cutting angle, which is razor sharp, yet extremely durable.

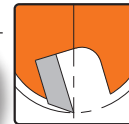

**ANTI-KICKBACK DESIGN**

Controls depth of cut and minimizes the chance of kickback, reducing your risk of injury.



**SINTERHIP  
 HI-DENSITY  
 INDUSTRIAL CHROME  
 CARBIDE**

**SINTERHIP HI-DENSITY  
 INDUSTRIAL CHROME  
 CARBIDE**

New process called SinterHIP (Hot Isostatic Pressing), helps prevent material failure and increases cutting life.

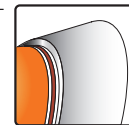

**TRI-METAL BRAZING**

Our Silver-Copper-Silver brazing protects the carbide tip when cutting harder wood or wood composites and reduces the chance of failed welds.



**NON-STICK  
 ORANGE  
 SHIELD  
 COATING**

**NON-STICK  
 ORANGE SHIELD®  
 COATING**

Prevents bit from heating up, reduces pitch build-up, protects against corrosion and provides a longer bit life.











Deluxe packaging



**SUPERIOR  
 HIGH-STRENGTH STEEL**

We use high-quality, solid bar stock sourced from Switzerland, which provides exceptional resistance to fatigue and abrasion.

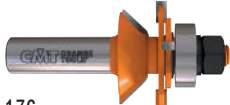
<p><b>UP &amp; DOWN CUT SPIRAL</b></p>  <p>141</p>	<p><b>T2 UPCUT SPIRAL</b></p>  <p>142</p>	<p><b>T2 DOWNCUT SPIRAL</b></p>  <p>142</p>	<p><b>SPIRAL/STRAIGHT SETS</b></p>  <p>143</p>
<p><b>STRAIGHT</b></p>  <p>144-145</p>	<p><b>MORTISING &amp; PLANER</b></p>  <p>146-147</p>	<p><b>PATTERN</b></p>  <p>148</p>	<p><b>PATTERN WITH INSERT KNIVES</b></p>  <p>149</p>
<p><b>WEATHERSEAL</b></p>  <p>150</p>	<p><b>SOLID CARBIDE COMBINATION TRIMMER</b></p>  <p>150</p>	<p><b>COMBINATION TRIMMER</b></p>  <p>151</p>	<p><b>COMBINATION TRIMMER WITH BEARING</b></p>  <p>151-152</p>
<p><b>DP - FLUSH TRIM</b></p>  <p>152</p>	<p><b>FLUSH TRIM</b></p>  <p>152~154</p>	<p><b>SPIRAL FLUSH TRIM</b></p>  <p>155</p>	<p><b>FLUSH TRIM FOR LAMINATE</b></p>  <p>155</p>
<p><b>FLUSH TRIM WITH INSERT KNIVES</b></p>  <p>156</p>	<p><b>PATTERN/FLUSH TRIM</b></p>  <p>157</p>	<p><b>PATTERN/FLUSH TRIM WITH INSERT KNIVES</b></p>  <p>157</p>	<p><b>PANEL PILOT</b></p>  <p>158</p>
<p><b>RABBETING</b></p>  <p>159-161</p>	<p><b>RABBETING WITH INSERT KNIVES</b></p>  <p>159, 161</p>	<p><b>KEYHOLE</b></p>  <p>162</p>	<p><b>T-SLOT</b></p>  <p>162</p>
<p><b>SCREW SLOT</b></p>  <p>163</p>	<p><b>FLOORING</b></p>  <p>163</p>	<p><b>SLOT CUTTERS &amp; SETS</b></p>  <p>164~166</p>	<p><b>FINGER JOINT</b></p>  <p>167</p>
<p><b>FLUTE &amp; BEAD SET</b></p>  <p>168</p>	<p><b>LOCK MITER</b></p>  <p>168-169</p>	<p><b>GLUE JOINT</b></p>  <p>170</p>	<p><b>DRAWER LOCK</b></p>  <p>171</p>
<p><b>OVOLO SASH</b></p>  <p>172</p>	<p><b>WINDOW SASH</b></p>  <p>173</p>		<p><b>DOVETAIL</b></p>  <p>174-175</p>
<p><b>V-TONGUE &amp; GROOVE</b></p>  <p>176</p>		<p><b>EDGE BANDING</b></p>  <p>176</p>	
<p><b>60° LETTERING</b></p>  <p>177</p>	<p><b>BOWL &amp; TRAY</b></p>  <p>177</p>	<p><b>V-GROOVING &amp; LASER POINT</b></p>  <p>178-179</p>	<p><b>V-GROOVING WITH INSERT KNIVES</b></p>  <p>180</p>
<p><b>CHAMFER WITH INSERT KNIVES</b></p>  <p>180</p>	<p><b>CHAMFER</b></p>  <p>181</p>	<p><b>ROUND NOSE</b></p>  <p>182-183</p>	<p><b>BALL END &amp; BALL NOSE SPIRAL BIT</b></p>  <p>183</p>



<b>COVE</b>  184	<b>CAVETTO EDGE MOULD/OVOLO</b>  185	<b>ROUNDROVER &amp; BEADING</b>  186-187	<b>ROUNDROVER WITH INSERT KNIVES</b>  188
<b>CLASSICAL &amp; DECORATIVE BEAD</b>  188-189	<b>OGEE &amp; PROFILES</b>  189-192	<b>ADJUSTABLE ROUNDROVER/BEVEL</b>  193	<b>WAINSCOT/PANELING</b>  194
<b>BEAD &amp; BULL NOSE</b>  195	<b>CORNER BEADING</b>  195	<b>EDGE-FLUTING</b>  196	<b>MOULDING SYSTEM</b>  196
<b>MOULDING &amp; MULTIPROFILE</b>  197-199	<b>FINGER PULL DOOR LIP</b>  198, 200	<b>TABLE EDGE &amp; HAND RAIL</b>  201	
<b>VERTICAL RAISED PANEL</b>  201	<b>RAIL &amp; STILE SET</b>  202-204		<b>RAISED PANEL</b>  205-206
<b>STILE &amp; PANEL</b>  207	<b>STRIPLOX® CUTTER</b>  208	<b>SOLID SURFACE - COUNTER-TOP TRIM</b>  208	<b>SOLID SURFACE - DECORATIVE</b>  209
<b>SOLID SURFACE - ROUNDROVER</b>  209-210	<b>SOLID SURFACE - BEVEL &amp; SLOT</b>  211-212	<b>SOLID SURFACE - CUT &amp; PLUG REPAIR SET</b>  212	<b>SOLID SURFACE - NO-DRIP</b>  213
<b>SOLID SURFACE - WAVY JOINT</b>  213	<b>SOLID SURFACE - DRAINBOARD &amp; INLAY</b>  214	<b>SOLID SURFACE - SINK &amp; TRIM</b>  215	<b>ROUTER BIT SETS</b>  216-237
<b>MORTISING &amp; STRAIGHT</b>  239	<b>PATTERN</b>  239	<b>FLUSH TRIM &amp; LAMINATE</b>  240	<b>PANEL PILOT</b>  240
<b>RABBETING</b>  241	<b>KEYHOLE</b>  241	<b>DOVETAIL</b>  241	<b>CHAMFER</b>  242
<b>V-GROOVE</b>  242	<b>ROUND NOSE</b>  242	<b>COVE &amp; FILLET</b>  243	<b>ROUNDROVER &amp; BEADING</b>  243
<b>BULL NOSE &amp; CONVEX EDGE</b>  244	<b>OVOLO &amp; CORNER BEAD</b>  244-245	<b>OGEE</b>  245-247	<b>ROUTER BIT SETS</b>  248





## Routing Guide

**High-Grade Tungsten Carbide.** If steel is what gives our tools strength, carbide is what gives them intelligence. The capacity of the carbide tip to cut precisely and to last a long time is critical for the performance of any tool, so at CMT we use only premium micrograin carbide from Luxembourg to make the tips for our router bits.

### MANUFACTURING

**Turning, Milling and Cutting.** Our biggest investment in recent years has been in upgrading production. Today, all machinery at CMT is fully automated. CNC machines run by specially trained operators who make sure that the shanks and bodies of our router bits and boring bits are accurate and perfectly balanced.



**Heat Forged Steel Bodies for Large Diameter Bits.** No router bits are exactly the same, sometimes not even in the way they are made. Certain bits require a few more steps than others, like heat forging the steel of larger diameter bits before turning it down into precise bit bodies. This extra step produces a radial grain orientation which gives large diameter bits extra strength and durability.

**Brazing.** We have pioneered the art of brazing. Not only does our unique custom-designed computerized brazing equipment help eliminate the inconsistencies found in old fashioned hand brazing, but our silver-copper-silver brazing 'sandwich' provides a tight bond between the steel and the carbide, with a shock absorbing effect to protect the carbide tips when cutting harder woods.

**Specially Formulated Carbide for Specific Applications.** You have to cut every kind material, so we make sure that our carbide tips can handle each individual job. This means specially formulating the carbide of each tool so that the compositions vary from being super hard (for tough cutting jobs like laminates) to being less

hard (to absorb the impact when cutting large profiles) and everything in between.

**Grinding and Sharpening.** The final step in the production process is no different from the rest: sharpening and grinding are done to extreme precision on multi-axis CNC machines. Each bevel and angle is ground or sharpened to the micron, to produce a cutting edge that is both razor sharp yet extremely durable.



680°C in seconds - and the brazing is complete.

### QUALITY CONTROL

Even the simplest of tasks can include a margin for error. However at CMT, we take measures to prevent this. We always manually check the quality of our tools at each step of the manufacturing process, and we still make test cuts with rail & stile bits to make sure the cut fits. However, now we also use a fully automatic measuring process that evaluates every part of the tool without actually coming into contact with it, to make sure that the tool dimensions are accurate and that the profiles conform precisely to technical specification. We also use this system to gauge the wear and tear on the CNC machines.



CMT's fully automatic measuring system.

# Routing Guide

## CUTTING EDGE TYPE

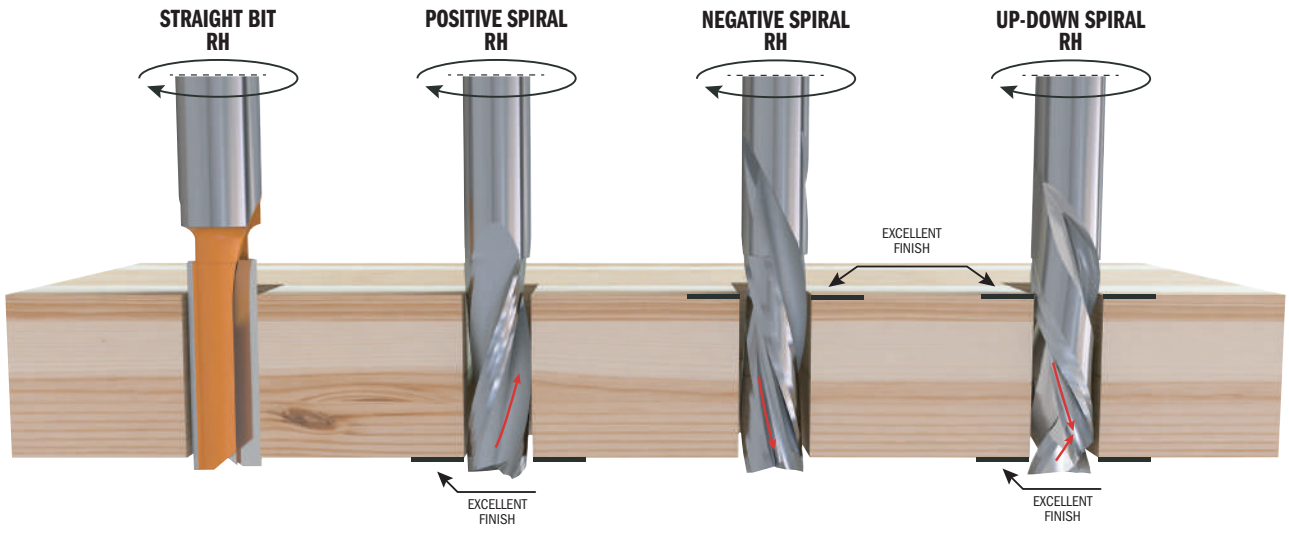

## RECOMMENDED PLUNGING METHOD

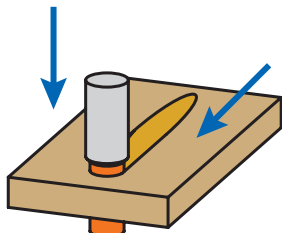

**RAMP PLUNGING**

These methods are recommended for sizing and grooving tools.

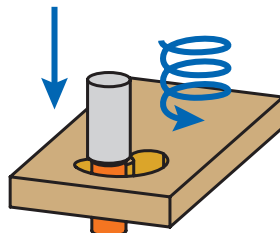

**SPIRAL PLUNGING**

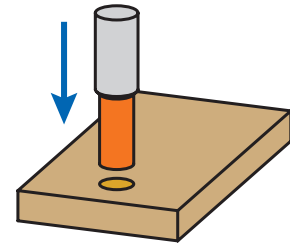

**AXIAL PLUNGING**

Router bits with mainly negative cutting shear angles, negative spiral, and router bits without plunging cutter are **NOT** suitable for axial plunging!

## PROBLEM SOLVING

### PROBLEM

Poor finishing
Cutting edge wear
Cutting edge burns
Cutting edge debris
Vibrations
Cutter breakage

### SOLUTIONS

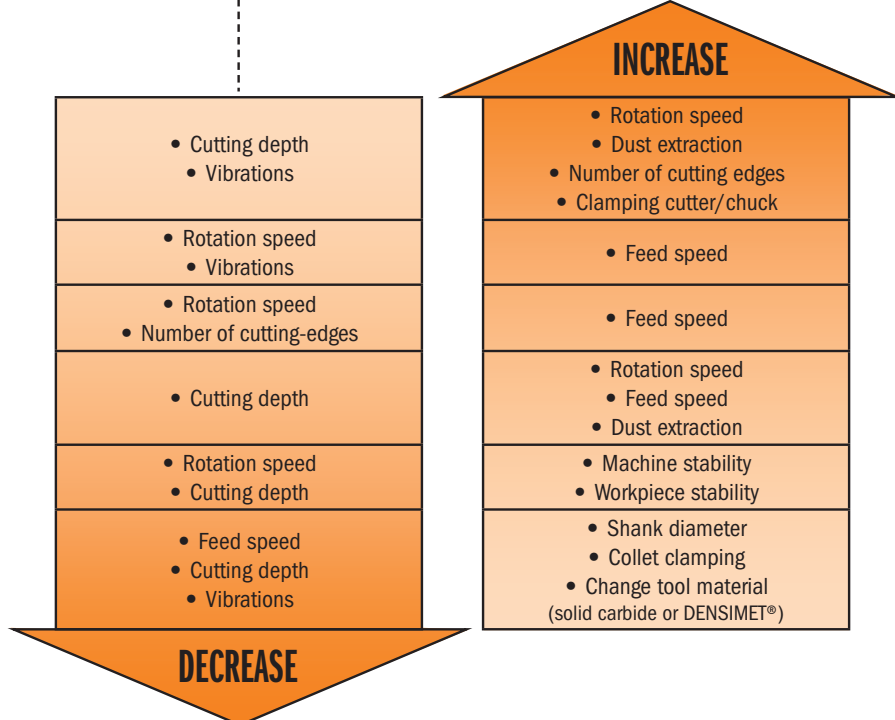



# DLCS Chrome Coating Solid Carbide Upcut & Downcut Spiral Bits



**XTREME PERFORMANCE**

**EXTRA HARD DLCS CHROME COATING**

**3X LONGER LIFE THAN UNCOATED**

**LONG LIFE**

## 190.41 COMPRESSION UPCUT & DOWNCUT 2+2-EDGE



ORDER NO.	Right-hand rotation	Boxes	D inches	D mm	I inches	I Pos. inches	L inches	S inches
190.504.41	10	3/8	9.52	1-1/8	9/32	3	3/8	
190.505.41	10	1/2	12.7	1	15/32	3	1/2	
190.506.41	10	1/2	12.7	1-1/8	15/32	3	1/2	
190.507.41	10	1/2	12.7	1-3/8	15/32	3-1/2	1/2	
190.508.41	10	1/2	12.7	1-5/8	15/32	4	1/2	

## 190.41 COMPRESSION UPCUT & DOWNCUT 3+3-EDGE



ORDER NO.	Right-hand rotation	Boxes	D inches	D mm	I inches	I Pos. inches	L inches	S inches
190.813.41	10	3/8	9.52	1	13/64	3	3/8	
190.815.41	10	1/2	12.7	1-1/8	1/4	3	1/2	

## 190.41 MORTISE COMPRESSION UPCUT & DOWNCUT 2+2-EDGE



ORDER NO.	Right-hand rotation	Boxes	D inches	D mm	I inches	I Pos. inches	L inches	S inches
190.513.41	10	3/8	9.52	7/8	3/16	3	3/8	
190.515.41	10	1/2	12.7	7/8	13/64	3	1/2	
190.517.41	10	1/2	12.7	1-3/8	13/64	3-1/2	1/2	

# Solid Carbide Upcut & Downcut Spiral Bits



## 190 COMPRESSION UPCUT & DOWNCUT 2+2-EDGE



ORDER NO.	Right-hand rotation	Boxes	D inches	D mm	I inches	I Pos. inches	L inches	S inches
190.008.11	10	1/4	6.35	7/8	9/32	2-1/2	1/4	
190.504.11	10	3/8	9.52	1-1/8	9/32	3	3/8	
190.505.11	10	1/2	12.7	1	15/32	3	1/2	
190.506.11	10	1/2	12.7	1-1/8	15/32	3	1/2	
190.507.11	10	1/2	12.7	1-3/8	15/32	3-1/2	1/2	
190.508.11	10	1/2	12.7	1-5/8	15/32	4	1/2	

## 190 COMPRESSION UPCUT & DOWNCUT 3+3-EDGE



ORDER NO.	Right-hand rotation	Boxes	D inches	D mm	I inches	I Pos. inches	L inches	S inches
190.813.11	10	3/8	9.52	1	13/64	3	3/8	
190.815.11	10	1/2	12.7	1-1/8	1/4	3	1/2	

## 190 MORTISE COMPRESSION UPCUT & DOWNCUT 2+2-EDGE



ORDER NO.	Right-hand rotation	Boxes	D inches	D mm	I inches	I Pos. inches	L inches	S inches
190.513.11	10	3/8	9.52	7/8	3/16	3	3/8	
190.515.11	10	1/2	12.7	7/8	13/64	3	1/2	
190.517.11	10	1/2	12.7	1-3/8	13/64	3-1/2	1/2	

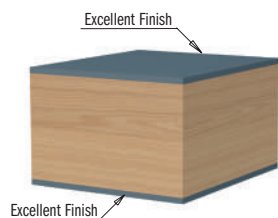

### TECHNICAL DETAILS:

- Premium quality super-micrograin carbide
- 2+2 spiral cutting edges [T2+2].
- 3+3 spiral cutting edges [T3+3].
- Provides excellent finish on both top and bottom sides of the workpiece.

### APPLICATION:

for an excellent edge finish on the top and bottom sides of laminates and double sided melamine. Can also be used with hardwoods and other wood and plastic composites. For fast feed rates on CNC routers, machining centers and point to point machines for ripping, panel sizing, template routing and other routing applications.



# Solid Carbide Upcut 2-Edge Spiral Bits



**191**



ORDER NO. Right-hand rotation		D		I inches	L inches	S inches
		inches	mm			
191.001.11	10	1/8	3.18	1/2	2	1/4
191.003.11	10	5/32	3.97	1/2	2	1/4
191.005.11	10	3/16	4.76	3/4	2	1/4
191.007.11	10	1/4	6.35	3/4	2	1/4
191.008.11	10	1/4	6.35	1	2-1/2	1/4
191.501.11	10	5/16	7.94	1	3	1/2
191.503.11	10	3/8	9.52	1-1/4	3-1/4	1/2
191.505.11	10	1/2	12.7	1-1/4	3	1/2
191.506.11	10	1/2	12.7	1-1/2	3-1/2	1/2
191.507.11	10	1/2	12.7	2	4	1/2

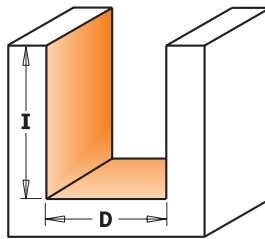

Drawing is 1:1 scale

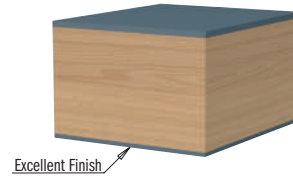

# Solid Carbide Downcut 2-Edge Spiral Bits



**192**



ORDER NO. Right-hand rotation		D		I inches	L inches	S inches
		inches	mm			
192.001.11	10	1/8	3.18	1/2	2	1/4
192.003.11	10	5/32	3.97	1/2	2	1/4
192.005.11	10	3/16	4.76	3/4	2	1/4
192.007.11	10	1/4	6.35	3/4	2	1/4
192.008.11	10	1/4	6.35	1	2-1/2	1/4
192.501.11	10	5/16	7.94	1	3	1/2
192.503.11	10	3/8	9.52	1-1/4	3-1/4	1/2
192.505.11	10	1/2	12.7	1-1/4	3	1/2
192.506.11	10	1/2	12.7	1-1/2	3-1/2	1/2
192.507.11	10	1/2	12.7	2	4	1/2

10 PCS. IN MASTERPACK

192.008.11-X10		1/4	6.35	1	2-1/2	1/4
192.501.11-X10		5/16	7.94	1	3	1/2
192.505.11-X10		1/2	12.7	1-1/4	3	1/2

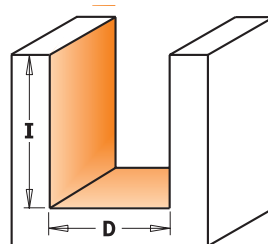

Drawing is 1:1 scale



**X10** (10 PCS. IN MASTERPACK)

## 5-piece Solid Carbide Spiral Bit Sets



Our most popular solid carbide Spiral Bits at your fingertips in a safe, economical package! Choose upcut or downcut sets, each including 3/16", 1/4", 5/16", 3/8" and 1/2" diameters. Ideal for use on all soft/hard woods, plywood, laminates, MDF and plastic materials, with a CNC or handheld router. Remember: **upcut** bits provide fast chip ejection and deliver the finest finish on the lower surface of the workpiece. **Downcut** bits are the best choice where an ultra-smooth finish on the upper surface is the highest priority.

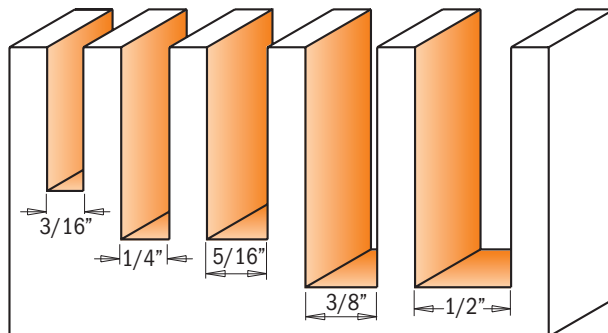
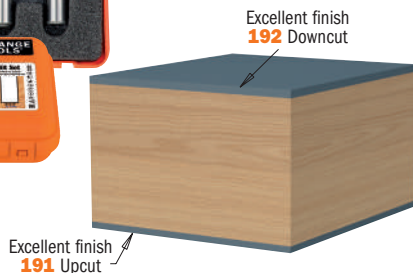

Drawing is 1:1 scale

### 191.000.02 UPCUT 2-EDGE SPIRAL BITS



ORDER NO.	ORDER NO.	D	I	L	S
S=01/4" shank	S=01/2" shank	inches	mm	inches	inches
191.005.11		3/16	4.76	3/4	2
191.008.11		1/4	6.35	1	2-1/2
	191.501.11	5/16	7.94	1	3
	191.503.11	3/8	9.52	1-1/4	3
	191.505.11	1/2	12.7	1-1/4	3

### 192.000.02 DOWNCUT 2-EDGE SPIRAL BITS



ORDER NO.	ORDER NO.	D	I	L	S
S=01/4" shank	S=01/2" shank	inches	mm	inches	inches
192.005.11		3/16	4.76	3/4	2
192.008.11		1/4	6.35	1	2-1/2
	192.501.11	5/16	7.94	1	3
	192.503.11	3/8	9.52	1-1/4	3
	192.505.11	1/2	12.7	1-1/4	3

## 3-piece Plywood Groove Sets



These groove bits are specifically designed to rout grooves and dadoes for joints in plywood. This means they match the true thickness of the material, producing tight, accurate joints. Use our 23/32" bit for 3/4" plywood, 31/64" bit for 1/2" plywood and our 15/64" bit for 1/4" plywood. No gaps. No sloppy joints. No worries! These money-saving 3-bit sets are available with 1/2" or 1/4" shanks.

### EXAMPLE SHOWN IN 1/2" THICK PLYWOOD

This joint is made with the CMT 31/64" straight bit in 1/2" plywood. Notice the precise fit - no gaps.



This joint is made with a regular 1/2" straight bit in 1/2" plywood. Notice the extra space and ill fitting joint.

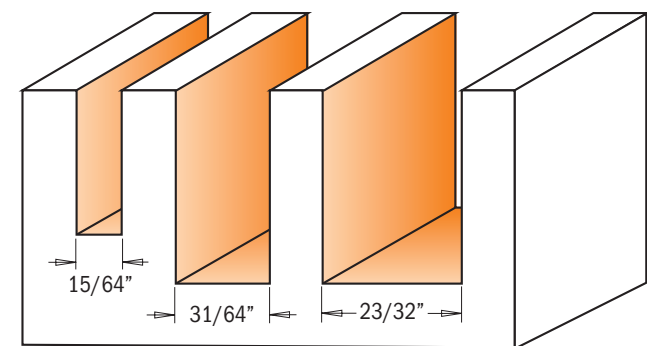

Drawing is 1:1 scale

### 811.001.11

1/4" Shank

SET CONTAINS	ORDER NO.	D	I
	S=01/4" shank	inches	mm
Straight bit	• 811.060.11	15/64	6
Straight bit	811.123.11	31/64	12.3
Straight bit	811.182.11	23/32	18.2

### 811.501.11

1/2" Shank

SET CONTAINS	ORDER NO.	D	I
	S=01/2" shank	inches	mm
Straight bit	• 811.560.11	15/64	6
Straight bit	811.623.11	31/64	12.3
Straight bit	811.682.11	23/32	18.2

• Solid Carbide

# Straight Bit Short Series



SOLID CARBIDE CARBIDE TIPPED T1 T2 RH

## 811

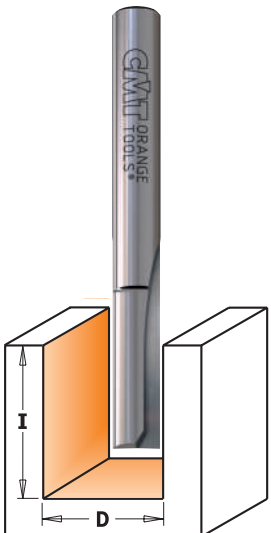

Drawing is 1:1 scale

• Solid Carbide  
\*T1

ORDER NO. S=01/4" shank	ORDER NO. S=01/2" shank		D		I	L	APPLICATION
			inches	mm	inches	inches	
• 811.020.11*		10		2	5/32	1-3/4	
• 811.030.11		10		3	5/16	1-3/4	
• 811.032.11		10	1/8	3.2	3/8	1-3/4	
• 811.040.11		10	5/32	4	3/8	1-3/4	Bit for biscuits
• 811.047.11		10	3/16	4.75	1/2	2	
• 811.050.11		10		5	15/32	2	
• 811.060.11		10	15/64	6	5/8	2	Ply-Groove Bit
	• 811.560.11	10	15/64	6	3/4	2-1/2	Ply-Groove Bit
• 811.064.11		10	1/4	6.35	3/4	2	
• 811.065.11		10	1/4	6.35	3/4	2-1/4	For Inkra Jig
	• 811.564.11	10	1/4	6.35	3/4	2-1/2	For Inkra Jig
• 811.070.11		10		7	23/32	1-7/8	
• 811.080.11		10	5/16	7.94	3/4	2	
• 811.081.11		10	5/16	7.94	1	2-3/4	For Leigh Jig
	• 811.581.11	10	5/16	7.94	1	2-3/4	For Inkra Jig
811.095.11		10	3/8	9.52	3/4	2	
811.096.11		10	3/8	9.52	1	2-1/2	For Inkra Jig
	811.595.11	10	3/8	9.52	1	2-5/8	For Inkra Jig
811.100.11		10		10	3/4	1-7/8	
	811.600.11	10		10	1	2-1/2	
811.120.11		10		12	3/4	2	
	811.620.11	10		12	1	2-1/2	
811.123.11		10	31/64	12.3	1	2-1/4	Ply-Groove Bit
	811.623.11	10	31/64	12.3	1	2-1/2	Ply-Groove Bit
811.127.11		10	1/2	12.7	3/4	2-1/4	
	811.627.11	10	1/2	12.7	1	2-5/8	
	811.628.11	10	1/2	12.7	1-1/4	3-1/4	For Leigh Jig
811.140.11		10		14	3/4	2	
811.142.11		10	9/16	14.2	9/16	2-1/4	
811.150.11		10		15	3/4	2-1/4	
811.158.11		10	5/8	15.87	3/4	2-5/8	
	811.660.11	10	5/8	15.87	1	2-1/2	
811.160.11		10		16	3/4	2-1/4	
	811.661.11	10		16	1	2-1/2	
811.180.11		10		18	3/4	2	
811.182.11		10	23/32	18.2	1	2-1/4	Ply-Groove Bit
	811.682.11	10	23/32	18.2	1	2-1/2	Ply-Groove Bit
811.191.11		10	3/4	19.05	3/4	2-1/4	
	811.690.11	10	3/4	19.05	1	2-1/2	
	811.700.11	10	25/32	19.85	1	2-5/16	
811.200.11		10		20	3/4	2	
811.220.11		10		22	3/4	2-1/4	
811.254.11		10	1	25.4	3/4	2	
	811.754.11	10	1	25.4	1-1/4	3	
	811.785.11	10	1-1/8	28.57	1-1/4	3	

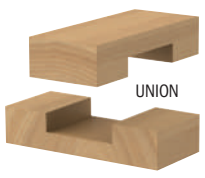
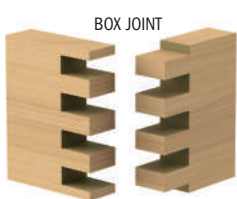

# Straight Bits, Long Series

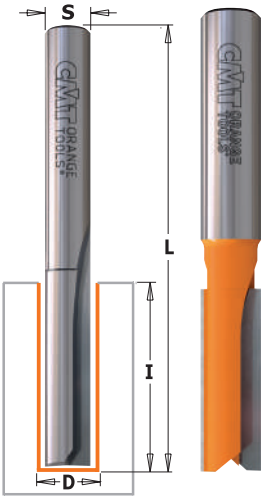

T3 for Nesting

## 812

CMT's Straight Bits offer an array of features that define our top-quality tools: razor-sharp edges, special high-strength steel and the finest micrograin carbide. Built to withstand even the heaviest working conditions, CMT bits will continue to provide smooth, precise cuts everytime. Count on exceptional chip ejection for cleaner, more constant cutting. These bits feature our trademark orange P.T.F.E. Industrial Coating to guard against resin, pitch and other residue build-up. A variety of Straight Bits to choose from guarantees production at an industrial scale on a variety of materials like plywood, composites and natural woods.



**SAFETY PRECAUTIONS:** never use damaged or worn bits. Always work at the recommended proper feed rate without forcing the bit. Pay particular attention when making the initial cut with a small diameter bit. For best results when working with small diameter bits, make the cut in more than one pass.

The sharpened cutting edge is perfect for short plunging operations

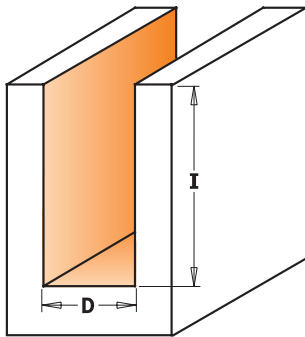

Drawing is 1:1 scale



X10 (10 PCS. IN MASTERPACK)

ORDER NO. S=Ø1/4" shank	ORDER NO. S=Ø1/2" shank		D		I	L	APPLICATION
			inches	mm	inches	inches	
• 812.032.11		10	1/8	3.2	1/2	2	
• 812.060.11		10	15/64	6	1	2-3/8	
• 812.064.11		10	1/4	6.35	1	2-3/8	
• 812.080.11		10	5/16	7.94	1-1/4	2-3/8	
812.095.11		10	3/8	9.52	1-1/4	2-1/2	
	812.595.11	10	3/8	9.52	1-1/4	2-7/8	
812.100.11		10		10	1-1/4	2-3/8	
	812.600.11	10		10	1-1/4	2-3/4	
	812.611.11	10	7/16	11.1	1-1/4	3-1/4	For Leigh Jig
812.120.11		10		12	1-1/4	2-3/8	
	812.620.11	10		12	1-1/4	2-3/4	
	812.621.11	10		12	1-1/2	3-3/4	
812.127.11		10	1/2	12.7	1-1/4	2-3/4	
	812.627.11	10	1/2	12.7	1-1/2	3-3/4	
	812.628.11	10	1/2	12.7	2	4-1/4	
	812.629.11	10	1/2	12.7	2-1/2	4-3/8	
812.140.11		10		14	1-1/4	2-3/8	
812.150.11		10		15	1-1/4	2-5/8	
812.158.11		10	5/8	15.87	1-1/4	2-3/4	
812.160.11		10		16	1-1/4	2-5/8	
	812.660.11	10		16	1-1/4	2-3/4	
	812.690.11	10	3/4	19.05	1-1/2	3-1/4	
	812.691.11	10	3/4	19.05	2	3-5/8	
10 PCS. IN MASTERPACK							
812.064.11-X10			1/4	6.35	1	2-3/8	
	812.627.11-X10		1/2	12.7	1-1/2	3-3/4	
	812.628.11-X10		1/2	12.7	2	4-1/4	
FOR INDUSTRIAL NESTING APPLICATION [T3] - DLCS CHROME LONG-LIFE COATING							
T3 812.564.11	• 812.564.11	10	1/4	6.35	1	2-7/8	For Nesting
812.581.11	• 812.581.11	10	5/16	7.94	1-1/8	3	For Nesting

### • Solid Carbide

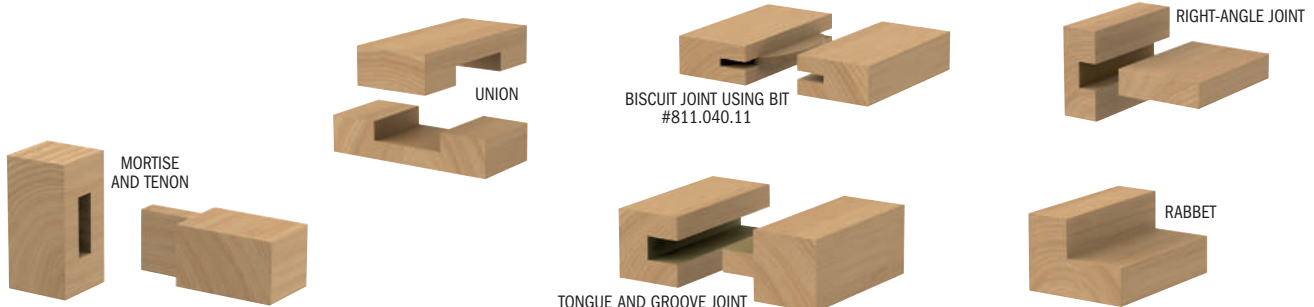



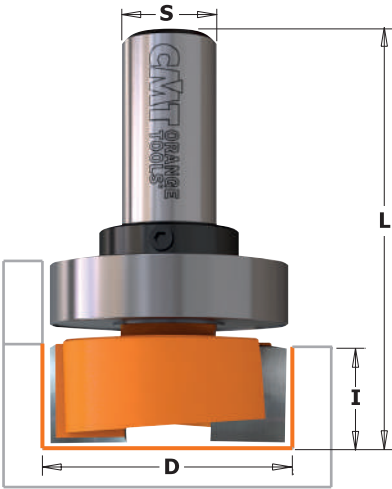

## 801B

Perfectly mortised hinges are the sign of a true artisan. These bits equipped with thick Tungsten carbide tips and negative shear angle design, guarantee flawless performance. Mortise perfect hinges with no splintered edges or rough bottoms. Mortising is a breeze on both natural wood and wood composites. Compatible with most mortising jigs. Complete with a top bearing guide, these bits are the perfect tool for sign making and template work.



The CMT mortising bit is an essential tool for traditional hinge installation.

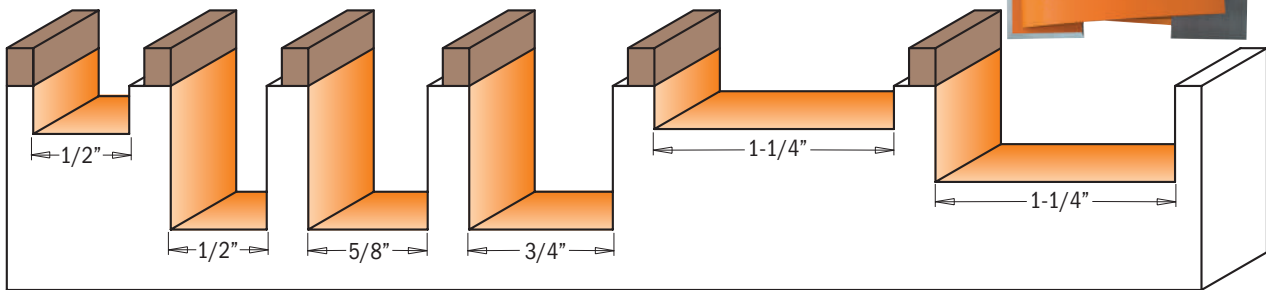

Drawing is 1:1 scale

ORDER NO. S=Ø1/4" shank	ORDER NO. S=Ø1/2" shank		D		I	L
			inches	mm	inches	inches
801.128.11		10	1/2	12.7	1/4	1-5/8
801.127.11		10	1/2	12.7	3/4	2-1/8
	801.627.11	10	1/2	12.7	3/4	2-3/8
801.158.11		10	5/8	15.87	3/4	2-1/4
801.190.11		10	3/4	19.05	3/4	2-1/8
	801.690.11	10	3/4	19.05	3/4	2-1/4
	801.818.11	10	1-1/4	31.7	7/32	2-31/64
801.317.11		10	1-1/4	31.7	1/2	1-57/64
	801.817.11	10	1-1/4	31.7	1/2	2-1/8
WITH TOP BEARING						
801.128.11B*		10	1/2	12.7	1/4	1-5/8
801.127.11B		10	1/2	12.7	3/4	2-1/8
801.158.11B		10	5/8	15.87	3/4	2-1/4
801.190.11B		10	3/4	19.05	3/4	2-1/8
	801.818.11B	10	1-1/4	31.7	7/32	2-31/64
	801.817.11B	10	1-1/4	31.7	1/2	2-1/8

Spare parts		
791.010.00	541.001.00	991.056.00
791.010.00	541.001.00	991.056.00
791.009.00	541.001.00	991.056.00
791.004.00	541.001.00	991.056.00
791.015.00	541.002.00	991.056.00
791.015.00	541.002.00	991.056.00

\*Bit designed for Dado clean-out. For use on flooring medallions.

# Dado & Planer Bits



**852B**

**852**

This bit is perfect for smoothing baseboard and rough surfaces. Tungsten carbide tips and downward shear angle provide exceptional performance and quality. This bit can be used to remove paint and enamel residues. Also available with bearing for projects requiring high precision.

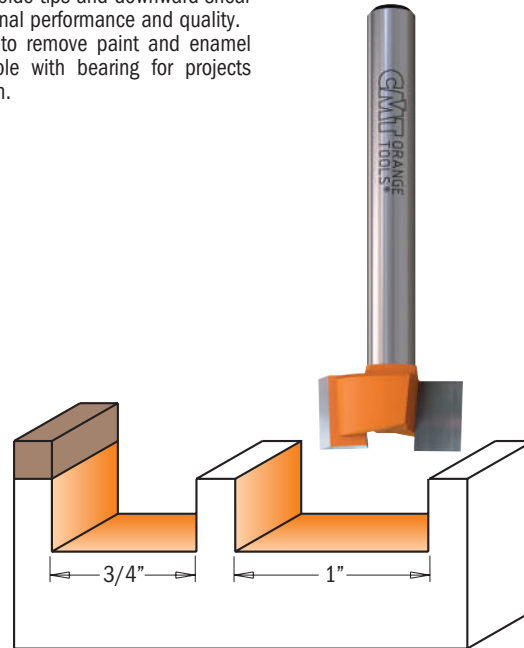

Drawing is 1:1 scale

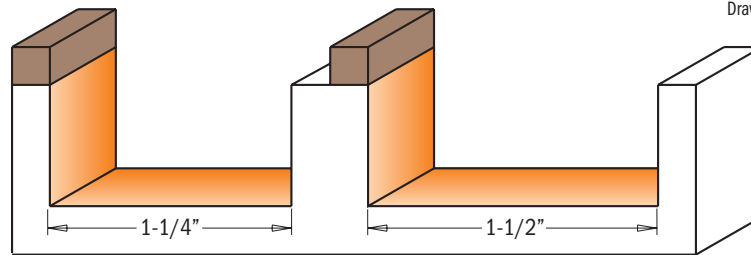

ORDER NO. S=01/4" shank	ORDER NO. S=01/2" shank		D		I	L
			inches	mm	inches	inches
<b>852.001.11</b>		10	3/4	19.05	3/8	2-1/4
	<b>852.501.11</b>	10	3/4	19.05	3/8	2-1/2
	<b>852.502.11</b>	10	1	25.4	3/8	2-1/4
	<b>852.503.11</b>	10	1-1/4	31.7	5/8	2-3/4
	<b>852.504.11</b>	10	1-1/2	38.1	5/8	2-3/4
WITH TOP BEARING						
<b>852.001.11B</b>		10	3/4	19.05	3/8	2-1/4
	<b>852.501.11B</b>	10	3/4	19.05	3/8	2-1/2
	<b>852.503.11B</b>	10	1-1/4	31.7	5/8	2-3/4
	<b>852.504.11B</b>	10	1-1/2	38.1	5/8	2-3/4

*Spare parts*

791.004.00	541.001.00	991.056.00
791.011.00	541.002.00	991.056.00
791.015.00	541.002.00	991.056.00
791.020.00	541.002.00	991.056.00

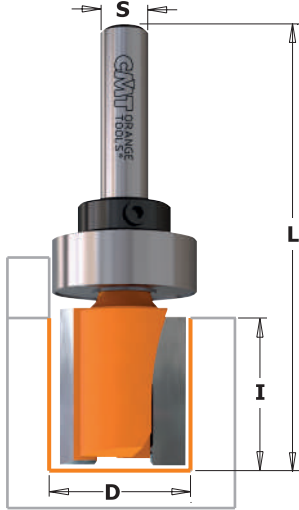

**811B**

These double-fluted bits paired with the template of your choice will produce distinctive cabinets, furniture pieces, signs, toys and personalize a variety of creative projects.

**SAFETY TIPS:** make sure your router is in top condition. The template must be securely fastened to the workpiece. When choosing a bit, carefully consider the thickness of the template and all the implications of the cut. Opt for the shortest bit possible for the project you are working on.

**812B**

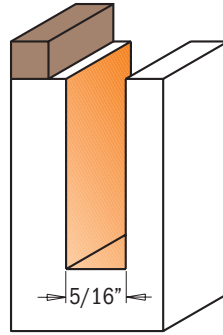

811.081.11B

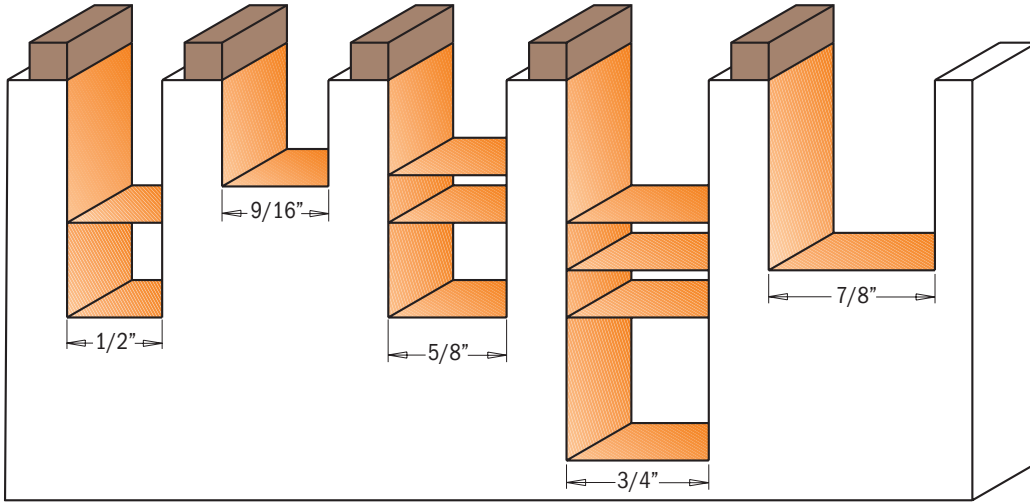

Drawing is 1:1 scale

ORDER NO. S=Ø1/4" shank	ORDER NO. S=Ø1/2" shank		D		I	L
			inches	mm	inches	inches
811.081.11B ■		10	5/16	7.94	1	2-3/4
811.127.11B		10	1/2	12.7	3/4	2-1/4
811.142.11B ■		10	9/16	14.2	9/16	2-1/4
811.159.11B		10	5/8	15.87	1/2	2-9/32
811.158.11B		10	5/8	15.87	3/4	2-5/8
811.191.11B		10	3/4	19	3/4	2-1/4
	811.690.11B	10	3/4	19	1	2-1/2
	811.222.11B*	10	7/8	22.2	1	2-5/8
812.127.11B		10	1/2	12.7	1-1/4	2-3/4
812.158.11B		10	5/8	15.87	1-1/4	2-3/4
	812.690.11B	10	3/4	19.05	1-1/2	3-1/4
	812.691.11B	10	3/4	19.05	2	3-5/8

Spare parts

791.010.00	541.001.00	991.056.00
791.010.00	541.001.00	991.056.00
791.009.00	541.001.00	991.056.00
791.009.00	541.001.00	991.056.00
791.009.00	541.001.00	991.056.00
791.004.00	541.001.00	991.056.00
791.011.00	541.002.00	991.056.00
791.021.00	541.006.00	991.056.00
791.010.00	541.001.00	991.056.00
791.009.00	541.001.00	991.056.00
791.011.00	541.002.00	991.056.00
791.011.00	541.002.00	991.056.00

■ Item with larger diameter bearing

\*Ø3/8" shanks with Ø3/8"-1/2" bushings (799.001.00)

# Pattern Router Bits with Insert Knives

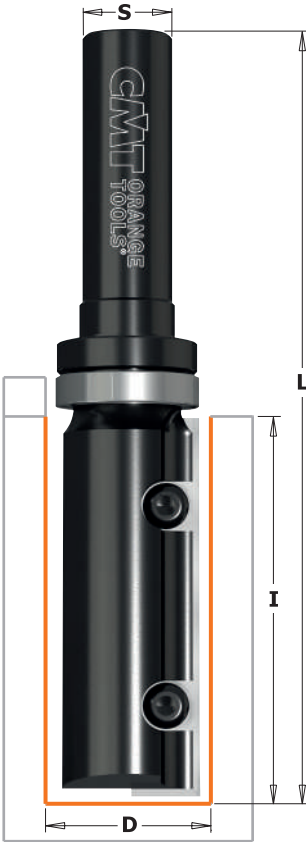

## 652B

Straight router bits with a replaceable knife fixed by a TORX® screw. An economical solution for specialized applications requiring low downtime. Cut up to 40mm in depth by carrying out several passes. Equipped with top bearing for template use. For routing, trimming and grooving in board materials (laminated chipboards, MDF) and hardwood. For use on portable routers.

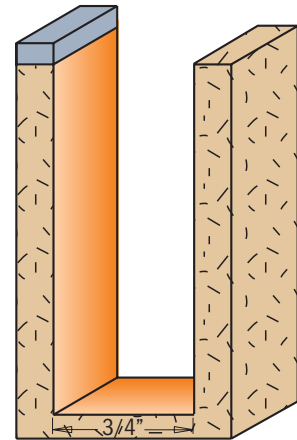
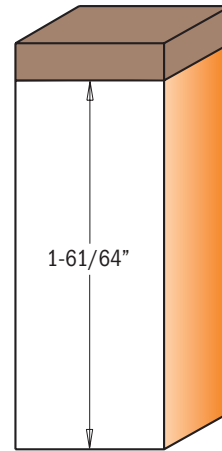
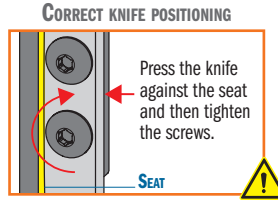
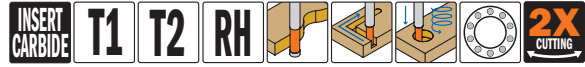

Drawing is 1:1 scale

### SAFETY TIPS:



The **TW-006** Torque Screwdriver is recommended for the proper fastening of screws (see page 267).

- 652.691.11B** [T1]
- 652.787.11B** [T2]

ORDER NO.		D		I	L
S=Ø1/2" shank		inches	mm	inches	inches
<b>652.691.11B</b>	10	3/4	19.05	1-61/64	3-61/64
<b>652.787.11B</b>	10	1-1/8	28.6	1-61/64	3-61/64

Spare parts: **541.002.00** Ø1/2" stop collar  
**991.056.00** 1.5mm hex key

### Spare parts

790.495.09	990.072.00	991.061.00	791.011.00
790.503.00*	990.076.00	991.061.00	791.027.00

\* 3 bore

# Pattern Router Bits with Insert Knives for Laminates



## 656

Straight router bits with a replaceable knife fixed by a TORX® screw. The top knife features a 3° sharpened angle for plunge and high precision cuts. Equipped with top bearing for template use. For finishing, routing and grooving in board materials (laminated chipboards, MDF) and hardwood. For use on portable routers.

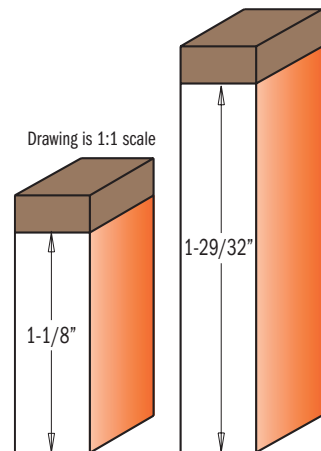
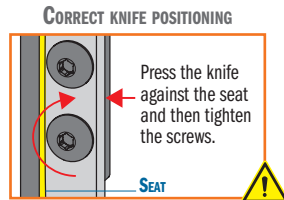
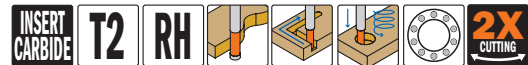

Drawing is 1:1 scale

### SAFETY TIPS:



The **TW-006** Torque Screwdriver is recommended for the proper fastening of screws (see page 267).

ORDER NO.		D		I	L
S=Ø1/2" shank		inches	mm	inches	inches
<b>656.691.11</b>	10	3/4	19.05	1-1/8	3-1/8
<b>656.693.11</b>	10	3/4	19.05	1-29/32	3-15/16

Spare parts: **541.002.00** Ø1/2" stop collar  
**991.056.00** 1.5mm hex key

### Spare parts

790.283.12	990.075.00	991.061.00	791.011.00
790.483.12	990.075.00	991.061.00	791.011.00



**Weatherseal Bits**

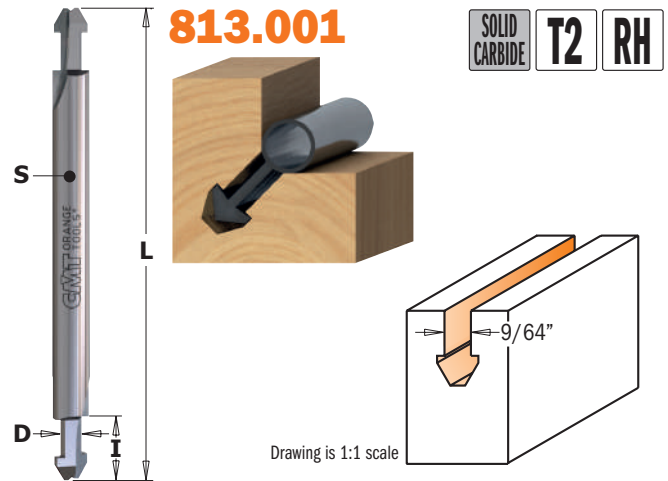
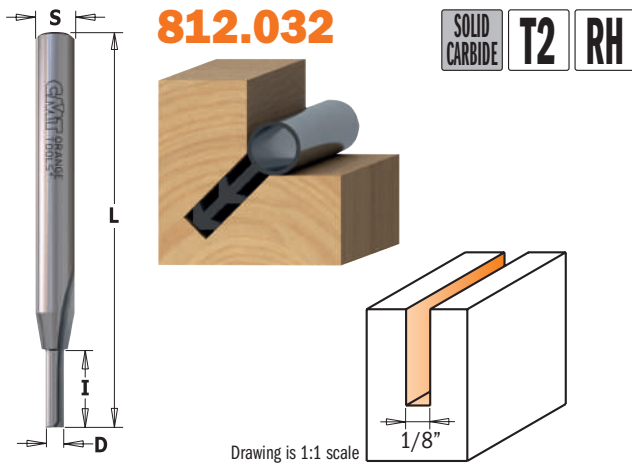

Make your house more energy efficient by insulating old doors and windows. The CMT Weatherseal bit is the perfect bit to re-groove door and window frames to accommodate wind blocking inserts. Made of solid tungsten carbide for strength and endurance, these bits reach up to 12mm in depth without the risk of breakage.

Special double-sided design lets you save money by offering two tips in one bit; with the same features as the one-sided weatherseal bit. Only available with a 1/8" cutting diameter.

ORDER NO.		D	I	L
S=Ø1/4" shank		inches	mm	inches
<b>812.032.11</b>	<b>10</b>	1/8	3.2	1/2

ORDER NO.		D	I	L
S=Ø1/4" shank		inches	mm	inches
<b>813.001.11</b>	<b>10</b>	9/64	3.5	5/16

**Solid Carbide Combination Trimmer Bits**

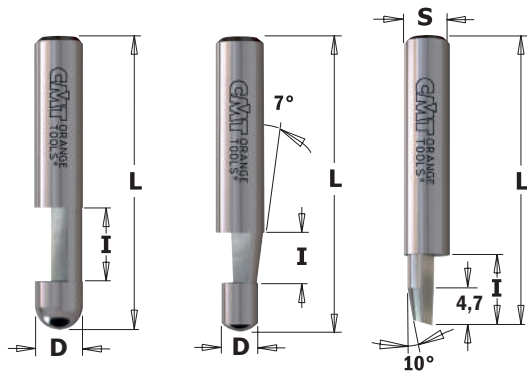

**842 - 843**

Work to your highest standards with CMT combination trimmer bits. Now you can cut, trim and bevel all laminates without having to change the bit. Achieve great results when making straight or angled cuts on both soft and hardwood. Three popular sizes, each with carbide-tipped edges, guarantee efficient bevels and straight trimming (7° or combined 0°-10°).

**NOTICE:** to be used with an edge, separate guide or fence.

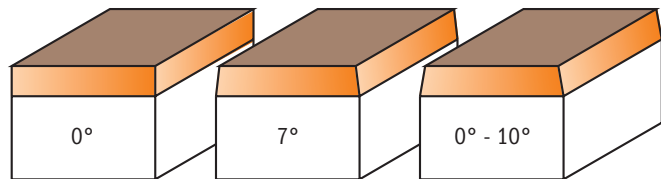

ORDER NO.		A	D	I	L
S=Ø1/4" shank			inches	mm	inches
<b>842.095.11</b>	<b>10</b>	0°	1/4	6.35	3/8
<b>843.063.11</b>	<b>10</b>	7°	1/4	6.35	1/4
<b>843.064.11</b>	<b>10</b>	0° - 10°	1/4	6.35	3/8
<b>50 PCS. IN MASTERPACK</b>					
<b>842.095.11-X50</b>		0°	1/4	6.35	3/8
<b>843.063.11-X50</b>		7°	1/4	6.35	1/4



# Combination Trimmer Bits

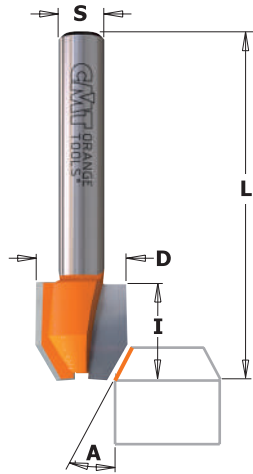

## 821



Work to your highest standards with the CMT combination trimmer bits. Now you can cut, trim and bevel all laminates without having to change the bit. Achieve great results when making straight or angled cuts on both soft and hardwood. Three popular sizes, each with carbide-tipped cutting edges for efficient bevel and straight trimming.

**NOTICE:** to be used with an edge, separate guide or fence.

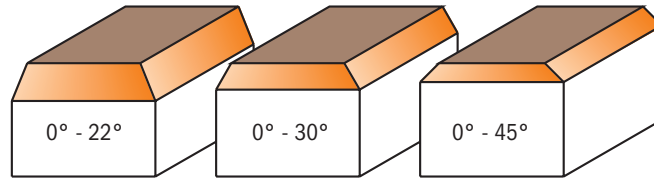

Drawing is 1:1 scale

ORDER NO.		A	D		I	L
S=01/4" shank			inches	mm	inches	inches
821.022.11	10	0° - 22°	15/32	11.9	1/2	1-3/4
821.030.11	10	0° - 30°	15/32	11.9	1/2	1-3/4
821.045.11	10	0° - 45°	15/32	11.9	1/2	1-3/4

# Combination Trimmer Bits

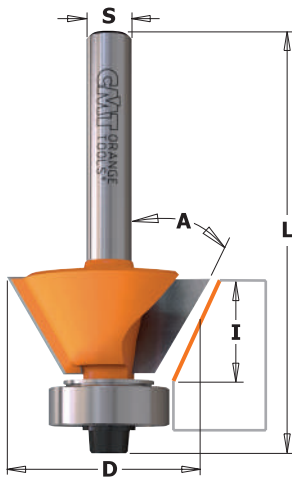

## 809



CMT Bevel trim bits are ideal for putting a superior finish on laminates. They feature two flutes for smoother cutting and specially coated bearings to protect your work piece. The cutting depth of the bit can be varied to obtain precise borders and edges on both soft and hard woods.

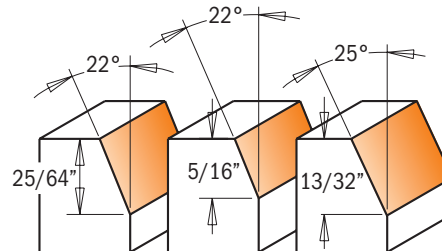

Drawing is 1:1 scale

**809.022.11**  
**809.025.11**

ORDER NO.		A	D		I	L	T
S=01/4" shank			inches	mm	inches	inches	
809.022.11	10	22°	1/2	12.7	5/16	1-7/8	2
809.023.11	10	22°	11/16	17.5	3/8	2	3
809.025.11	10	25°	3/4	19.05	13/32	2-1/16	2

### Spare parts

791.035.00	990.062.00	991.060.00	
990.422.00	791.002.00	990.058.00	991.057.00
990.422.00	791.002.00	990.058.00	991.057.00

# Non-Blocking Combination Trimmer Bit

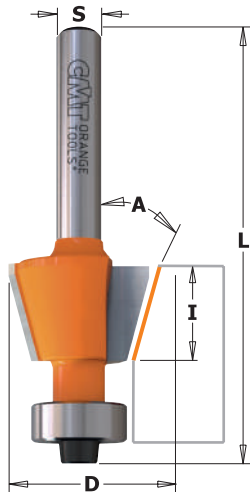

## 809



Ideal bit for efficient trimming of laminates, chipboard and melamine. The bit is equipped with a DELRIN® bearing to match the workpiece without scratching or marring. The gap between the bearing and the bottom of the cutter allows for an efficient ejection of glue and resin without blocking the bearing, so your tool will last longer and remain in top condition!

**NON  
BLOCKING**

DELRIN® anti-stick properties greatly reduce the likelihood of freezing from glue and prevent scratching, unlike the traditional steel bearing.

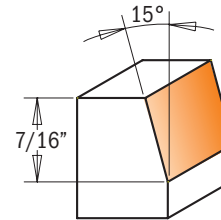

Drawing is 1:1 scale

ORDER NO.		A	D		I	L
S=Ø1/4" shank			inches	mm	inches	inches
809.016.11	10	15°	47/64	18.6	7/16	2-1/4

### Spare parts

990.422.00	791.044.00	990.058.00	991.057.00

# DP - Flush Trim Bits for Laminates



## 806 XTREME



These new super duty DP (polycrystalline diamond) bits represent the ultimate in the extensive line of CMT flush trim bits. Investing in CMT DP flush trim bits means saving time and money as they last 40 times longer than conventional carbide-tipped flush trim bits.

**SHOP TIPS:** after resharpening, replace bearing 791.003.11 (Ø12.7mm) with undersized bearing 791.063.00 (Ø12.5mm)

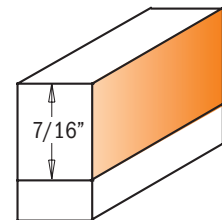
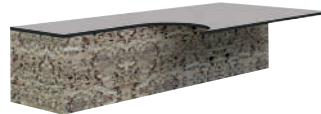

Drawing is 1:1 scale

ORDER NO.		I	D	L
S=Ø1/4" shank		inches	inches	inches
806.128.61	10	7/16	1/2	2-9/32

### Spare parts

990.423.00	791.003.00	990.058.00	991.057.00

# FILE-FREE Flush Trim Bits for Laminate

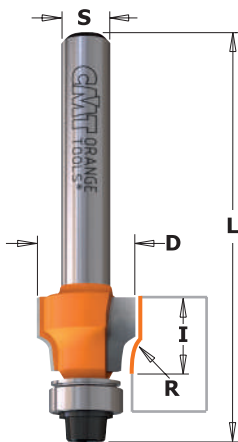

## 807



This bit is perfect for ensuring smooth flawless results on your laminate surfaces after flush trimming. Sharp edges are easily trimmed away, leaving your surfaces nice and smooth to the touch. No further filing is needed!

**SHOP TIPS:** after resharpening, replace bearing 791.002.00 (Ø9.5mm) with undersized bearing 791.062.00 (Ø9.3mm)

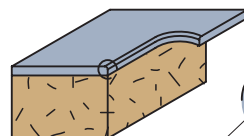

Drawing is 1:1 scale

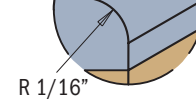
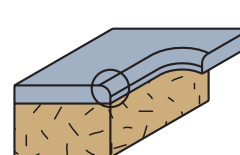
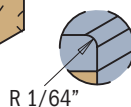

ORDER NO.		D		I	R	L
S=Ø1/4" shank		inches	mm	inches	inches	inches
807.004.11	10	1/2	12.7	3/8	1/64	2-3/64
807.015.11	10	1/2	12.7	3/8	1/16	2-3/64

### Spare parts

990.422.00	791.002.00	990.058.00	991.057.00
990.422.00	791.002.00	990.058.00	991.057.00

# Flush Trim Bits



## 806

Tough, versatile, fast-cutting CMT Flush Trim bits are ideal for a wide variety of trimming jobs. We offer a wide range of sizes that are sure to satisfy any woodworking need. Use these carbide tipped bits for precision work on laminates or for quick template work with excellent finish results.

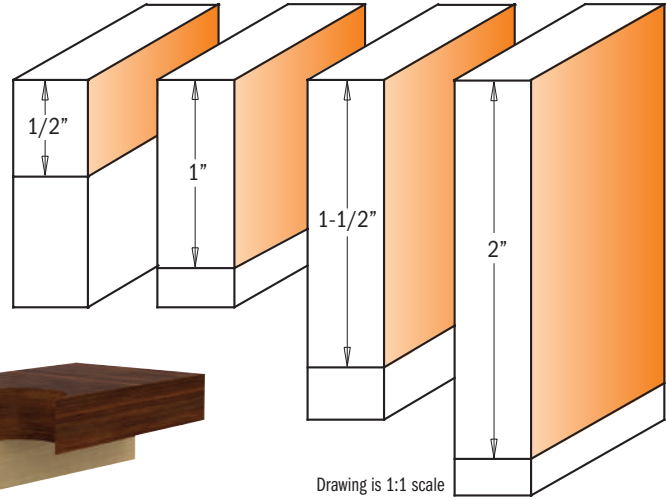

Drawing is 1:1 scale



**X10** (10 PCS. IN MASTERPACK)

### • Solid Carbide

ORDER NO. S=Ø1/4" shank	ORDER NO. S=Ø1/2" shank		I		D	L	α
			inches	mm	inches	inches	
● 806.064.11		10	1	25.4	1/4	2-1/2	0°
806.096.11		10	1/2	12.7	3/8	2-3/16	0°
806.128.11		10	1/2	12.7	1/2	2-9/32	-5° Neg.
	806.628.11	10	1/2	12.7	1/2	2-25/32	-5° Neg.
806.095.11		10	1	25.4	3/8	2-11/16	0°
806.127.11		10	1	25.4	1/2	2-25/32	-3° Neg.
	806.627.11	10	1	25.4	1/2	3-13/32	0°
	806.629.11	10	1-1/2	38.1	1/2	3-45/64	0°
	806.630.11	10	2	50.8	1/2	4-3/32	0°
806.191.11		10	1	25.4	3/4	2-29/32	-5° Neg.
	806.691.11	10	1	25.4	3/4	3-13/32	-5° Neg.
	806.692.11	10	1-1/2	38.1	3/4	3-21/32	-3° Neg.
	806.690.11	10	2	50.8	3/4	4-5/16	-3° Neg.
10 PCS. IN MASTERPACK							
806.096.11-X10			1/2	12.7	3/8	2-3/16	0°
806.095.11-X10			1	25.4	3/8	2-11/16	0°
806.127.11-X10			1	25.4	1/2	2-51/64	-3° Neg.
	806.627.11-X10		1	25.4	1/2	3-13/32	0°

### Spare parts

	791.035.00	541.009.00	990.113.00
990.422.00	791.002.00		990.058.00
990.423.00	791.003.00		990.058.00
990.423.00	791.003.00		990.058.00
990.422.00	791.002.00		990.058.00
990.423.00	791.003.00		990.058.00
990.423.00	791.003.00		990.058.00
990.423.00	791.003.00		990.058.00
990.425.00	791.004.00	541.550.00	990.058.00
990.425.00	791.004.00	541.550.00	990.058.00
990.425.00	791.004.00	541.550.00	990.058.00
990.425.00	791.004.00	541.550.00	990.058.00

Spare parts: 991.055.00 0.9mm hex key for screw (990.060.00)  
991.057.00 3/32" hex key for screw (990.058.00)

**SHOP TIPS:** after resharpening, replace bearing as follows:  
791.002.00 (Ø9.5mm) with undersized bearing 791.062.00 (Ø9.3mm)  
791.003.00 (Ø12.7mm) with undersized bearing 791.063.00 (Ø12.5mm)

### 3-FLUTE SUPER-DUTY FLUSH TRIM BIT

ORDER NO. S=Ø1/4" shank		I		D	L	α
		inches	mm	inches	inches	
806.227.11	10	1	25.4	1/2	2-25/32	0°

### Spare parts

990.423.00	791.003.00	990.058.00	991.057.00



**SHOP TIPS:** after resharpening, replace bearing 791.003.11 (Ø12.7mm) with undersized bearing 791.063.00 (Ø12.5mm)



# Super-duty Flush Trim Bit - XTREME Series

new

**CMT ORANGE TOOLS**

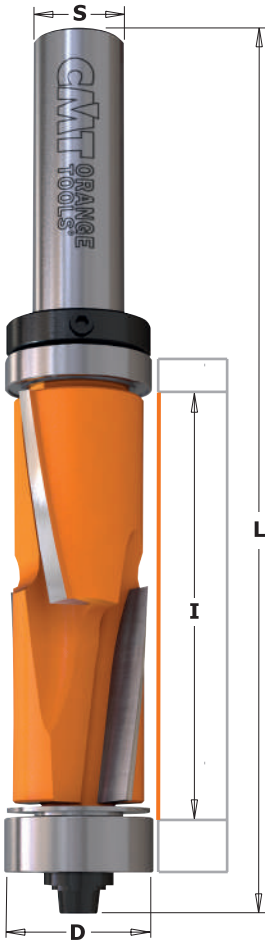

## 806B XTREME



These new XTreme flush trim bits guarantee the best possible finish along with extra-long life thanks to one-of-a-kind spiral technology. 4 cutting edges in high quality carbide are crafted using special brazing techniques as well as unique positive and negative design thus eliminating splintering on the upper and lower sides of the material you're working with.

Ideal for projects involving precious wood, melamine and delicate engineered veneers.

**NOTA:** use of variable speed routing machines is required.

19mm bits Max RPM 18.000  
35mm bits Max RPM 16.000

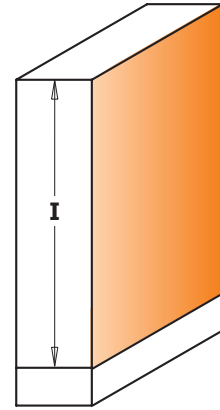
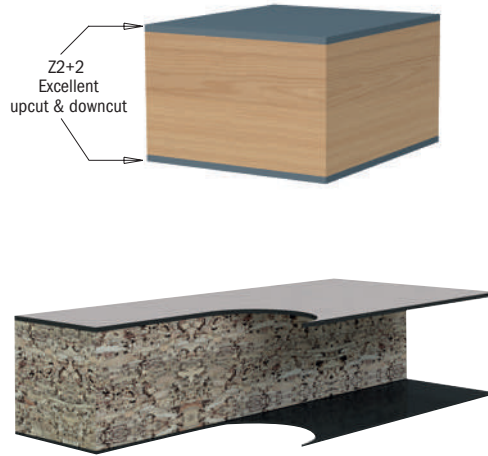

Drawing is 1:1 scale

ORDER NO. S=01/4" shank	ORDER NO. S=01/2" shank		I inches	I mm	D inches	L inches
806.127.41B		10	1	25.4	1/2	3-5/32
806.191.41B		10	1	25.4	3/4	3-3/8
	806.690.41B	10	2	50.8	3/4	4-29/64
	806.880.41B	10	2	50.8	1-3/8	4-27/32

Spare parts

990.423.00	791.003.00		791.010.00	541.001.00
990.425.00	791.004.00	541.550.00	791.004.00	541.001.00
990.425.00	791.004.00	541.550.00	791.011.00	541.002.00
990.426.00	791.029.00	541.552.00	791.029.00	541.002.00

Spare parts: 990.058.00 1/8"x3/8"x1/2" TCEI screw  
991.056.00 1.5mm hex key for screw (M3)  
991.057.00 3/32" hex key for screw (990.058.00)

## Flush Trim Bit Set



PACK QTY.  
5 PC

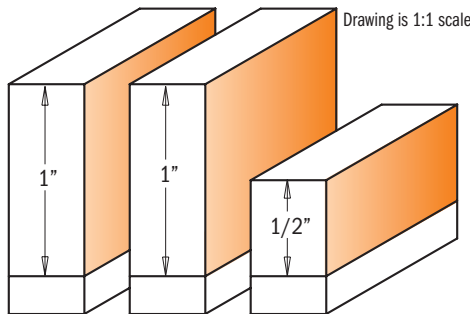

Drawing is 1:1 scale



Indispensable in any shop, the new 3 piece flush trim bit set gives you the option to trim laminates or do template work conveniently using just one instrument.

## 806.001.11

1/4" Shank

SET CONTAINS	ORDER NO. S=01/4" shank	D inches	D mm	I inches	L inches
Flush Trim bit	806.095.11	3/8	9.52	1	2-11/16
Flush Trim bit	806.096.11	3/8	9.52	1/2	2-3/16
Flush Trim bit	806.191.11	3/4	19.05	1	2-59/64

# Double-Bearing Spiral Flush Trim Bits

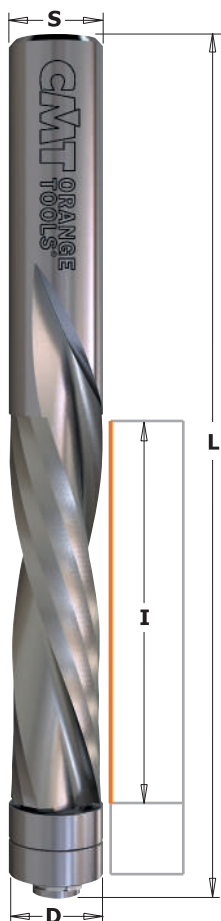

## 190B - 191B - 192B

CMT solid carbide spiral flush trim bits are composed of a special super-micrograin formulation increasing hardness with a higher transverse rupture point. Combined with a spiral cutting angle, CMT solid carbide spiral flush trim bits equipped with a double bearing, allow cabinet makers to shear wood and wood products cleanly, providing more efficient chip ejection than standard flush trim bits. In production settings, this means these bits will run cooler, stay sharper, last longer and increase shop productivity.

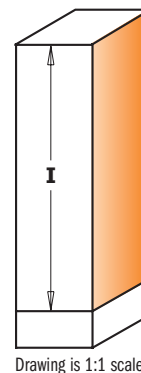
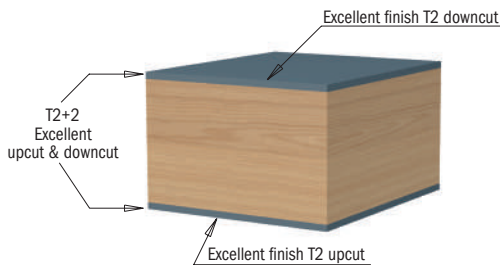
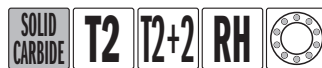

ORDER NO. S=01/4" shank	ORDER NO. S=01/2" shank		I inches	I mm	D inches	L inches	Spare parts		
2+2-EDGE UPCUT & DOWNCUT									
	<b>190.508.11B</b>	10	1-7/8	47.6	1/2	4-1/2	791.010.00		541.301.00
2-EDGE UPCUT									
	<b>191.008.11B</b>	10	1	25.4	1/4	3	791.035.00	541.009.00	
	<b>191.505.11B</b>	10	1-1/4	31.7	1/2	3-1/2	791.010.00		541.301.00
	<b>191.507.11B</b>	10	2	50.8	1/2	4-1/2	791.010.00		541.301.00
2-EDGE DOWNCUT									
	<b>192.008.11B</b>	10	1	25.4	1/4	3	791.035.00	541.009.00	
	<b>192.505.11B</b>	10	1-1/4	31.7	1/2	3-1/2	791.010.00		541.301.00
	<b>192.507.11B</b>	10	2	50.8	1/2	4-1/2	791.010.00		541.301.00

# 3-in-1 Flush Trim Bits for MDF/Laminate

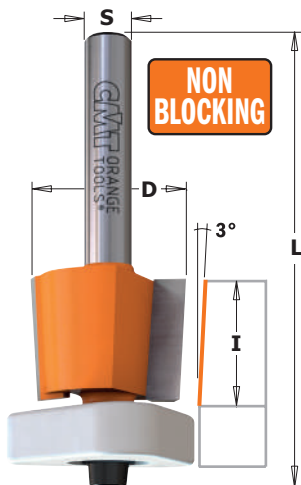

## 807

3 in 1 new flush trim bits with DELRIN® Triangular bearings are your best partner for laminate trimming. In fact, it solves three of the most common problems that occur when flush trimming:

- 1) The anti-stick properties of the DELRIN® bearing greatly reduces the likelihood of freezing of the bearing from glue.
- 2) The extended guide surface of the new DELRIN® bearing will perfectly match the work surface without scratching like a steel bearing would. The DELRIN® bearing also guarantees maximum stability.
- 3) The shear angle cutting edge reduces the need for filing. 3-in-1 bits are ideal on plastic laminates as well as aluminium laminates!

3-in-1 bits are ideal on plastic laminates as well as aluminium laminates!

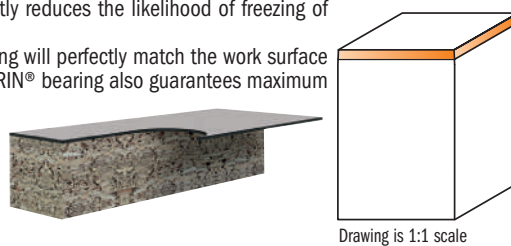

### Perfect trimming with conical edges!

Thanks to the innovative conical edges of this bit, you will always get perfect cuts even after re-sharpening. In fact, the most common problem you have with standard flush trim bits is the undersized diameter after re-sharpening which leaves a mark on the material; with the new CMT construction you could re-sharpen up to six times without any problem. Just remember to adjust your bit up or down as per the illustration.

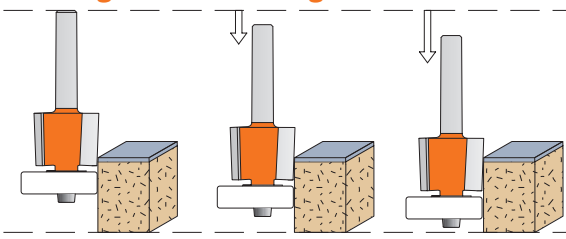

#### Patent No. D628,218

- Extended guide surface
- Non-freezing
- Non-scratch surface



ORDER NO. S=01/4" shank	ORDER NO. S=01/2" shank		I inches	I mm	D inches	L inches	Spare parts			
<b>807.128.11</b>		10	1/2	12.7	1/2	2-9/64				
<b>807.190.11</b>		10	5/8	15.87	3/4	2-11/32	990.422.00	791.042.00	990.058.00	991.057.00
	<b>807.690.11</b>	10	5/8	15.87	3/4	2-19/32	990.423.00	791.043.00	990.058.00	991.057.00
							990.423.00	791.043.00	990.058.00	991.057.00

# Flush Trim Bits with Insert Knives

INSERT CARBIDE T2 RH 2X CUTTING

## 657

Specially designed to perform difficult trimming operations, these bits are both indispensable and economical. Flush trim bits with two replaceable knives fixed by special TORX® screws. The 2-sided blades can create extra new edges. Guided flush trim bits type **657.1** are equipped with ball bearing guides.



**SAFETY TIPS:**



The **TW-006** Torque Screwdriver is recommended for the proper fastening of screws (see page 267).

**CORRECT KNIFE POSITIONING**

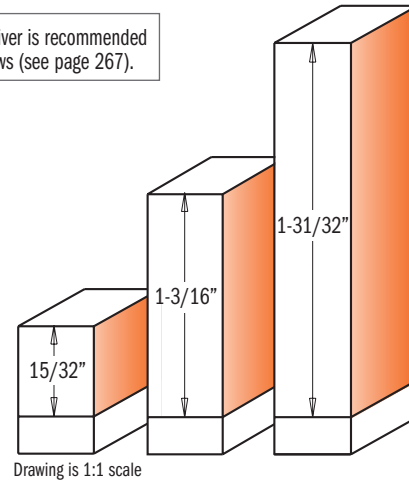
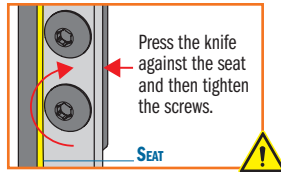

## 657.1



ORDER NO. S=Ø1/4" shank	ORDER NO. S=Ø1/2" shank		I inches	mm	D inches	L inches
<b>657.192.11</b>		10	15/32	12	3/4	2-1/4
	<b>657.692.11</b>	10	1-3/16	30	3/4	3-23/64
	<b>657.992.11</b>	10	1-31/32	50	3/4	4-13/32

**Spare parts**

790.120.00	990.075.00	991.061.00	791.007.00
790.300.00	990.075.00	991.061.00	791.007.00
790.500.00	990.075.00	991.061.00	791.007.00

Spare parts: **990.400.00** Ø3.2/Ø7mm shield for M3 screw  
**990.410.00** Ø4.2/Ø9mm shield for M4 screws  
**990.051.00** M3x6mm TCEI screws

**990.052.00** M4x6mm TCEI screws  
**991.067.00** 3mm hex key  
**541.514.00** Ø6.4mm shield

# Pattern/Flush Trim Bits with Insert Knives



## 657B

These bits complete the wide range of CMT Flush Trim bits equipped with a bearing. A larger 3/4" (19mm) diameter and double bearing distinguishes this bit from the others given its increased stability throughout flush and trimming operations. This means completing difficult projects safely, especially when you require a significant amount of swarf removal and an optimal precision finish.



### CORRECT KNIFE POSITIONING

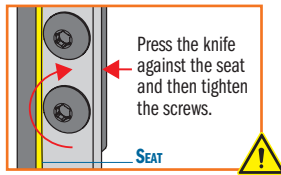

### SAFETY TIPS:



The **TW-006** Torque Screwdriver is recommended for the proper fastening of screws (see page 267).

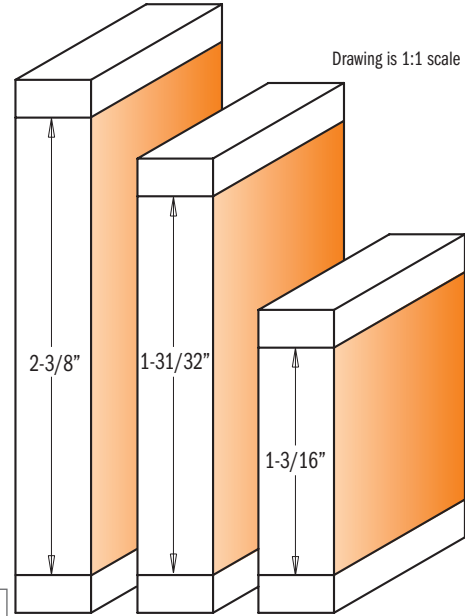

ORDER NO.		I	D	L
S=01/2" shank		inches	mm	inches
<b>657.692.11B</b>	10	1-3/16	30	3/4
<b>657.994.11B</b>	10	1-31/32	50	3/4
<b>657.996.11B</b>	10	2-3/8	60	3/4

### Spare parts

790.300.00	990.075.00	791.007.00	990.052.00	791.011.00	541.002.00
790.500.00	990.075.00	791.007.00	990.052.00	791.011.00	541.002.00
790.600.00	990.075.00	791.007.00	990.052.00	791.011.00	541.002.00

Spare parts: **990.410.00** Shield Ø4.2/Ø9mm for M4 screws  
**991.067.00** 3mm hex key

**991.061.00** T15 TORX® key  
**991.056.00** 1.5mm hex key



## Flush Trim Router Bits with Double Bearing

## 806B

This innovative two-flute router bit is equipped with a double bearing and feature a down shear design allowing cleaner, smoother cuts on a variety of materials.

Now it's no longer necessary to flip or move your tool during routing operations. This tool is particularly effective when routing curved elements along or against the grain.

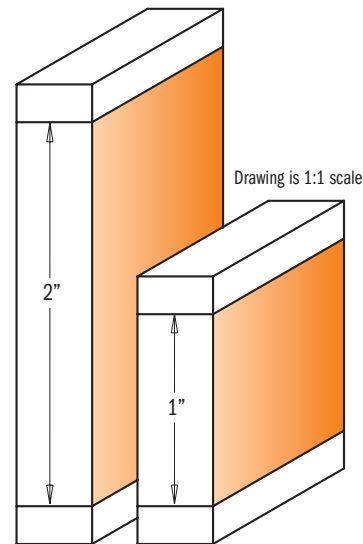

ORDER NO.		I	D	L	α
S=01/2" shank		inches	mm	inches	
<b>806.691.11B</b>	10	1	25.4	3/4	3-13/32 -5° Neg.
<b>806.690.11B</b>	10	2	50.8	3/4	4-5/16 -3° Neg.

### Spare parts

990.425.00	791.004.00	541.550.00	990.058.00	791.011.00	541.002.00
990.425.00	791.004.00	541.550.00	990.058.00	791.011.00	541.002.00

Spare parts: **991.057.00** 3/32" hex key



Panel Pilot Bits with Guide

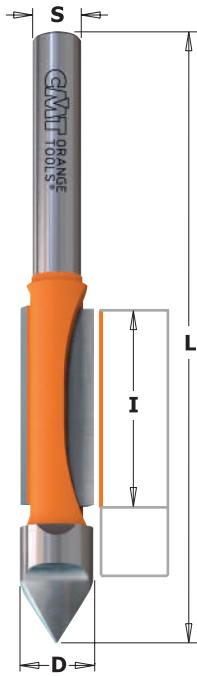

**816**

How much time do you end up spending making openings in paneling, drywall, siding, doors or windows? With the CMT panel pilot bit, the job just got quicker. The point of this bit as well, plunge smoothly and easily and the carbide edges cut clean and fast. All of this adds up to accurate cuts in less time and with less effort - great for trimming veneer as well as a variety of laminates.

**SAFETY TIPS:** always use extra caution when working near electrical outlets and boxes - always shut off the power. Make sure the bit does not go so deep as to touch or cut the wires.



**816.064**  
• Solid Carbide

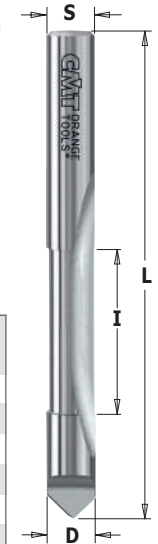

**X10** (10 PCS. IN MASTERPACK)

ORDER NO. S=01/4" shank	ORDER NO. S=01/2" shank		D inches	D mm	I inches	L inches	T
<b>816.064.11</b>		10	1/4	6.35	3/4	2-1/2	1
<b>816.095.11</b>		10	3/8	9.52	1	3-1/16	2
	<b>816.627.11</b>	10	1/2	12.7	1-1/4	4	2
<b>10 PCS. IN MASTERPACK</b>							
<b>816.064.11-X10</b>			1/4	6.35	3/4	2-1/2	1
	<b>816.627.11-X10</b>		1/2	12.7	1-1/4	4	2

Panel Pilot Bits with Guide

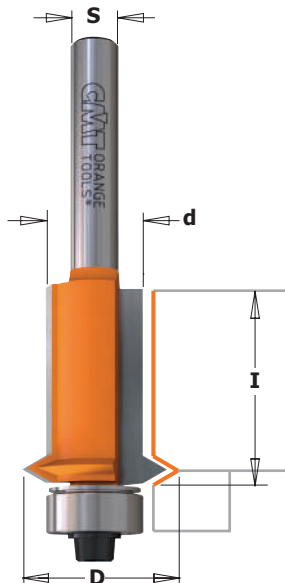

**853**

An absolutely indispensable bit for making cabinets. CMT Flush and V-Groove bits allow you to make cabinet front frames in 25mm stock that fit perfectly with the sides. The added V-cutter feature makes a decorative groove along the hinge joint to hide the seam.

**SHOP TIPS:** For best results, leave less than 3mm overhang on cabinet front frames for easier routing.

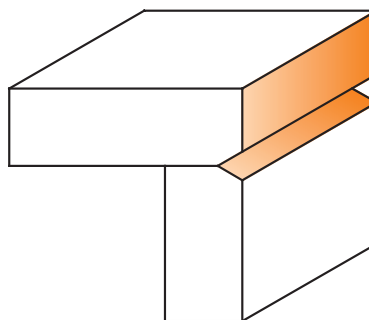

Drawing is 1:1 scale

ORDER NO. S=01/4" shank	ORDER NO. S=01/2" shank		d inches	d mm	D inches	I inches	L inches
<b>853.001.11</b>		10	1/2	12.7	3/4	1	2-41/64
	<b>853.501.11</b>	10	1/2	12.7	3/4	1	3-1/64

Spare parts

990.423.00	791.003.00	990.058.00	991.057.00
990.423.00	791.003.00	990.058.00	991.057.00

# Rabbeting Sets

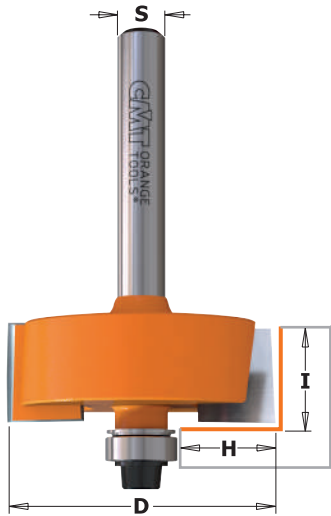

## 835



CMT rabbeting sets include one rabbeting bit, 6 interchangeable ball bearing guides, fastening screws, shields, and an Allen Key. In order to change cutting depth, substitute the bearing.

**791.703.00** Standard



**BE SURE** to keep the black bearing washer right side up to correspond with the bearing rotation when re-assembling the bearing. Improper re-assembly can cause the screw to come loose.

ORDER NO. S=01/4" shank	ORDER NO. S=01/2" shank		H inches	H mm	D inches	I inches
835.001.11	835.501.11	5	0 to 1/2	0 - 12.7	1-3/8	1/2
	835.502.11	5	0 to 1/2	0 - 12.7	1-3/8	3/4

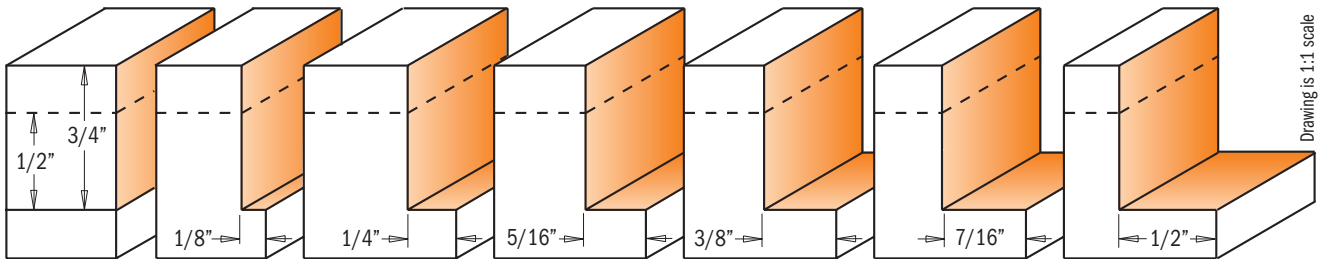

# Rabbeting Bits with Insert Knives

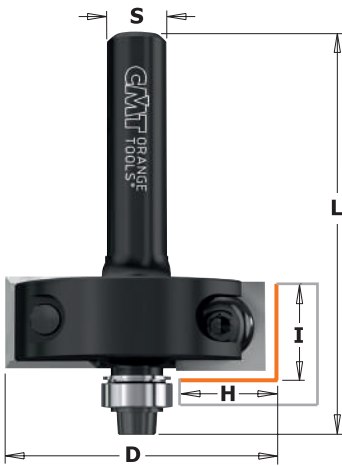

Standard

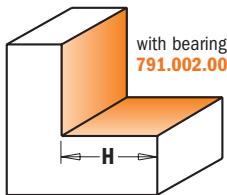

Drawing is 1:1 scale

CORRECT KNIFE POSITIONING

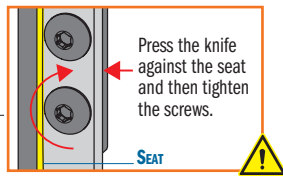

## 660



Rabbeting bits for creating cabinet doors, backsides and drawer fronts. Every bit is equipped with a standard bearing (791.002.00), but other bearings are also available in order to craft a variety of rabbeting widths. For use on chipboard, wood or MDF.

SAFETY TIPS:



The **TW-006** Torque Screwdriver is recommended for the proper fastening of screws (see page 267).

**791.703.00** Optional



With this kit **791.703.00** you can carry out all cutting depths below.

Drawing is 1:1 scale

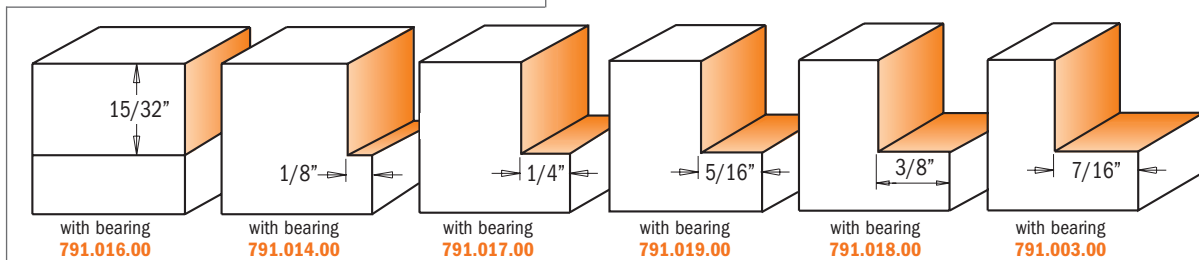

ORDER NO. S=01/4" shank	ORDER NO. S=01/2" shank		H inches	H mm	D inches	I inches	L inches
660.351.11		10	1/2	12.7	1-3/8	15/32	2-1/8
	660.851.11	10	1/2	12.7	1-3/8	15/32	2-33/64

Spare parts

790.120.00	990.422.00	791.002.00	991.061.00
790.120.00	990.422.00	791.002.00	991.061.00

Spare parts: 990.075.00 M4x6mm TORX® screw

990.058.00 1/8"x3/8"x1/2" TCEI screw

# The CMT Grand Rabbet Set



"The Grand Rabbet" by CMT is an investment that shows your commitment to quality. This CMT product will deliver years of reliable service under normal use. For safe and trouble-free results please observe the following instructions and safety precautions. The complete kit (item code **835.503.11**), will enable you to produce 17 different rabbet sizes including rabbets for under-sized plywood applications. For rabbet sizes over 1/2" (12.7mm), make the cuts in several shallow passes until the desired depth is achieved. Available in 1/2" (12.7mm) shanks.

PACK QTY. 1 PC



## 835.503.11

1/2" Shank

SET CONTAINS	ORDER NO. S=01/2" shank	H		D
		inches	mm	
Rabbeting bit	<b>835.990.11</b>	5/8	15.87	2

**835.990**

- 791.705.00 5 pcs. collar set (1/16" - 1/8" - 1/4" - 3/8" - 1/2" rabbets)
- 791.706.00 5 pcs. collar set (3/16" - 5/16" - 7/16" - 9/16" - 11/16" rabbets)
- 791.707.00 5 pcs. collar set (15/64" - 23/64" - 15/32" - 19/32" - 23/32" rabbets)
- 799.517.00 2" collar for Flush Trim

2" Collar Flush Trim order no. **799.517.00**

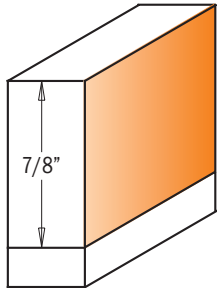

Order no. **791.705.00**

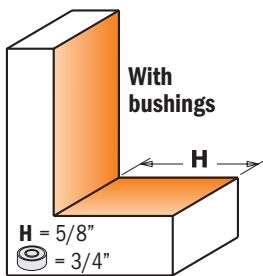
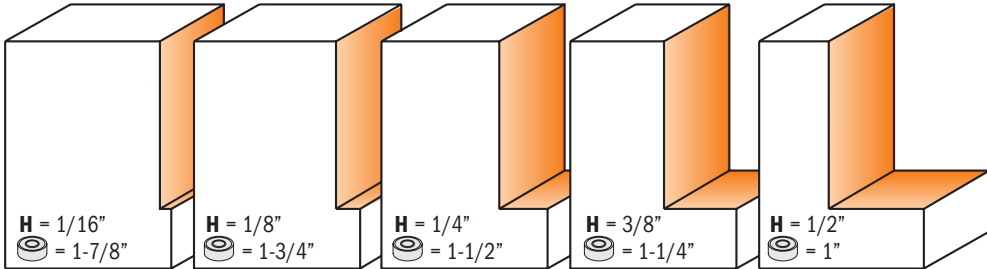

Order no. **791.706.00**

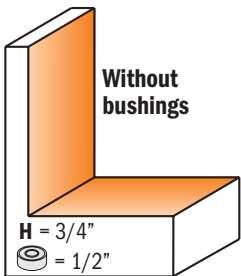
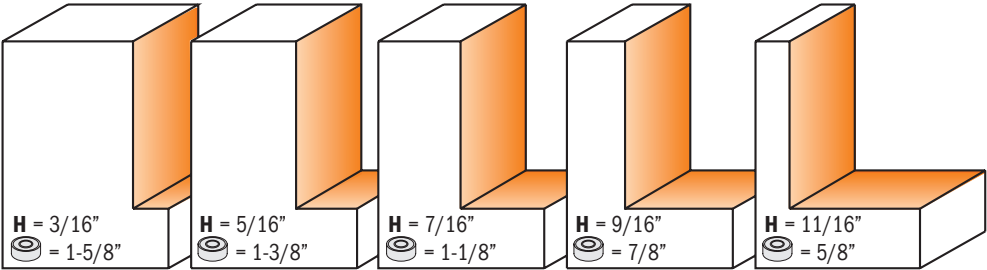

Order no. **791.707.00**

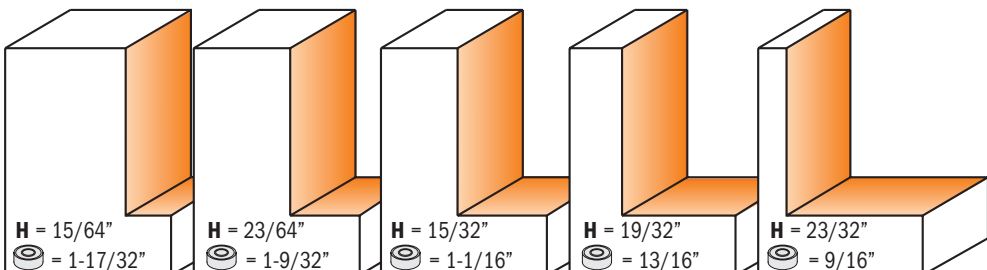

Drawing is 1:1 scale

# Rabbeting Bits

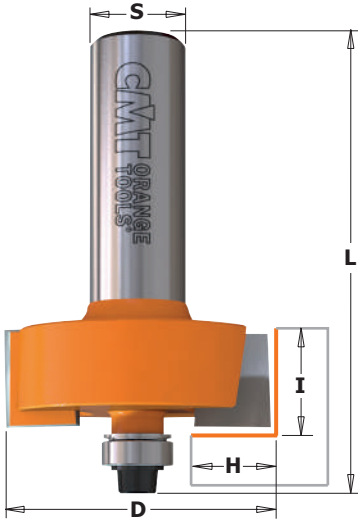

## 835



CMT carbide-faced rabbeting bits are fast and accurate - you can quickly produce inset doors and drawer fronts, make strong rabbet joints, mill perfect tongue and groove joints or any number of other jobs usually time consuming and difficult. Other possibilities for these tungsten carbide bits are illustrated below and on the following pages.

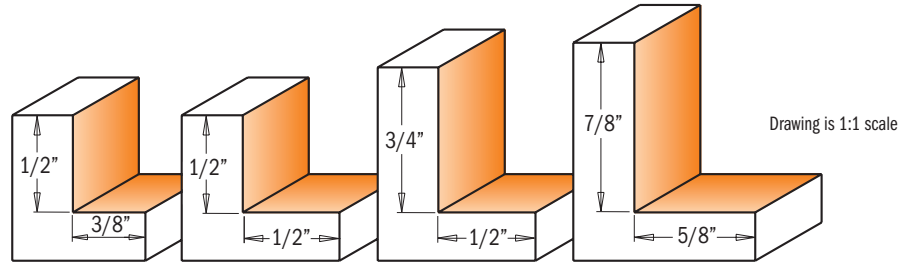

ORDER NO. S=Ø1/4" shank	ORDER NO. S=Ø1/2" shank		H inches	mm	D inches	I inches	L inches
835.317.11		10	3/8	9.52	1-1/4	1/2	2-5/16
	835.817.11	10	3/8	9.52	1-1/4	1/2	2-13/32
835.350.11	835.850.11	10	1/2	12.7	1-3/8	1/2	2-11/32
	835.851.11	10	1/2	12.7	1-3/8	3/4	2-19/32
	835.990.11	10	5/8	15.87	2	7/8	3-1/16

### Spare parts

990.423.00	791.003.00	990.058.00	991.057.00
990.423.00	791.003.00	990.058.00	991.057.00
990.422.00	791.002.00	990.058.00	991.057.00
990.422.00	791.002.00	990.058.00	991.057.00
990.408.00	791.010.00	990.058.00	991.057.00

Spare parts: 541.514.00 2mm spacer (for 835.990.11)  
799.503.00 3/4" bushings (for 835.990.11)

# Grand Rabbeting Bits with Insert Knives



## 660.9



"The Grand Rabbet" by CMT is an investment that shows your commitment to quality. This CMT product will enable you to produce 17 different rabbet sizes including rabbets for under-sized plywood applications. For rabbet sizes over 1/2", make the cuts in several shallow passes until the desired depth is achieved. Available in 1/2" shanks.

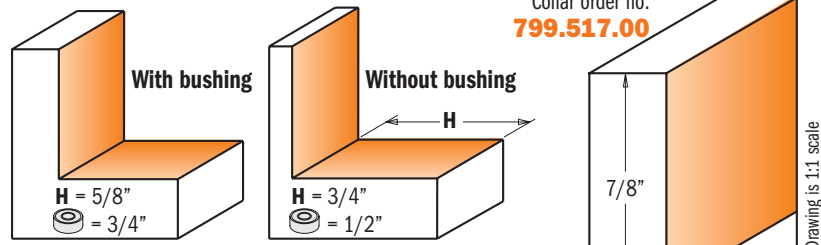

### CORRECT KNIFE POSITIONING

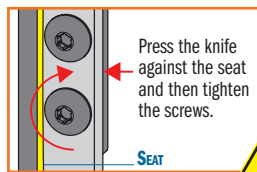

### SAFETY TIPS:

The **TW-006** Torque Screwdriver is recommended for the proper fastening of screws (see page 267).

ORDER NO. S=Ø1/2" shank		H inches	mm	D inches	I inches	L inches
660.991.11	10	5/8	15.87	2	1-1/8	3-3/8

### Spare parts

790.283.12	990.075.00	991.061.00	791.010.00

Spare parts: 541.514.00 Ø6.4mm stop collar  
799.503.00 Ø19.05mm bushings  
990.410.00 Ø4.2/Ø9mm shield for M4 screw  
990.052.00 M4x6mm TCEI screw  
991.067.00 3mm hex key  
990.469.00 Kit screw, shield and key  
Optional: 799.517.00 Bushing for flush trim Ø50.8mm  
791.705.00 5 pcs. bushing set (H=1.6-3.2-6.35-9.5-12.7mm rabbets)  
791.706.00 5 pcs. bushing set (H=4.7-8-11.1-14.3-17.5mm rabbets)  
791.707.00 5 pcs. bushing set (H=6-9.1-11.9-15-18.2mm rabbets)



# Keyhole Bits

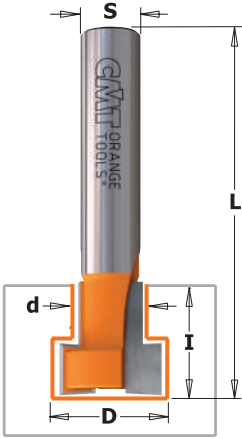

## 850.0\_5

This keyhole bit allows you to craft perfect holes that will keep your frames, plaques or any wall hanging perfectly straight, as if floating on the wall. The bit bores an entry hole in the wood, then proceeds to cut a 3/16" hole and finishes by boring a larger opening under the surface.

**SAFETY TIPS:** Be sure the workpiece is securely fastened to the router table or work bench.  
**SHOP TIPS:** Recommended for use with a plunge router.

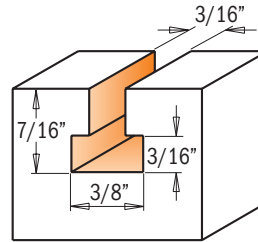
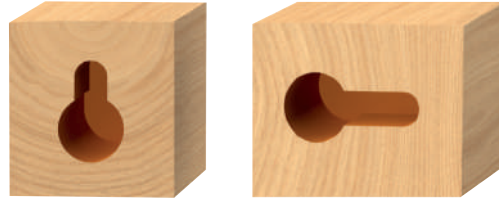

Drawing is 1:1 scale

SOLID CARBIDE CARBIDE TIPPED T1 T2 RH



**850.501.21**  
3/8" shank

ORDER NO. S=01/4" shank	ORDER NO. S=01/2" shank		D	D	d	I	L	S
			inches	mm	inches	inches	inches	inches
850.001.11	850.501.11	10	3/8	9.52	3/16	7/16	2-1/8	
<b>new</b>	• 850.501.21	10	3/8	9.52	3/16	7/16	2-9/16	3/8

• Solid Carbide

# T-Slot Bits

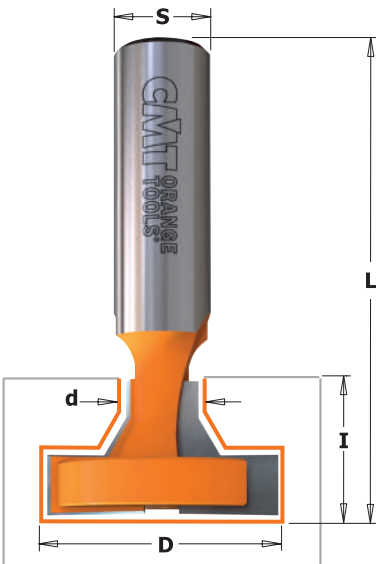

## 850.6

The perfect bit for crafting wall panel slots. This bit is not designed for plunging operations. For best results, use in CNC machinery and table-mounted routers.

CARBIDE TIPPED T2 RH

ORDER NO. S=01/2" shank		D	D	d	I	L
		inches	mm	inches	inches	inches
850.603.11	10	1-7/64	28	7/16	17/32	2-7/32
850.601.11	10	1-3/16	30	3/8	11/16	2-3/8
850.602.11	10	1-3/8	34.9	1/2	7/8	2-1/2

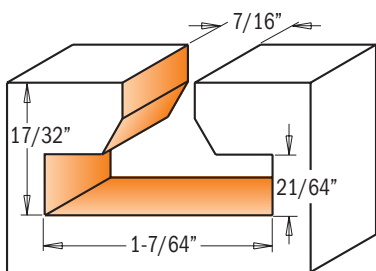

**850.603.11**

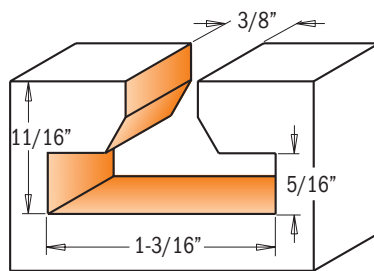

**850.601.11**

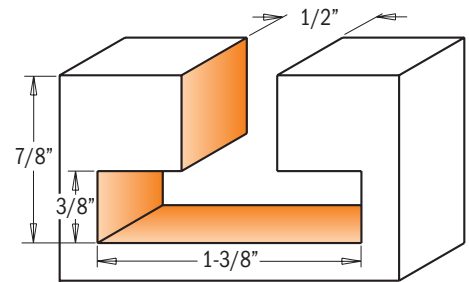

**850.602.11**

Drawing is 1:1 scale

# Screw Slot Bits

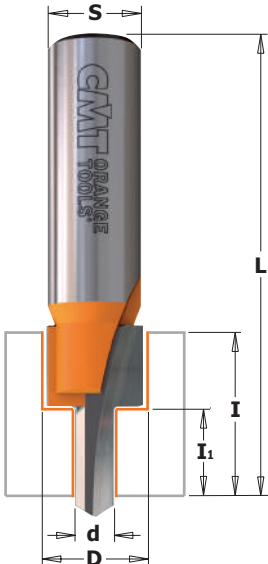

## 813

Any large panel or table top should be secured in a way that allows it to expand or contract without splitting. These screw-slot bits let you create screw slots so that panels can be held in place but are able to slide back and forth without splitting the wood or breaking the screw securing them.

Both have 1/2" shank and the codes **813.701.11** are for countersink screws, while the codes **813.601.11** are for counterbored screws.

CARBIDE TIPPED T2 RH

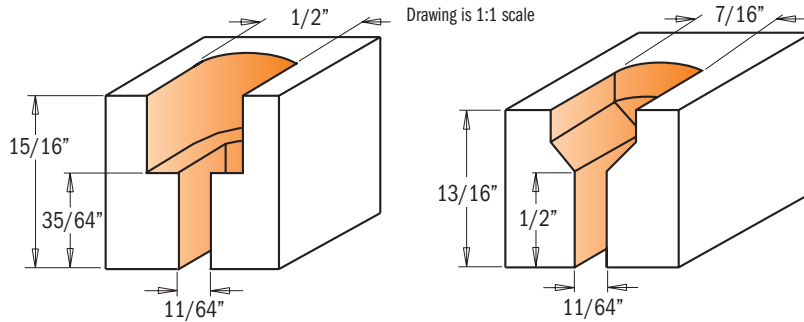

**813.701.11**

**813.601.11**

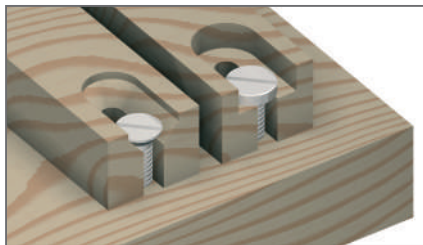

ORDER NO.		D		d	I <sub>1</sub>	I	L
S=01/2" shank		inches	mm	inches	inches	inches	inches
<b>813.701.11</b>	10	7/16	11.1	11/64	1/2	13/16	2-1/2
<b>813.601.11</b>	10	1/2	12.7	11/64	35/64	15/16	2-1/2

# Flooring Router Bits

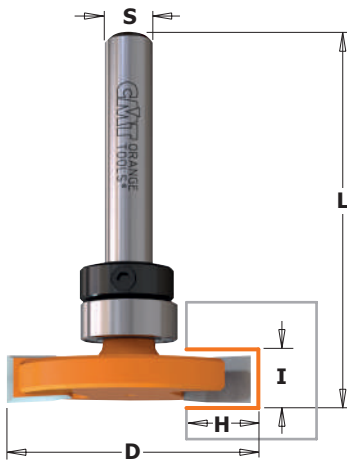

## 822.023B - 822.024B

CARBIDE TIPPED T2 RH

CMT now offers you these industrial quality carbide-tipped router bits for flooring and inlay applications. They easily and smoothly run through solid and timber wood while cutting edges and remain sharp even after several passes **822.024.11B** item number also features rounded edges to produce 1/8" radius inlays.

These bits are equipped with a stop collar and a bearing.

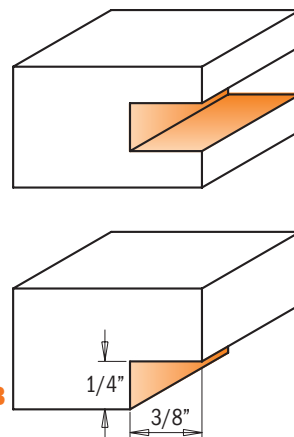

Drawing is 1:1 scale

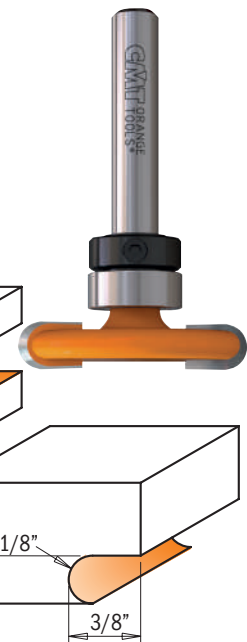

**822.024.11B**

**822.023.11B**

ORDER NO.		D		I	H	R	L
S=01/4" shank		inches	mm	inches	inches	inches	inches
<b>822.023.11B</b>	10	1-1/4	31.75	1/4	3/8		1-7/8
<b>822.024.11B</b>	10	1-1/4	31.75	1/4	3/8	1/8	1-7/8

Spare parts

791.010.00	541.001.00	990.005.00	991.056.00
791.010.00	541.001.00	990.005.00	991.056.00

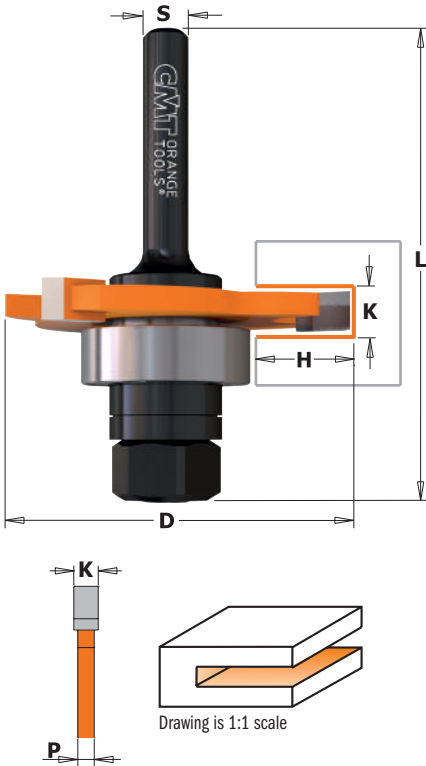

**822A/B**

These Slot Cutters are great for splines, biscuits, T-molding & more. For biscuit joining use the 5/32" cutter. Available as a cutter only, or with your choice of 1/4" or 1/2" diameter arbor with a 7/8" diameter bearing for cutting depth up to 1/2".

**NOTE:** for 9.5mm or 6.35mm depths, you can order the bearing kit **791.711.00** (with 28.5mm - 34.9mm diameters).

ORDER NO. S=Ø1/4" shank	ORDER NO. S=Ø1/2" shank		K		D	H	P	L
			inches	mm	inches	inches	inches	inches
<b>822.316.11A</b>	<b>822.316.11B</b>	10	1/16	1.6	1-7/8	1/2	0.043	2-13/32
<b>822.320.11A</b>	<b>822.320.11B</b>	10	5/64	2	1-7/8	1/2	0.051	2-13/32
<b>822.324.11A</b>	<b>822.324.11B</b>	10	3/32	2.4	1-7/8	1/2	0.051	2-13/32
<b>822.332.11A</b>	<b>822.332.11B</b>	10	1/8	3.2	1-7/8	1/2	0.051	2-13/32
<b>822.340.11A</b>	<b>822.340.11B</b>	10	5/32	4	1-7/8	1/2	0.082	2-13/32
<b>822.348.11A</b>	<b>822.348.11B</b>	10	3/16	4.8	1-7/8	1/2	0.114	2-13/32
<b>822.360.11A</b>	<b>822.360.11B</b>	10	15/64	6	1-7/8	1/2	0.177	2-13/32
<b>822.364.11A</b>	<b>822.364.11B</b>	10	1/4	6.35	1-7/8	1/2	0.177	2-13/32

**822**

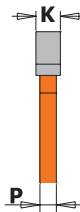
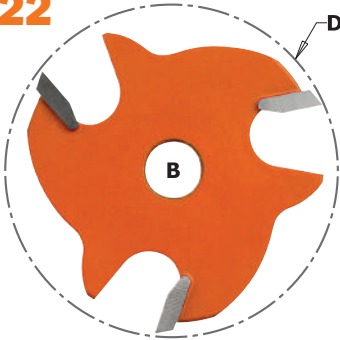

ORDER NO.		K		D	B	P
		inches	mm	inches	mm	inches
<b>822.316.11</b>	10	1/16	1.6	1-7/8	8	0.043
<b>822.320.11</b>	10	5/64	2	1-7/8	8	0.051
<b>822.324.11</b>	10	3/32	2.4	1-7/8	8	0.051
<b>822.332.11</b>	10	1/8	3.2	1-7/8	8	0.051
<b>822.340.11</b>	10	5/32	4	1-7/8	8	0.082
<b>822.348.11</b>	10	3/16	4.8	1-7/8	8	0.114
<b>822.360.11</b>	10	15/64	6	1-7/8	8	0.177
<b>822.364.11</b>	10	1/4	6.35	1-7/8	8	0.177

**1 824.xxx.00**

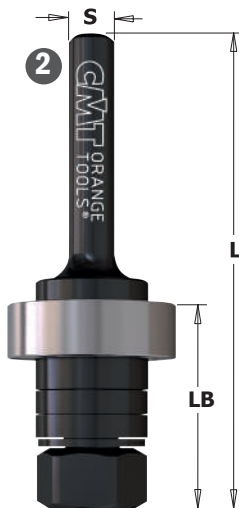

**824.xxx.10**

ORDER NO. S=Ø1/4" shank	ORDER NO. S=Ø1/2" shank		DESCRIPTION	LB inches	L inches
<b>824.064.00</b>		10	Slot cutter arbor without bearing	1-1/32	2-13/32
	<b>824.127.00</b>	10	Slot cutter arbor without bearing	1-1/32	2-21/32
<b>824.064.10</b>		10	Slot cutter arbor with bearing	1-1/32	2-13/32
	<b>824.127.10</b>	10	Slot cutter arbor with bearing	1-1/32	2-21/32

Spare parts: **791.005.00** Ø8-22mm bearing  
**541.501.00** 4mm spacer  
**541.500.00** 3mm spacer

**541.518.00** 1mm spacer  
**990.020.00** M8 nut

# Slot Cutters

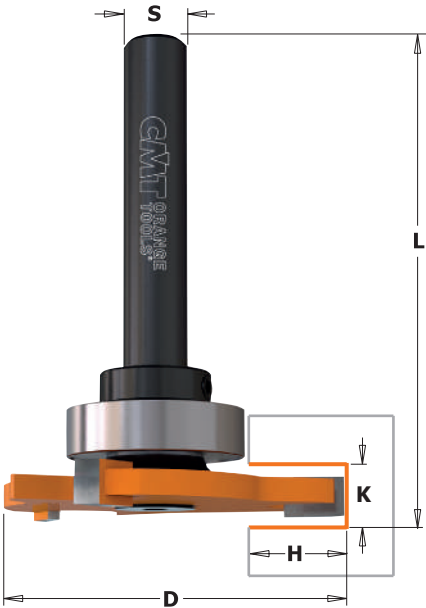

## 823B

The uses of this bit are infinite: not only can you rout grooves and rabbets, but you can even create T or dovetail joints and create biscuit and spline recesses on wood panels. Each bit features three carbide-tipped cutters, orange coloured P.T.F.E. coating and anti-kickback design.

**NOTE:** This cutter comes with a Ø22mm bearing for 2.8mm depth cuts. By ordering different bearings this depth can be shortened.

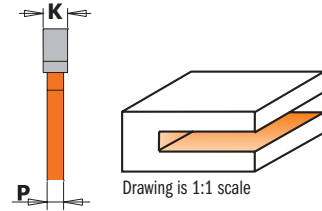

ORDER NO. S=Ø1/2" shank		K		P	D	H	L
		inches	mm	inches	inches	inches	inches
<b>823.332.11B</b>	10	1/8	3.2	0.050	1-7/8	1/2	2-17/64
<b>823.340.11B</b>	10	5/32	4	0.081	1-7/8	1/2	2-19/64
<b>823.364.11B</b>	10	1/4	6.35	0.175	1-7/8	1/2	2-25/64

## 823

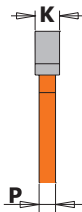
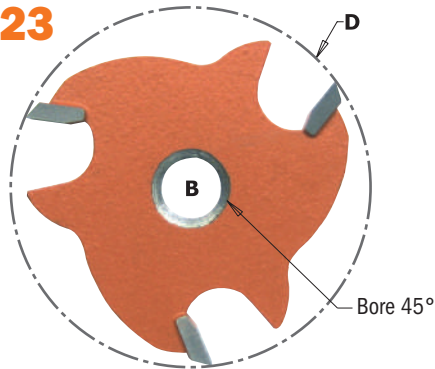

These 3-wing carbide tipped slot cutters feature anti-kickback design and CMT's trademark orange P.T.F.E. Industrial Coating for carrying out lateral grooves. For use with cutter arbors **824** (Ø1/4" & Ø1/2").

ORDER NO.		K		P	D	B
		inches	mm	inches	inches	mm
<b>823.332.11</b>	10	1/8	3.2	0.050	1-7/8	8
<b>823.340.11</b>	10	5/32	4	0.081	1-7/8	8
<b>823.364.11</b>	10	1/4	6.35	0.175	1-7/8	8

## 824



with stop collar  
**824.061.00**  
**824.061.10**  
**824.121.00**  
**824.121.10**



**824.122.00**  
**824.122.10**

### Assembly Illustration

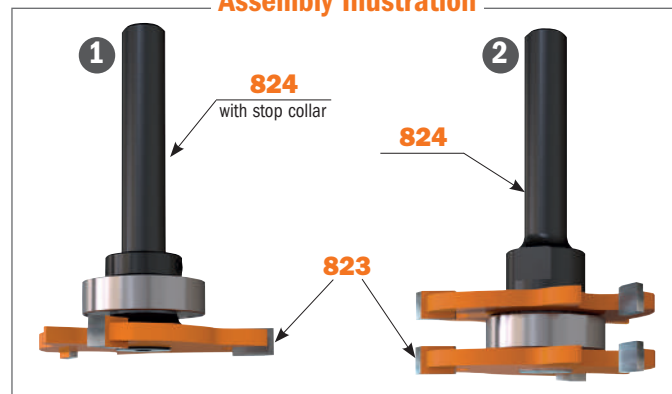

ORDER NO. S=Ø1/4" shank	ORDER NO. S=Ø1/2" shank		DESCRIPTION
<b>824.061.00</b>	<b>824.121.00</b>	10	Slot cutter arbor without bearing/stop collar
<b>824.061.10</b>	<b>824.121.10</b>	10	Slot cutter arbor with bearing/stop collar
	<b>824.122.00</b>	10	Slot cutter arbor without bearing
	<b>824.122.10</b>	10	Slot cutter arbor with bearing

**Spare parts:** 791.012.00 Ø8-22mm bearing  
 541.001.00 Stop collar for Ø1/4" shanks  
 541.002.00 Stop collar for Ø1/2" shanks  
 791.013.00 Ø1/2"-7/8" bearing  
 541.515.00 0.1mm spacer

541.516.00 0.3mm spacer  
 541.517.00 0.5mm spacer  
 541.518.00 1mm spacer  
 990.055.00 M5x12mm TSPEI screw  
 991.067.00 3mm hex key



# 3-Wing Slot Cutter

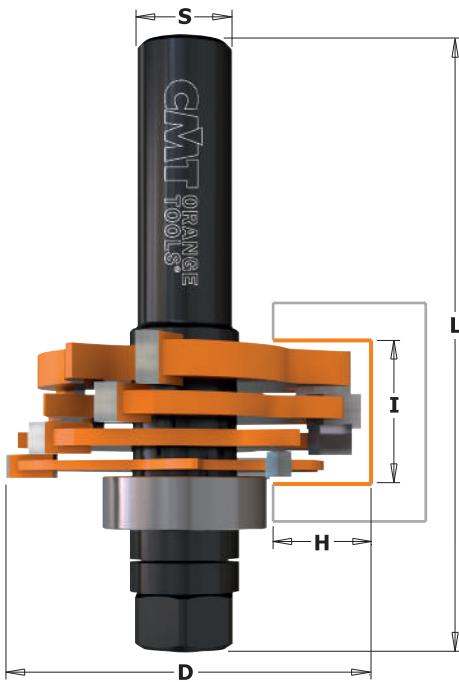

## 800.506

The Three Wing Slot Cutter Set routs slots, grooves and rabbets from 1/8" to 23/32" deep. Ideal for biscuit joints and milling perfect tongue and groove joints.

The set includes:

- 4 carbide tipped cutters 1/8", 5/32", 3/16", 1/4"
- 1 arbor 1/2"
- 1 ball bearing (22mm) for 1/2" cut.
- 17 shims: (8 x 0.1mm, 4 x 0.5mm, 3 x 1mm, 2 x 4mm).

### SAFETY PRECAUTIONS:

never use without shims between the cutters and between the cutter & bearing.

### SHOP TIPS:

the bearings kit **791.711.00** reaches 1/4" and 3/8" cutting depth.

**NOTE:** the carbide edges of the cutters must never touch; arrange the shims as illustrated here. Use only thicknesses provided in the set. Be sure all cutters are assembled in the correct rotational direction. Looking downwards on the arbor, the cutters will turn clockwise.

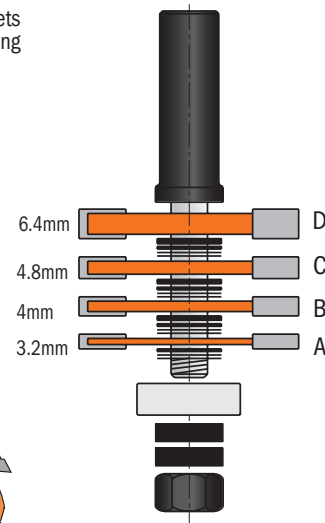
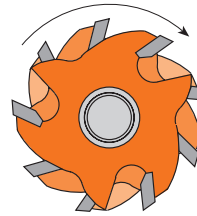

Cutter combinations	Cutter height	inches	inches
A	0.126		
B	0.157		
C	0.189		
D	0.252		
A + B	0.252	to	0.279
A + C	0.283	to	0.311
A + D	0.346	to	0.374
B + C	0.315	to	0.342
B + D	0.378	to	0.405
C + D	0.409	to	0.437
A + B + C	0.409	to	0.464
A + B + D	0.468	to	0.523
A + C + D	0.500	to	0.555
B + C + D	0.531	to	0.586
A + B + C + D	0.626	to	0.708

Use shims to adjust cut width: MIN. 0.039" - MAX 0.066"

ORDER NO.	S=01/2" shank	I	D	H	L
		inches	inches	inches	inches
<b>800.506.11</b>	<b>10</b>	1/8 to 23/32	1-7/8	1/2	3-3/16

Spare parts	824.128.00	791.005.00	990.020.00
0.1mm spacer			
0.5mm spacer			
1mm spacer			
4mm spacer			

Spare parts: **541.515.00** 0.1mm spacer      **Optional: 791.711.00** 2 pcs bearing set for depth variations 1-1/8" & 1-3/8"  
**541.517.00** 0.5mm spacer  
**541.518.00** 1mm spacer  
**541.501.00** 4mm spacer

# Tongue & Groove Set

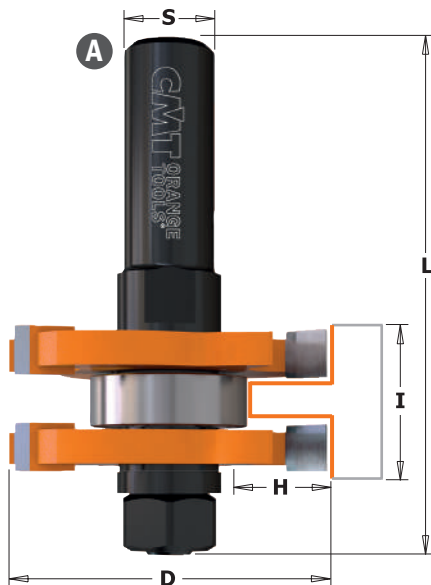

## 800.626

Make tongue and groove joints without the complicated process of taking apart and reassembling bits. The new CMT tongue and groove set gives you one bit to groove the slot and a separate bit to mill the tongue. Or use your imagination and put them to work individually on other projects. Makes tongue and groove cuts in wood up to 3/4" thickness.

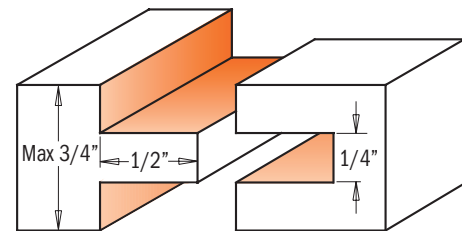

Drawing is 1:1 scale

ORDER NO.	S=01/2" shank	I	D	H	L	PROFILE
		inches	inches	inches	inches	
<b>800.626.11</b>	<b>5</b>	3/4	1-7/8	1/2	2-51/64	A+B
<b>800.626.11M</b>	<b>10</b>	3/4	1-7/8	1/2	2-51/64	A

Spare parts	824.131.00	791.005.00	822.364.11	990.020.00
0.1mm spacer				
0.3mm spacer				
0.5mm spacer				

Spare parts: **541.515.00** 0.1mm spacer      **541.518.00** 1mm spacer  
**541.516.00** 0.3mm spacer      **541.500.00** 3mm spacer  
**541.517.00** 0.5mm spacer

# Finger Joint Bit

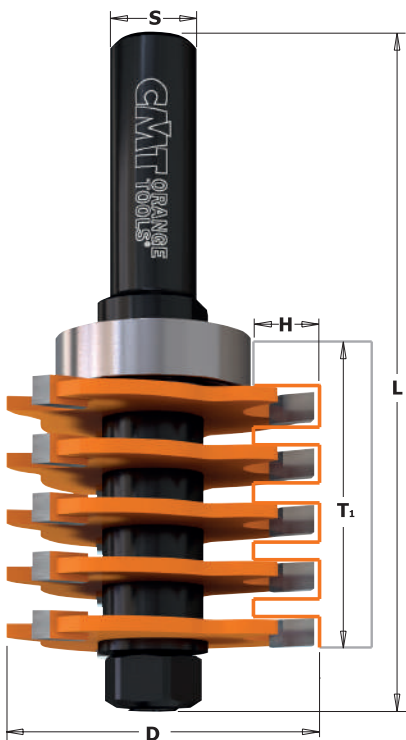

## 800.616



This router allows you to carry out accurate and functional finger joints with the greatest of ease. Without any adjustment you will be able to work woods with different thicknesses as indicated in the drawing. The bearing allows you to reach a 3/8" cutting depth. For further cutting depths you need to use a fence.

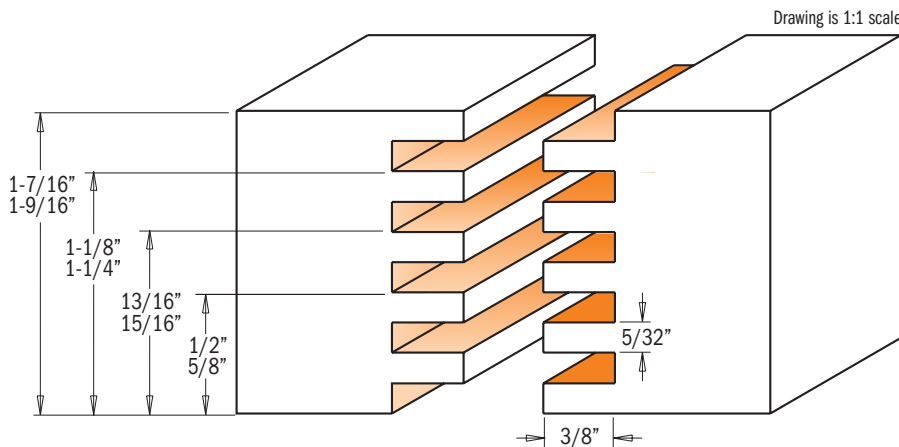

ORDER NO.		D		H	T <sub>1</sub>	L
S=Ø1/2" shank		inches	mm	inches	inches	inches
800.616.11	5	1-7/8	47.6	3/8	1/2 - 1-9/16	3-13/16

Spare parts			
824.130.00	791.027.00	822.340.11	990.020.00

Spare parts: 541.515.00 0.1mm spacer  
 541.519.00 5.8mm spacer  
 990.403.00 1.6mm washer  
 990.459.00 Kit with spacers

Optional: 791.020.00 Ø1-1/2" bearing (for depth 3/16")  
 791.029.00 Ø1-3/8" bearing (for depth 1/4")  
 791.015.00 Ø1-1/4" bearing (for depth 5/16")  
 791.011.00 Ø3/4" bearing (for depth 9/16")

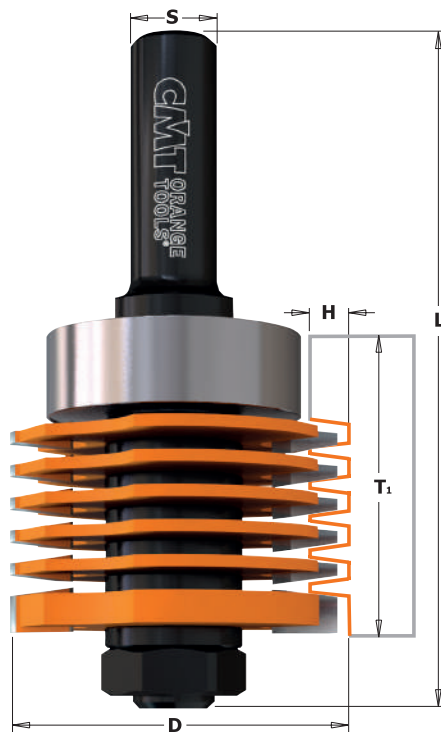

# Professional Finger Joint Bit

## 800.606



This versatile finger joint bit is the perfect tool for making incredibly strong side-to-side or end-to-end joints in wood and in varying lengths from 1/2" to 1-3/8". The tightness and accuracy of the cut joint coupled with the maximum glue surface create a joint that is actually stronger than an unworked piece of wood.

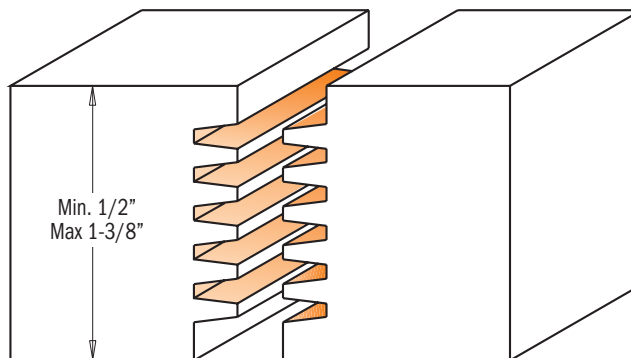

ORDER NO.		D		H	T <sub>1</sub>	L
S=Ø1/2" shank		inches	mm	inches	inches	inches
800.606.11	5	1-7/8	47.6	7/32	1/2 - 1-3/8	3-13/16

Spare parts			
824.129.00	791.028.00	822.005.11 5/4"	822.006.11 7/32"
			990.022.00

Spare parts: 541.511.00 3mm spacer  
 541.512.00 2mm spacer  
 541.526.00 0.1mm spacer  
 990.458.00 Kit with spacer

# Flute & Bead Set

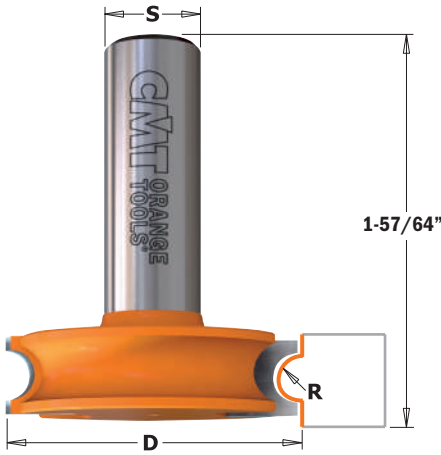

## 855.701

This perfectly mated CMT set is ideal for making wooden canoe slats and hot tub enclosures. The cutting edges in tungsten carbide stay sharp even after cutting large amounts of stock. The anti-kickback design ensures that you work safely. Use both the flute and the bead bits for 1/4" slats as shown below.

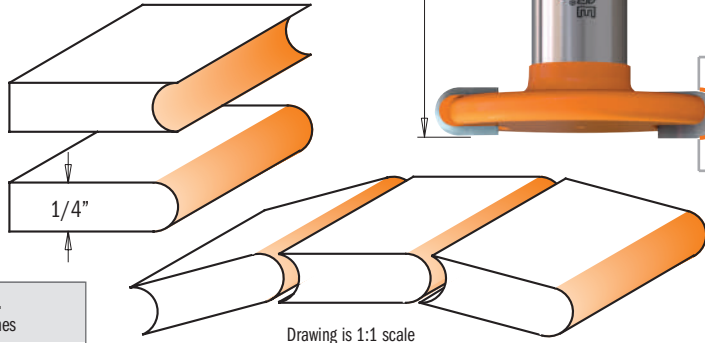

ORDER NO.		R	D	L
S=01/2" shank	5	inches mm	inches	inches
855.701.11	5	1/8 3.2	1-1/2	1-57/64 - 1-3/4

Drawing is 1:1 scale

# Lock Miter Set

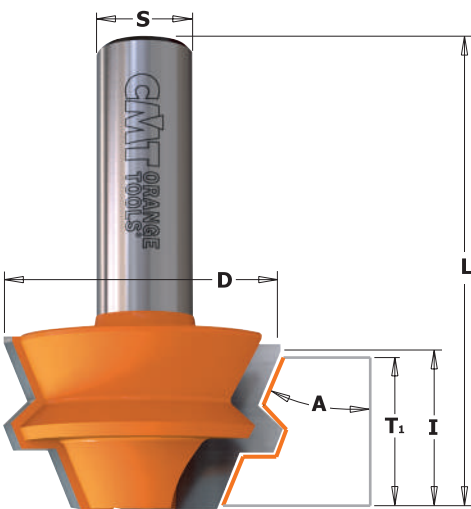

## 855

Use this pair of bits to produce octagonal shaped boxes and popular corner cabinetry for kitchens, kitchen islands, entertainment centres and corner hutches. This 22.5° Lock Miter set provides a strong tight joint even at 45° angles. After the joints are machined, they can be glued and assembled or simply clamped by using strapping tape.

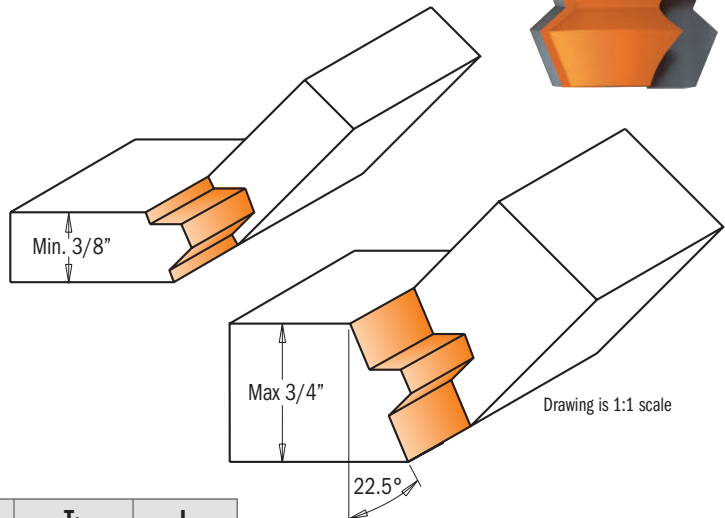
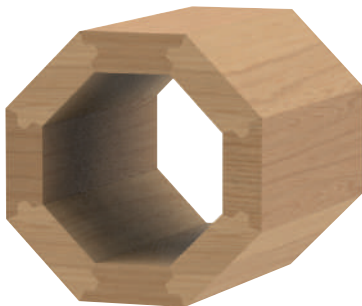

Drawing is 1:1 scale

ORDER NO.		D	I	A	T <sub>1</sub>	L
S=01/2" shank	5	inches mm	inches	degrees	inches	inches
855.505.11	5	1-15/32 37.3	7/8	22.5°	3/8 - 3/4	2-3/8

# Lock Miter Bits



**855.504**

These are the ultimate bits to craft sturdy miter joints thanks to anti-kickback design and tough tungsten carbide cutting edges.

By adding a second smaller bit, you can mill anywhere from 3/8" to 1-1/8" (9.52mm to 28.5mm) in thickness. A quick and easy way to accurately create boxes, stretcher bars, frames and any assortment of right angle or parallel joint projects.

You also have the advantage of using the same bit for parallel joinery projects.

To mill sturdy parallel glue joints follow step 1 shown in the illustration with the inside face of the workpiece laid flat on the table and centred to the bit. To make the second part, lay the workpiece flat on the table and centred to the bit. Mill with the inside face-up.

**855.503**

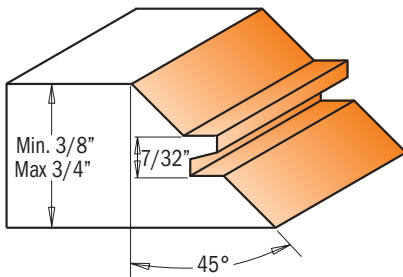

Drawing is 1:1 scale

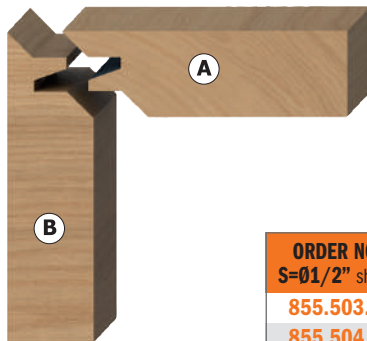
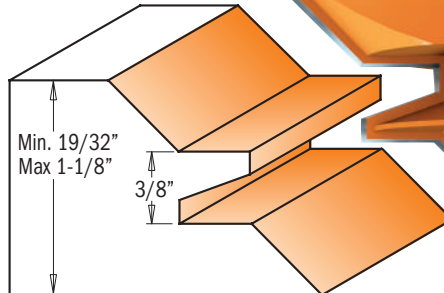

ORDER NO.		D	I	A	T <sub>1</sub>	L	
S=Ø1/2" shank		inches	mm	inches	inches	inches	
<b>855.503.11</b>	5	2-3/4	69.8	1-1/4	45°	5/8 - 1-1/8	2-3/4
<b>855.504.11</b>	5	2	50.8	7/8	45°	3/8 - 3/4	2-3/8

## MITER AND GLUE JOINTS WITH THE LOCK MITER BIT

Example shown below is made using Lock Miter Bit **855.503.11** and 3/4" stock.

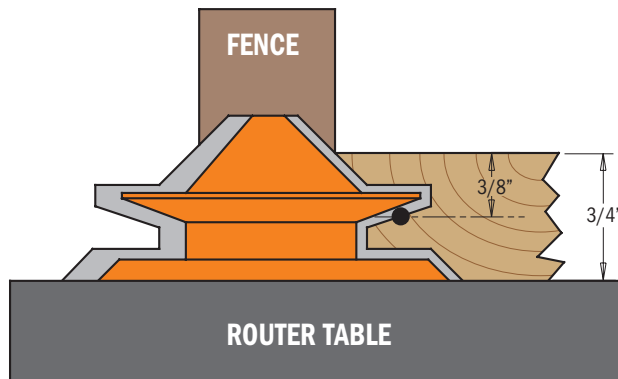

**Nr. 1:** Rout one piece with the inside face flat on the router table. Be sure the cut is centred to the stock.

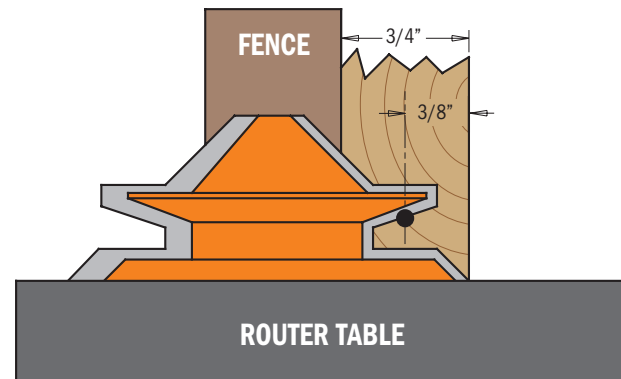

**Nr. 2:** Rout the second piece with the inside face vertical to the fence.



# Reverse Glue Joint Bits



## 855.501

The most unique and important characteristic of this CMT bit is its capacity to produce a virtually indestructible glue joint quickly and flawlessly. Ideal for routing panels, doors and furniture pieces of wide dimension, panels, doors and furniture pieces. Refer to page 202-203, "ABCs of Panel Door Construction".

By accurately centering the bit to the wood, the upper and lower vertical cutting edges of the bit will cut equal proportions. Simply run one edge of the panel, turn the panel over, and then run the opposite edge - you will craft perfectly harmonized reverse cuts that match up to produce immaculate joints!

**SHOP TIPS:** When glueing, apply enough pressure to securely seal the joint. Insufficient pressure results in a weak joint and excessive pressure will distort the wood.

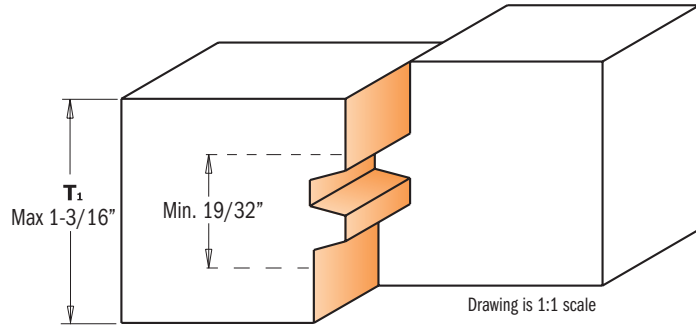
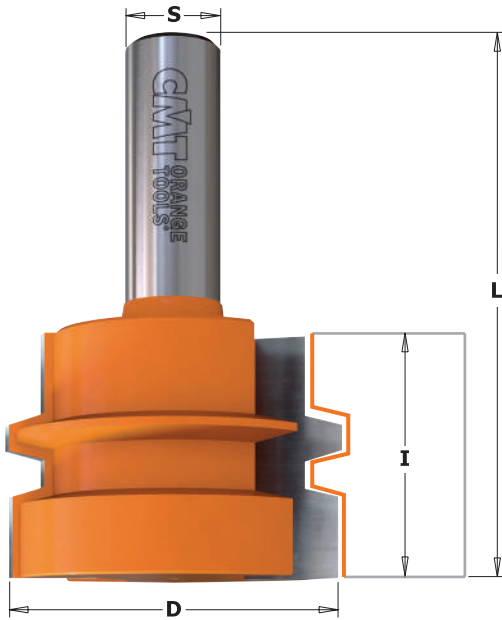

ORDER NO.			D		I	T <sub>1</sub>	L
S=01/2" shank		inches	inches	mm	inches	inches	inches
855.501.11	10	1-3/4	1-3/4	44.5	1-1/4	19/32 - 1-3/16	2-49/64

### IN THIS EXAMPLE WE USED A 3/4" BOARD

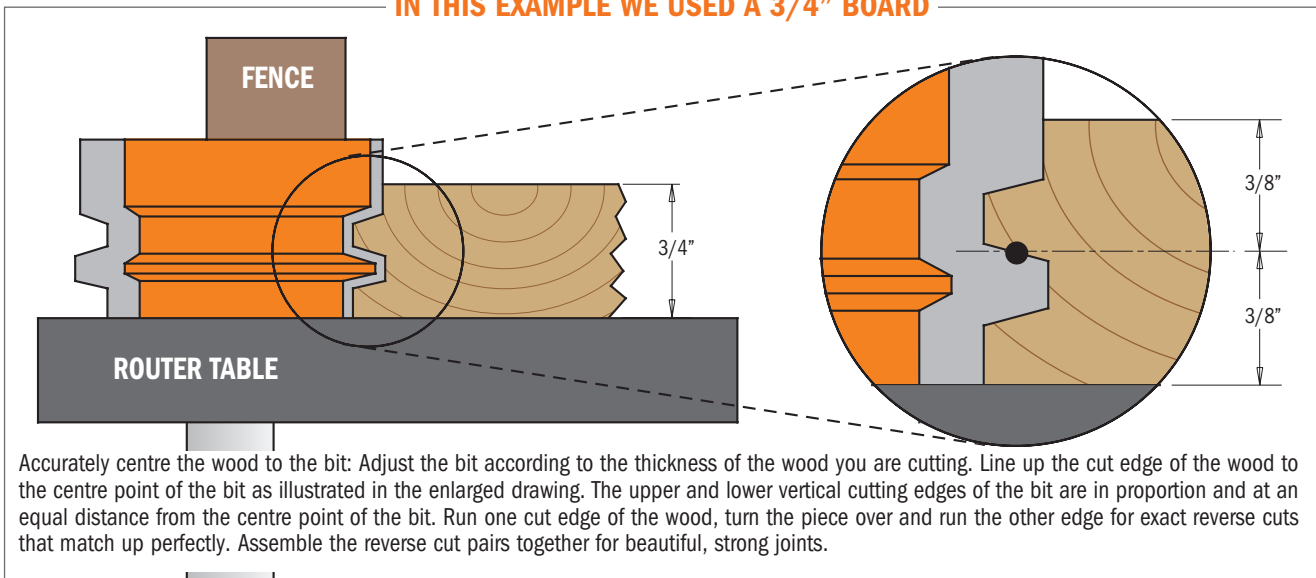

Accurately centre the wood to the bit: Adjust the bit according to the thickness of the wood you are cutting. Line up the cut edge of the wood to the centre point of the bit as illustrated in the enlarged drawing. The upper and lower vertical cutting edges of the bit are in proportion and at an equal distance from the centre point of the bit. Run one cut edge of the wood, turn the piece over and run the other edge for exact reverse cuts that match up perfectly. Assemble the reverse cut pairs together for beautiful, strong joints.

# Drawer Lock Bits

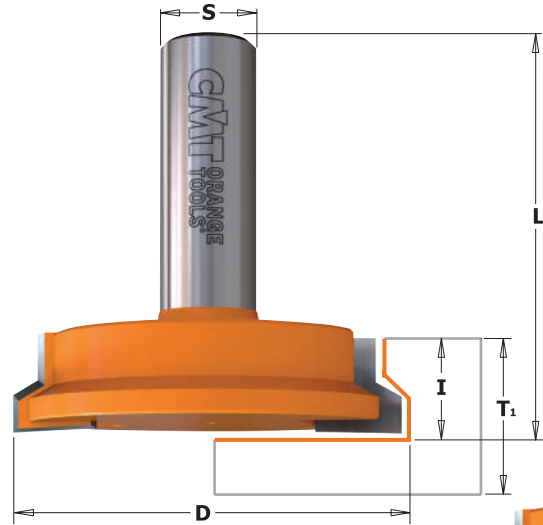

## 855



With CMT drawer lock bits you can make strong, perfectly fitted joints quickly and easily. Follow the example below to create perfect drawers.

**WARNING!** These bits are to be used on router tables only with a fence. Do not use on hand-held routers.

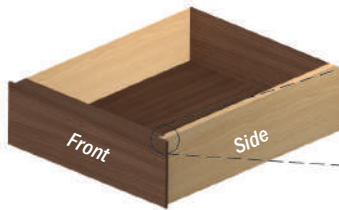
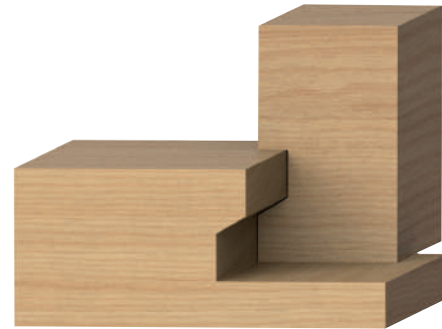
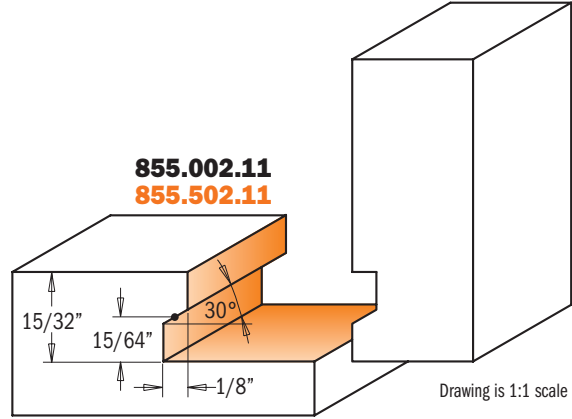
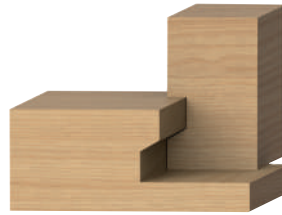
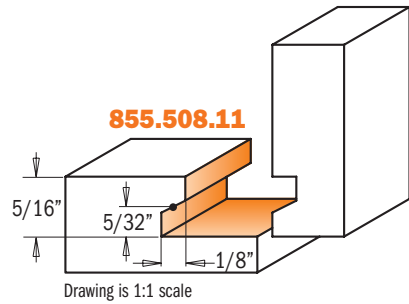

Overhang for drawer stop

ORDER NO. S=Ø1/4" shank	ORDER NO. S=Ø1/2" shank		D		T <sub>1</sub>		I	L
			inches	mm	min. inches	max inches	inches	inches
	<b>855.508.11</b>	10	1	25.4	3/8	5/8	1/2	2-1/8
<b>855.002.11</b>		10	1-1/4	31.7	5/8	1	1/2	1-3/4
	<b>855.502.11</b>	10	2	50.8	5/8	1	1/2	2

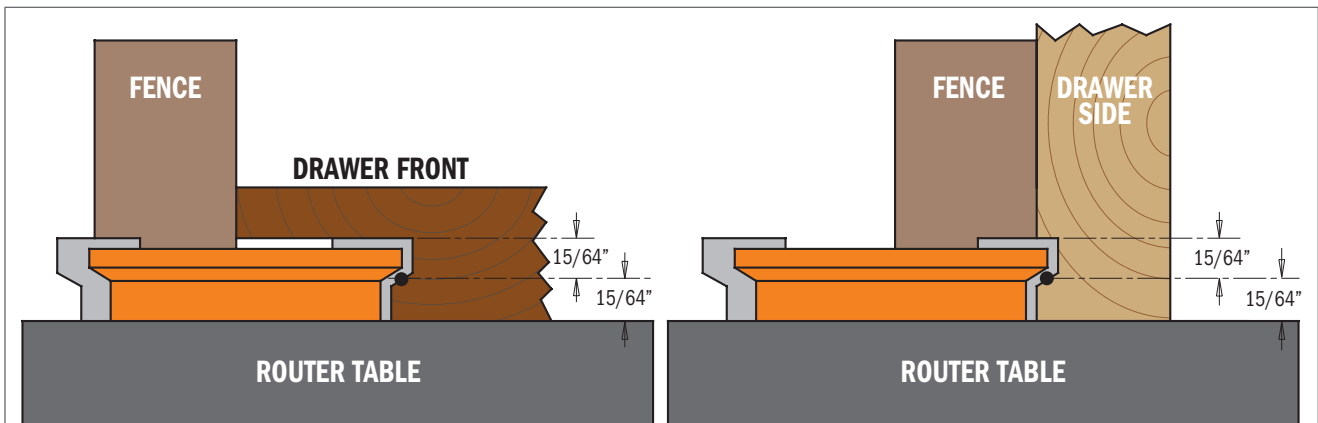

Mill the drawer front with the inside face down on the router table. Mill the sides of the drawer with the inside face of the workpiece placed vertically in relation to the bit and fence, and perpendicular to the table. Make a few test cuts on scrap stock to test your setup.  
**For use on router tables only. Not to be used with hand held routers.**

## Ovolo Sash Bits

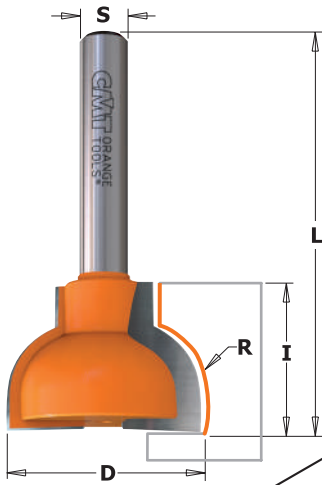

### 855.3

These bits allow you to make true divided light doors for fine furniture and cabinets as well as sash bar windows, and stile and rail constructions.

The glazing bar ovolo bits are bearing-guided to enable curved frames to be moulded.

Cove bits can be used to produce easy-to-pull drawer handles.

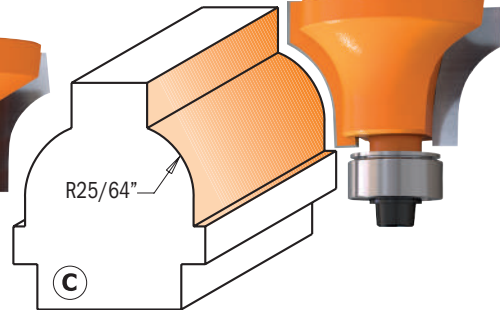
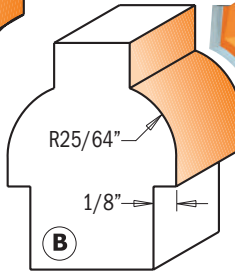
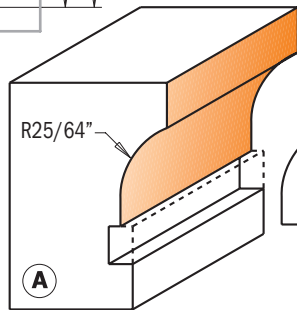

Drawing is 1:1 scale

ORDER NO.		D		I	R	L	PROFILE
S=Ø1/4" shank		inches	mm	inches	inches	inches	
855.307.11M	10	63/64	25	3/4	25/64	2	A
855.307.11F	10	7/8	22	3/4	25/64	2	B
855.308.11F	10	1-7/64	28	3/4	25/64	2-13/32	C

Spare parts

990.423.00	791.003.00	990.058.00	991.057.00

## Ovolo Sash Set

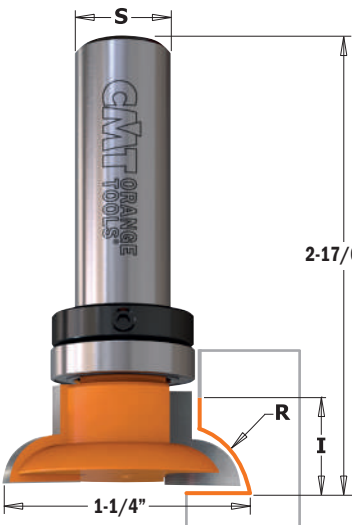

### 855.802

2-17/64"

2-25/64"

1-3/16"

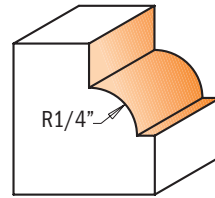
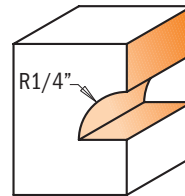

Drawing is 1:1 scale

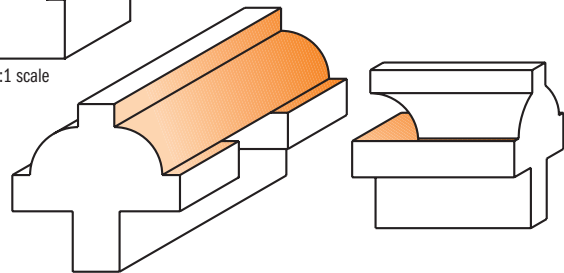

ORDER NO.		D		d	I	R
S=Ø1/2" shank		inches	mm	inches	inches	inches
855.802.11	5	1-1/4	31.7	1-3/16	15/32	1/4

Spare parts

990.423.00	791.003.00	990.058.00	991.057.00	791.011.00	541.002.00

Spare parts: 991.056.00 1.5mm hex key

# Window Sash Set

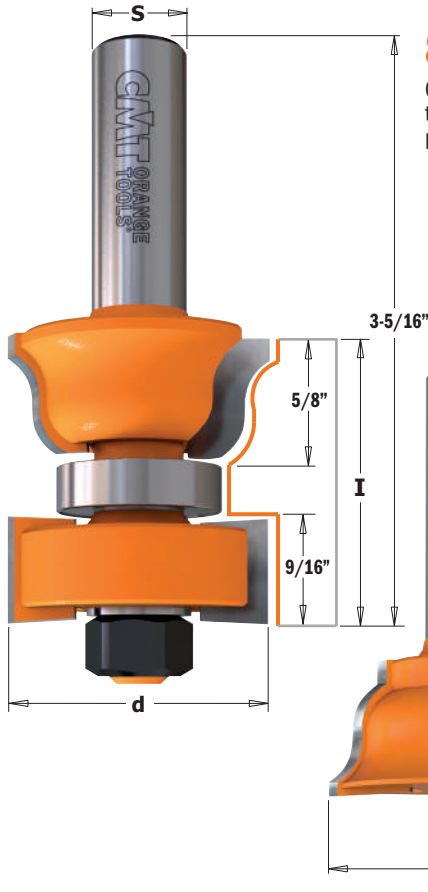

## 855.801

CMT designed this set so you can create window sashes that are as beautiful as they are functional. You can craft perfect 1/2" profiles for custom doors.

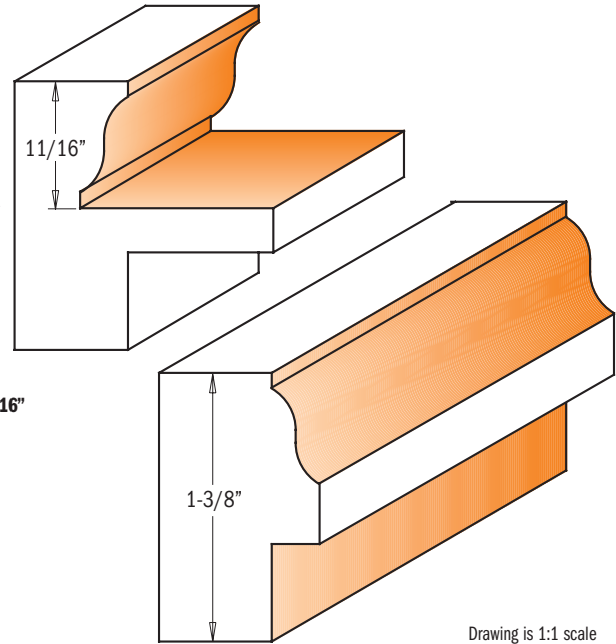

ORDER NO.		D	d	l	L	
S=01/2" shank	inches	mm	inches	inches	inches	
855.801.11	5	1-1/2	38.1	1-3/8	1-3/8	3-5/16 - 2-3/16

### Spare parts

791.012.00	822.004.11	541.518.00	990.020.00

## STEP-BY-STEP WINDOW SASH CONSTRUCTION

### CMT set makes it easy!

In our step-by-step example for window sash construction, we used the following:

- CMT Window Sash Set (item #855.801.11)
- stiles cut 1-3/8" thick
- rails cut 1-3/8" thick
- scrap stock

The CMT Window Sash Set was designed ideally for the construction of windows in 1-3/8" stock, however variations as narrow as 28mm can be used. Stock thicker than 1-3/8" exceeds the milling range of the cutter. Remember to adjust your measurements and cutting depths according to the wood thickness you use. We suggest making a trial joint in scrap stock according to the following steps before milling all of the cope and stick Profiles.

**STEP 1 - Measurements and making the tenons.** The ideal thickness of the stiles when using the CMT sash set is 1-3/8". The desired width of the stiles will determine the length you need to make your tenons, while the length of the stile will represent the desired full height of the sash. When cutting the rails to length, make sure to add the length of the two tenons to the overall length of the rail. The length of the tenons should be at least half the width of the stile. Mill 16mm measuring from the front face of the stock using a table saw, radial saw or router as shown in illustration 1. This measurement remains invariable since it is calculated to the height of the CMT sash routers. The width of the tenon is 6mm. Rotate the stock and mill the other side. As per our example, the second milling will be 13mm but this measurement will vary if you are using thinner stock.

**STEP 2 - Making the cope Profilee on rails, sash bar and muntins.** To make the cope Profilee, place the rail face front down on the router table with the tenon flush to the bit as shown in illustration 2. Adjust the fence so the bit mills 1/4" deeper than the tenon. To mill the sash bar and the muntins (cross bars), position front face down on the router table and mill without changing the height of the bit.

**STEP 3 - Making the stick Profilee on rails, stile, sash bar and muntins.** To mill the stick Profilee along the inside edges of all sash parts, place the already milled cope Profilee front face down on the router table and adjust the sash bit so that the lower edge of the top cutter will exactly touch the upper edge of the tenon as shown in need to 3 illustrations. With the rail still face down on the table, turn it so the inside edge of the rail is touching the bit and mill the stick Profilee. Mill the inside edges of the stiles and mill both edges of the front face of the sash bar and muntins. To cut the slots for the tenons, measure 16mm from the front face of the stiles and rout with a table saw.

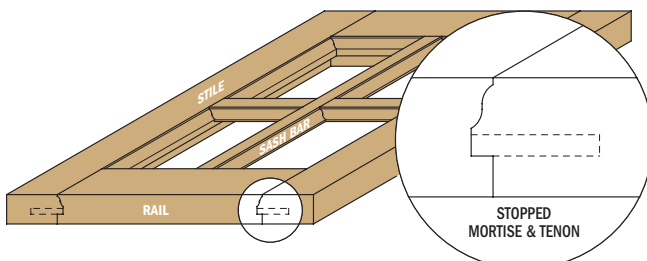
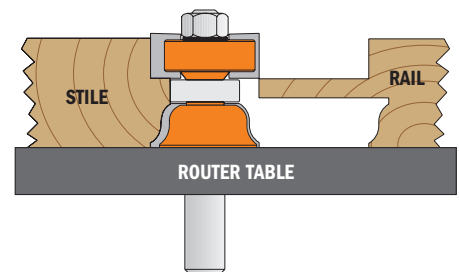
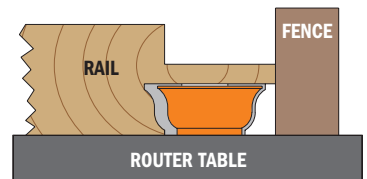
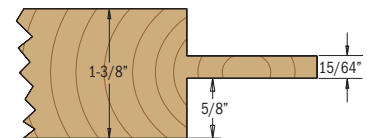



# Dovetail Bits

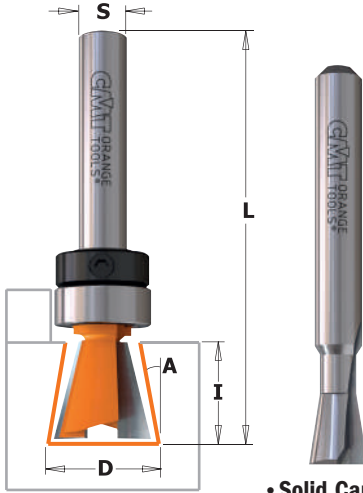

• Solid Carbide

## 818 - 818B



The beautifully crafted dovetail joint is a classic that appeals to both professionals and novices alike.

**SHOP TIPS:** Two passes are recommended when routing dovetails with a template. Check that the dovetails have been cut through completely and smoothly before removing the workpiece. For even easier routing and less stress on your dovetail bit, run the first pass with a straight bit. Use a dovetail on your router table equipped with a fence to achieve difficult chamfer angles.

**SAFETY TIPS:** If the dovetail bit jams while working, adjust the position of the bit in the collet and ensure the cutting depth is appropriate. Do not lift the router out of the template.

Drawing is 1:1 scale

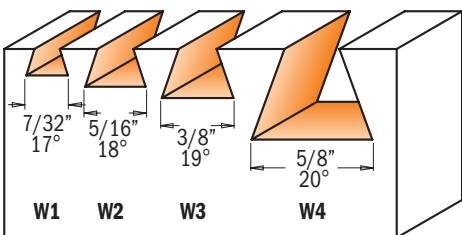
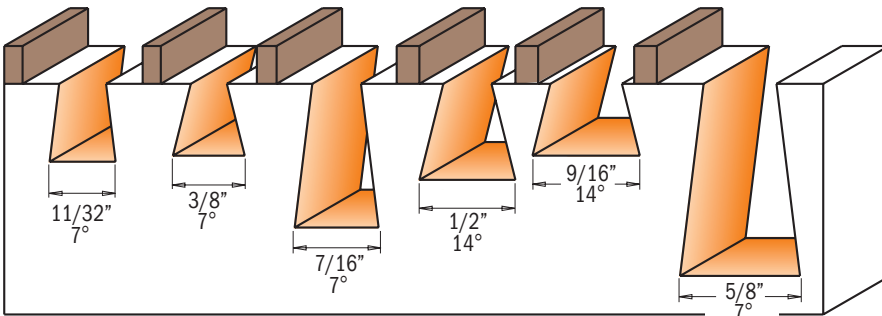
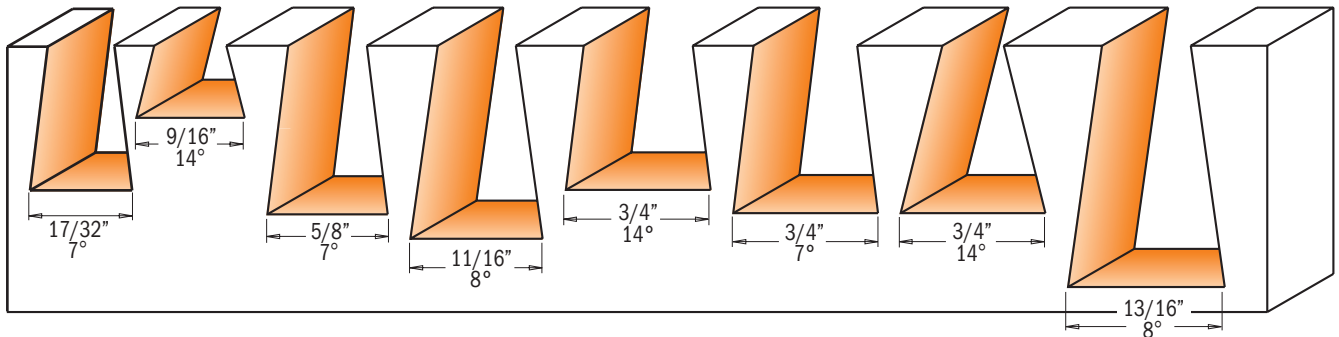
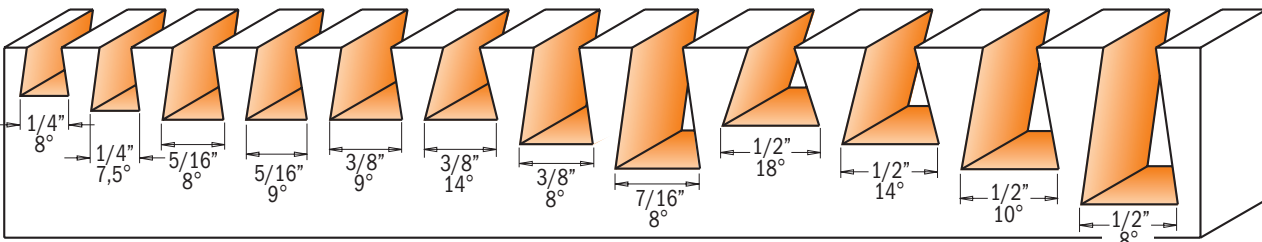

FIT HOFFMANN® KEYS

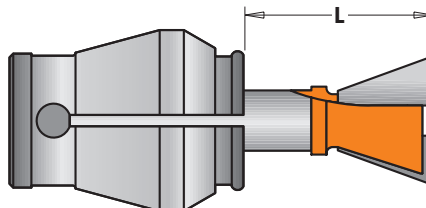

Fit Manufacturer Model	ORDER NO.
CMT-Enlock10	818.098.11B
CMT-Enlock15	818.128.11B
CMT300	818.128.11 818.628.11

Manufacturer/Model FIT HOFFMANN® KEYS	ORDER NO.
W1 L=16mm	818.053.11
W2 L=17.5mm	818.079.11
W3 L=19mm	818.093.11

# Dovetail Bits

ORDER NO. S=Ø1/4" shank	ORDER NO. S=Ø1/2" shank		D		I	A	L	APPLICATION
			inches	mm	inches		inches	
• 818.065.11		10	1/4	6.35	1/4	8°	2	For Leigh Jig
• 818.064.11	• 818.564.11	10	1/4	6.35	5/16	7.5°	2-1/2	For Incra Jig
• 818.081.11		10	5/16	7.94	3/8	8°	2-1/8	For Leigh Jig
• 818.080.11		10	5/16	7.94	3/8	9°	2-1/16	For Incra Jig
	• 818.580.11	10	5/16	7.94	3/8	9°	2-1/2	For Incra Jig
• 818.096.11		10	3/8	9.52	3/8	9°	2-1/16	For Incra Jig
	818.596.11	10	3/8	9.52	3/8	9°	2-1/2	For Incra Jig
• 818.098.11		10	3/8	9.52	3/8	14°	2-3/8	
818.097.11		10	3/8	9.52	1/2	8°	2-3/8	For Leigh Jig
818.111.11		10	7/16	11.1	5/8	8°	2-3/8	For Leigh Jig
818.132.11		10	1/2	12.7	13/32	18°	2-3/8	For Leigh Jig
818.128.11		10	1/2	12.7	1/2	14°	2-1/16	For Incra Jig
	818.628.11	10	1/2	12.7	1/2	14°	2-1/2	For Incra Jig
818.130.11		10	1/2	12.7	1/2	14°	2-7/16	For Leigh Jig
818.133.11		10	1/2	12.7	5/8	10°	2-3/8	For Leigh Jig
818.129.11		10	1/2	12.7	13/16	8°	2-3/4	For Leigh Jig
	818.635.11	10	17/32	13.5	3/4	7°	2-27/64	For PORTER-CABLE®
818.142.11		10	9/16	14.2	3/8	14°	2	
818.158.11		10	5/8	15.87	7/8	7°	2-3/8	For Incra Jig
	818.658.11	10	5/8	15.87	7/8	7°	2-5/8	For Incra Jig
	818.674.11	10	11/16	17.4	1	8°	3-1/16	For Leigh Jig
	818.691.11	10	3/4	19.05	3/4	14°	3-1/16	
818.190.11		10	3/4	19.05	7/8	7°	2-3/8	For Incra Jig
	818.690.11	10	3/4	19.05	7/8	7°	2-5/8	For Incra Jig
818.191.11		10	3/4	19.05	7/8	14°	2-3/8	
	818.706.11	10	13/16	20.6	1-1/4	8°	3-5/16	For Leigh Jig
	818.722.11	10	7/8	22.2	7/8	7°	2-3/4	
WITH TOP BEARING GUIDE								
• 818.087.11B		10	11/32	8.73	13/32	7°	2-1/4	
• 818.098.11B		10	3/8	9.52	3/8	14°	2-3/8	For CMT-Enlock1
818.113.11B		10	7/16	11.1	3/4	7°	2-5/8	
818.128.11B		10	1/2	12.7	1/2	14°	2-1/16	For CMT-Enlock1
818.142.11B		10	9/16	14.2	3/8	14°	2	
*With top bearing (Ø3/8" shank)								
818.159.11B*		10	5/8	15.87	1	7°	2-11/16	For HOFFMANN®
• 818.053.11		10	7/32	5.5	5/32	17°	1-11/16	For HOFFMANN® W1
• 818.079.11		10	5/16	7.94	15/64	18°	1-11/16	For HOFFMANN® W2
• 818.093.11		10	3/8	9.52	9/32	19°	1-11/16	For HOFFMANN® W3

## 818



Spare parts

791.009.00	541.001.00
791.010.00	541.001.00
791.009.00	541.001.00
791.010.00	541.001.00
791.010.00	541.001.00
791.021.00	541.006.00

Spare parts: 990.005.00 M3x3mm TSEI screw  
991.056.00 1.5mm hex key

• Solid Carbide



### A FEW OF THE BEAUTIFUL DOVETAIL JOINTS YOU CAN PRODUCE USING CMT BITS

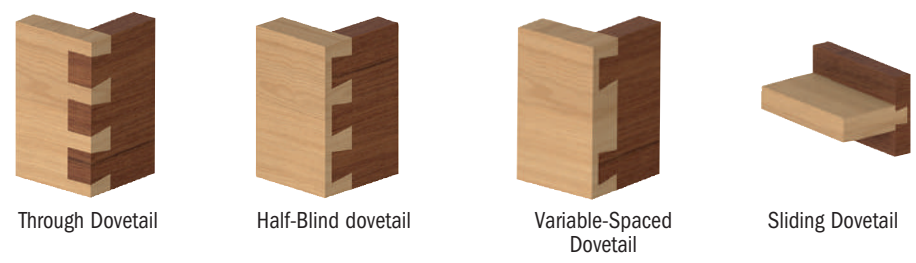

# V-Tongue & Groove Set

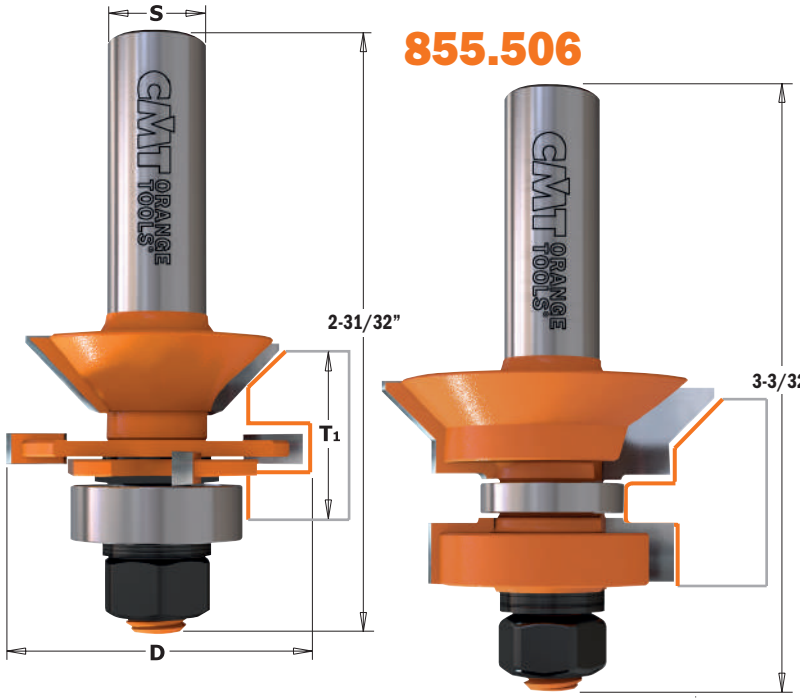

**855.506**



If the standard selection of moulding and mill work you find in today's lumber shops isn't satisfactory to your woodworking tastes, then consider CMT's moulding system instead. With these bits, you can make dozens of elaborate profiles by combining two or more passes. Avoid the average and create your own mouldings. Some initial suggestions are illustrated below.

**SAFETY TIPS:** use these bits with a fence. The profiles shown below are milled from heavy stock then refined to the desired shape.

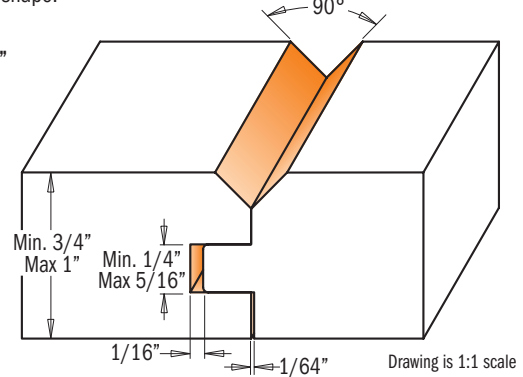

ORDER NO.		inches	D	mm	T <sub>1</sub>
<b>855.506.11</b>	<b>10</b>	1-3/4		44.5	3/4 - 1

*Spare parts*

	8mm		4mm		3/4"		7/8"		990.020.00
822.013.11		822.014.11		791.011.00		791.005.00			

Spare parts: **541.515.00** 0.1mm spacer      **541.517.00** 0.5mm spacer  
**541.516.00** 0.3mm spacer              **990.407.00** Shield

# Edge Banding Bits Set

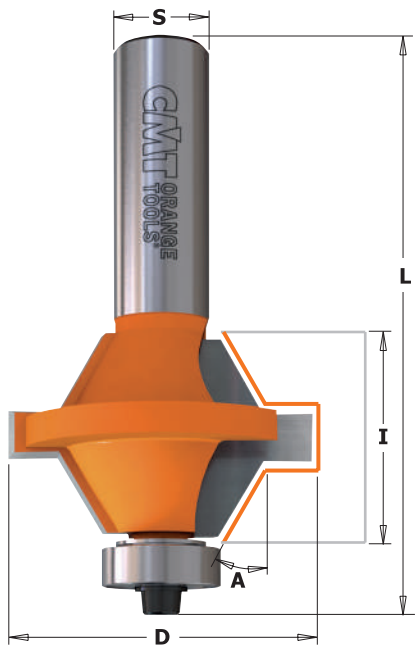

**855.510**



This is a great set to create cost-effective, yet attractive durable edges to your cabinet doors. For use with 1/2" or 1" thick panels in plywood or MDF. Easy to use: center each cutter on the stock and make the cut; glue the two pieces together; flush trim after assembly, if necessary. The set features a 60° angle tongue & groove with an ample surface area for glue application.

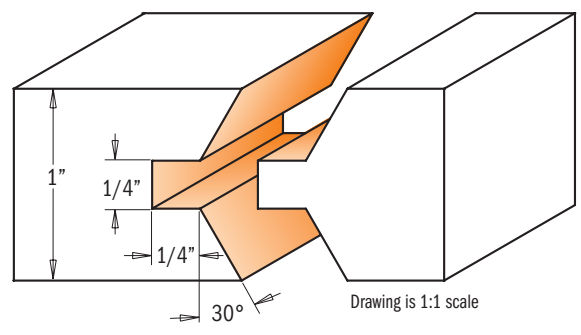

Drawing is 1:1 scale

ORDER NO.		inches	D	mm	I	A	L
<b>855.510.11</b>	<b>5</b>	1-37/64		40	1	30°	2-15/16

*Spare parts*

990.423.00	791.018.00	990.058.00	991.057.00

# 60° Lettering Bit

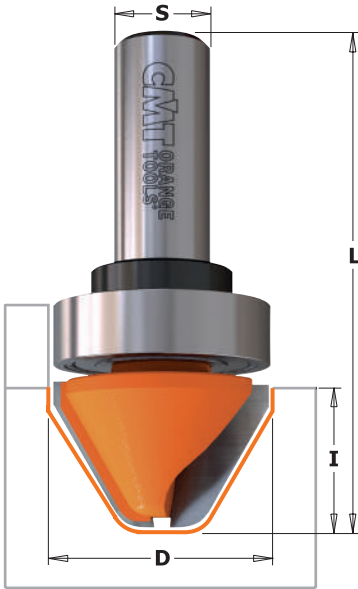

**849B**

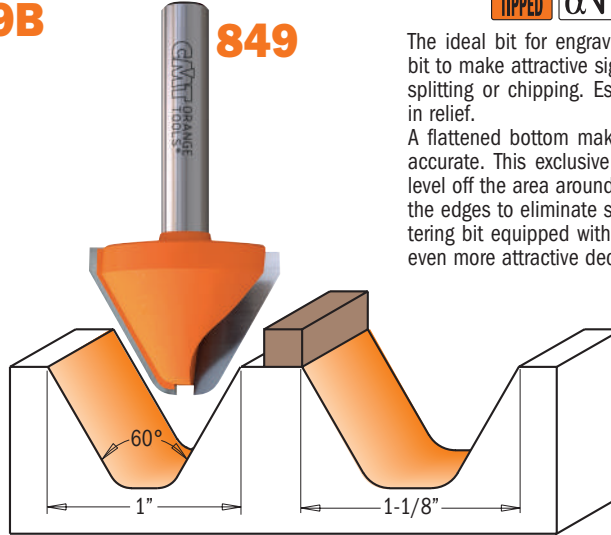

**849**



The ideal bit for engraving in wood, CMT designed this bit to make attractive signage without running the risk of splitting or chipping. Especially useful for letter carving in relief.

A flattened bottom makes relief letter-making easy and accurate. This exclusive design allows you to efficiently level off the area around the base of the letter and level the edges to eliminate splintering. Try our 60° angle lettering bit equipped with a top bearing guide to produce even more attractive decorative effects.

Drawing is 1:1 scale

ORDER NO. S=01/4" shank	ORDER NO. S=01/2" shank		D		I	A	L
			inches	mm	inches		inches
<b>849.001.11</b>		10	1	25.4	3/4	60°	2
	<b>849.501.11</b>	10	1-1/8	28.5	3/4	60°	2-1/2
WITH TOP BEARING GUIDE							
	<b>849.501.11B</b>	10	1-1/8	28.5	3/4	60°	2-1/2

Spare parts

791.027.00	541.002.00	991.056.00

Spare parts: 990.005.00 M3x3mm STEI screw

# Bowl & Tray Bits



**851B**



**851**



This CMT bit is ideal for making bowls, trays, boxes, cutting boards or any other specialty or craft item. The round corner of the bit shapes the inner radius while the sides and bottom create the smooth flat surfaces. We recommend using a top bearing for accurate and easy pattern work.

**TIPS:** use these bits on a table router with bearing guide for decorative edgework.

Drawing is 1:1 scale

ORDER NO. S=01/4" shank	ORDER NO. S=01/2" shank		D		I	R	L
			inches	mm	inches	inches	inches
<b>851.001.11</b>		10	7/16	11.1	1/2	1/8	1-51/64
<b>851.002.11</b>		10	3/4	19.05	5/8	1/4	2-1/8
	<b>851.501.11</b>	10	3/4	19.05	5/8	1/4	2-3/8
	<b>851.502.11</b>	10	1-1/4	31.7	5/8	1/4	2-3/8
WITH TOP BEARING GUIDE							
<b>851.002.11B</b>		10	3/4	19.05	5/8	1/4	2-1/8
	<b>851.501.11B</b>	10	3/4	19.05	5/8	1/4	2-3/8
	<b>851.502.11B</b>	10	1-1/4	31.7	5/8	1/4	2-3/8

Spare parts

791.004.00	541.001.00	991.056.00
791.011.00	541.002.00	991.056.00
791.015.00	541.002.00	991.056.00

Spare parts: 990.005.00 M3x3mm STEI screw



# V-Grooving Bits (90°)

SOLID CARBIDE CARBIDE TIPPED T2 RH

## 815 - 815B

These double cutting edge CMT bits offer an almost endless range of woodworking possibilities. Make clean, perfect cuts in panels, drawer fronts or even plasterboard panels; chamfer edges or engrave beautiful lettering. In addition, CMT has versatile top bearing bits that allow for several template options of your choice (see series **815B**).

**TIPS:** these bits perfectly chamfer at 45° angles (Two tools in one).

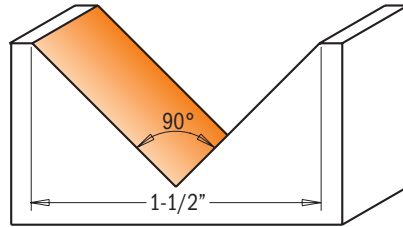

Drawing is 1:1 scale

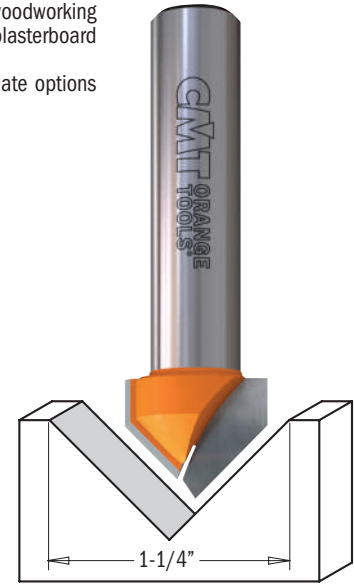
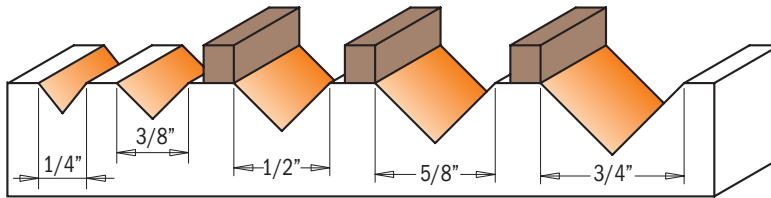

PLASTERBOARD PANEL

ORDER NO.	ORDER NO.		D		I	I <sub>1</sub>	A	L
S=Ø1/4" shank	S=Ø1/2" shank		inches	mm	inches	inches		inches
• 815.064.11		10	1/4	6.35	5/16	1/8	90°	1-1/2
815.095.11		10	3/8	9.52	1/2	3/16	90°	1-3/4
815.127.11		10	1/2	12.7	1/2	1/4	90°	1-3/4
	815.660.11	10	5/8	15.87	1/2	5/16	90°	2-1/2
	815.690.11	10	3/4	19.05	5/8	3/8	90°	2-1/2
	815.817.11	10	1-1/4	31.7	3/4	5/8	90°	2-1/2
	815.880.11	10	1-1/2	38.1	1-1/8	3/4	90°	2-3/4
WITH TOP BEARING GUIDE								
815.127.11B		10	1/2	12.7	1/2	1/4	90°	1-3/4
	815.690.11B	10	3/4	19.05	5/8	3/8	90°	2-1/2

Spare parts

791.010.00	541.001.00	991.056.00
791.011.00	541.002.00	991.056.00

• Solid Carbide

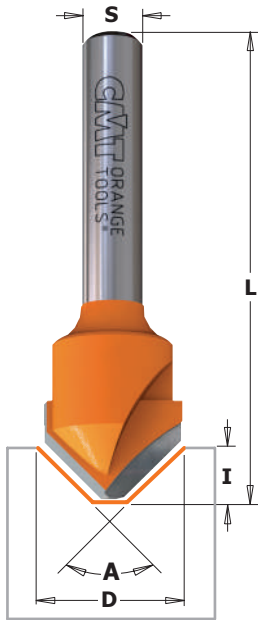

## 815

CARBIDE TIPPED T2 RH

ALUCOBOND® panels are an aluminium composite material that can be shaped using a very simple processing method. This technique referred to as the 'routing and folding' method which means paneling can be manipulated to form a variety of shapes and sizes. The advantages of this unique technique are:

- Low investment cost
- Simple fabrication technique
- Folding can be done on site, saving transportation costs
- Low-cost fabrication of shaped components, wall cladding, roof edgings, column cladding, flashings, etc.
- Flexibility in creating shapes
- Very cost effective
- Shapes are not limited by machine capacity.

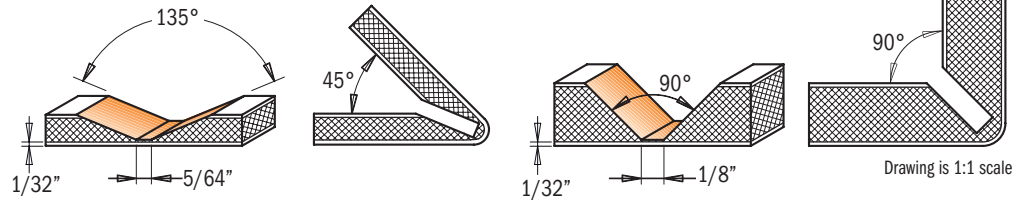

ORDER NO.		D	I	A	L
S=01/4" shank		inches	mm	inches	inches
815.001.11	10	45/64	18	90°	2-23/64
815.002.11	10	45/64	18	135°	2-23/64

# Laser Point Bit



## 858

SOLID CARBIDE CARBIDE TIPPED T1 T2 T3 RH

This bit crafts delicate grooves and incisions with laser precision. Make one-of-a-kind effects with 30° bevel edges in one single run. Equipped with three super sharp cutting edges, this perfectly balanced bit allows you to work with incredible accuracy with no risk of burning. Raise the bit and produce a delicate fine point incision, or work the whole 1/2" (12.7mm) diameter to render bold highlighted lettering. Super strong steel shank and micrograin carbide cutting edges guarantee long lasting performance.

858.002.11  
• Solid Carbide

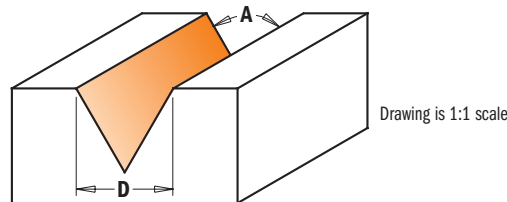

ORDER NO.	ORDER NO.		D	I	A	T	L
S=01/4" shank	S=01/2" shank		inches	mm	inches		inches
• 858.002.11		10	1/4	6.35	3/8	35°	2
858.001.11		10	1/2	12.7	7/16	60°	2-1/4
	858.501.11	10	1/2	12.7	7/16	60°	2-3/8
858.003.11		10	1/2	12.7	25/64	60°	2

# V-Grooving & Signmaking Router Bits with indexable knives (90°)



## 665

These bits have been designed for signmaking and lettering. When the insert shows signs of wear, you can simply rotate it to exploit the other cutting edges. A locking screw secures the insert tightly for added safety and extreme cutting accuracy.

### TECHNICAL DETAILS:

- Super strength steel.
- 1 T.C.T. precision insert knife [T1].

### SAFETY TIPS:

The **TW-006** Torque Screwdriver is recommended for the proper fastening of screws (see page 267).



### CORRECT KNIFE POSITIONING

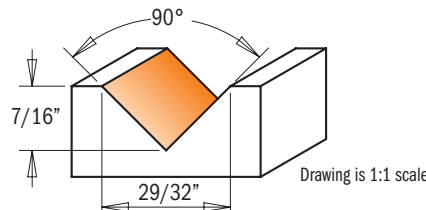
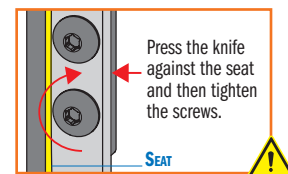

ORDER NO.		D	I	A	L
<b>665.201.11</b>	<b>10</b>	inches 29/32 mm 23	inches 7/16	90°	inches 2-3/8

### Spare parts

790.280.00	990.093.00	991.073.00

# Chamfer Bits with Insert Knives

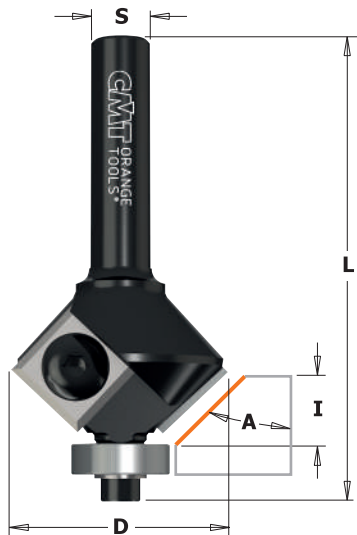

## 659

Chamfer trim bits feature two replaceable knives fixed by special TORX® screws. The knives are sharpened on all sides and can be resharpened up to three times. For slight bevelled edges or decorative edgework in a variety of materials. Equipped with bearing guides with no need for counterprofiles. For use on portable routers.

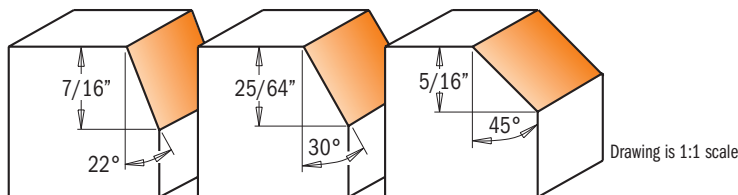

### SAFETY TIPS:

The **TW-006** Torque Screwdriver is recommended for the proper fastening of screws (see page 267).

### CORRECT KNIFE POSITIONING

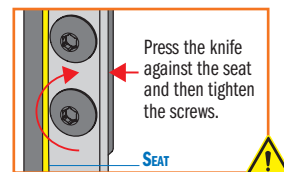

ORDER NO.	ORDER NO.		D	A	I	L
<b>659.023.11</b>	<b>S=01/2" shank</b>	<b>10</b>	inches 63/64 mm 25	22°	7/16	inches 2-15/32
<b>659.031.11</b>	<b>S=01/2" shank</b>	<b>10</b>	inches 1-7/64 mm 28	30°	25/64	inches 2-9/16
<b>659.046.11</b>	<b>S=01/2" shank</b>	<b>10</b>	inches 1-9/64 mm 29	45°	5/16	inches 2-13/32
	<b>659.646.11</b>	<b>10</b>	inches 1-9/64 mm 29	45°	5/16	inches 2-23/32

### Spare parts

790.120.00	990.075.00	791.006.00
790.120.00	990.075.00	791.006.00
790.120.00	990.075.00	791.022.00
790.120.00	990.075.00	791.022.00

Spare parts: **990.400.00** Ø3.2/Ø7mm shield for M3 screw

**990.051.00** M3x6mm TCEI screw

**991.062.00** 2.5mm hex key

**991.061.00** T15 TORX® key

# Chamfer Bits

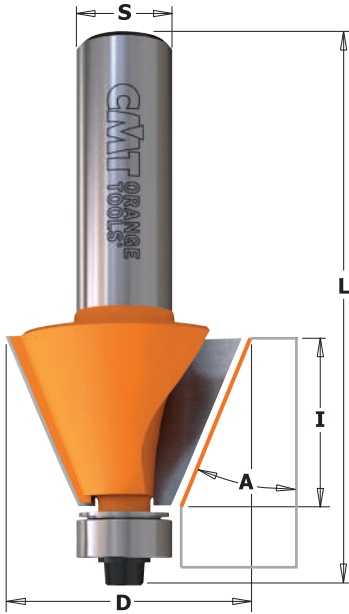

## 836 - 857

CMT chamfer bits can cut clean, accurate bevels and chamfers and are great for edge work or for making perfectly aligned multi-sided containers, boxes and other decorative projects. See illustration below for examples. Can be used for working larger scale projects such as beams and columns with excellent results.

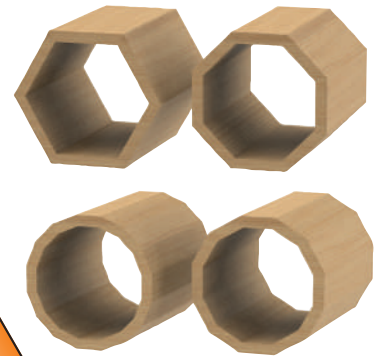
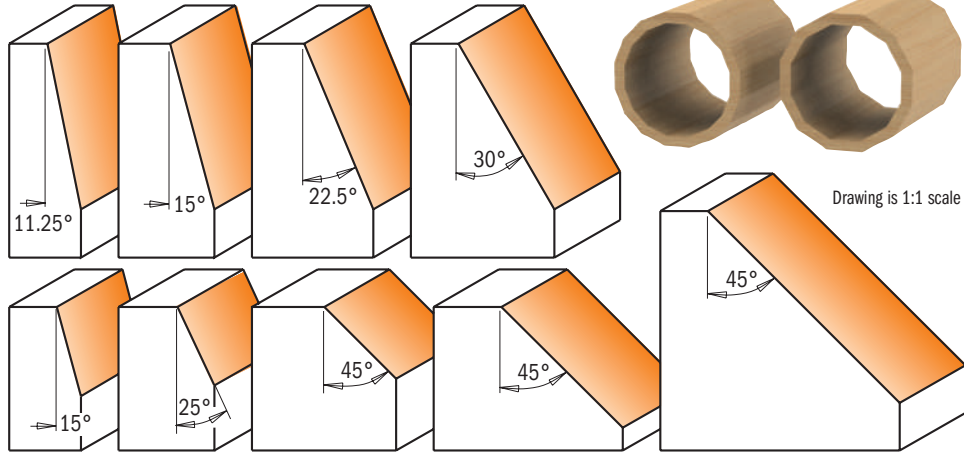

ORDER NO. S=Ø1/4" shank	ORDER NO. S=Ø1/2" shank		D	A	I	L	
			inches	mm	inches	inches	
836.130.11		10	3/4	19.05	15°	7/16	2-5/32
836.190.11		10	7/8	22.2	25°	13/32	2-5/32
836.280.11		10	1-1/4	31.7	45°	3/8	2-3/32
836.420.11		10	1-49/64	45	45°	23/32	2-3/8
	836.920.11	10	1-49/64	45	45°	23/32	2-5/8
	836.950.11	10	2-9/16	65	45°	1	3-1/32
	857.504.11	10	7/8	22.2	11.25°	7/8	2-13/16
	857.503.11	10	1	25.4	15°	7/8	2-13/16
	857.502.11	10	1-1/4	31.7	22.5°	7/8	2-13/16
	857.501.11	10	1-1/2	38.1	30°	7/8	2-13/16

### Spare parts

990.423.00	791.003.00	990.058.00	991.057.00
990.423.00	791.003.00	990.058.00	991.057.00
990.423.00	791.003.00	990.058.00	991.057.00
990.423.00	791.003.00	990.058.00	991.057.00
990.423.00	791.003.00	990.058.00	991.057.00
990.423.00	791.003.00	990.058.00	991.057.00
990.423.00	791.003.00	990.058.00	991.057.00
990.423.00	791.003.00	990.058.00	991.057.00
990.423.00	791.003.00	990.058.00	991.057.00
990.423.00	791.003.00	990.058.00	991.057.00

**SHOP TIPS:** After resharpening, replace bearing 791.003.11 (Ø12.7mm) with undersized bearing 791.063.00 (Ø12.5mm)



## Chamfer Set

### 836.501.11

1/2" Shank

SET CONTAINS	ORDER NO. S=Ø1/2" shank	D	A
		inches	mm
Chamfer bit	857.504.11	7/8	22.2
Chamfer bit	857.503.11	1	25.4
Chamfer bit	857.502.11	1-1/4	31.7
Chamfer bit	857.501.11	1-1/2	38.1
Chamfer bit	836.920.11	1-49/64	45

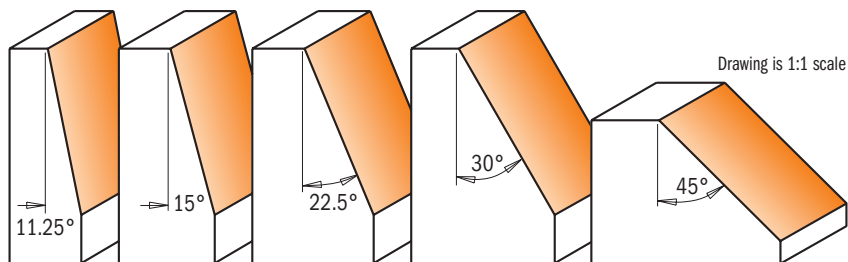

This set includes 5 anti-kickback carbide-tipped bits to make angled cuts and polygonal projects easier and more accurate in the most popular angles.



# Round Nose Bits



## 814B



Personalize your doors, drawer fronts, panels or any surface with your own signature motif. CMT round nose bits in solid carbide featuring carbide tipped flutes let you create delicate and decorative accents in any wood or wood derivative.

**SHOP TIPS:** more than one pass is recommended when making cove edges. To prevent splintering, begin with a shallow initial pass and deepen gradually. Never use pieces shorter than 600mm.



Drawing is 1:1 scale

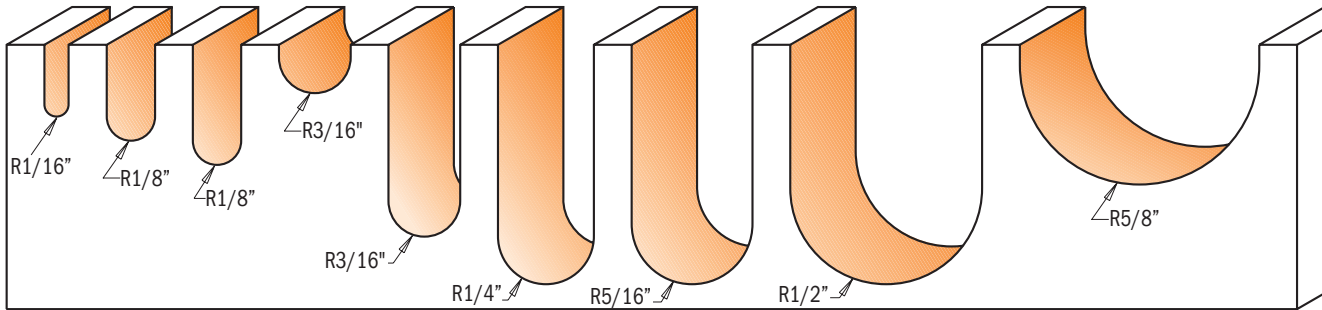
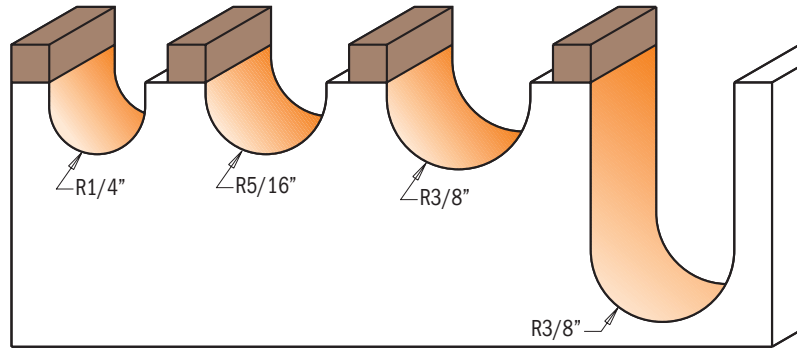

ORDER NO. S=Ø1/4" shank	ORDER NO. S=Ø1/2" shank		R		D	I	L
			inches	mm	inches	inches	inches
• 814.032.11		10	1/16	1.6	1/8	3/8	2
• 814.064.11		10	1/8	3.2	1/4	1/2	2
	• 814.564.11	10	1/8	3.2	1/4	5/8	2-1/2
814.095.11		10	3/16	4.75	3/8	1/4	2
	814.595.11	10	3/16	4.75	3/8	1	2-5/8
814.127.11		10	1/4	6.35	1/2	3/8	2
	814.627.11	10	1/4	6.35	1/2	1-1/4	2-7/8
814.160.11		10	5/16	7.94	5/8	3/8	2
	814.660.11	10	5/16	7.94	5/8	1-1/4	2-7/8
814.190.11		10	3/8	9.52	3/4	7/16	2
	814.690.11	10	3/8	9.52	3/4	1-1/4	2-7/8
	814.721.11	10	7/16	11	7/8	1	2-1/2
	814.754.11	10	1/2	12.7	1	1-1/4	2-7/8
	814.817.11	10	5/8	15.87	1-1/4	3/4	2-5/16
	814.880.11	10	3/4	19.05	1-1/2	1-1/4	2-3/4
	814.990.11	10	1	25.4	2	1-1/4	2-3/4
WITH TOP BEARING GUIDE							
814.127.11B		10	1/4	6.35	1/2	3/8	2
814.160.11B		10	5/16	7.94	5/8	3/8	2
814.190.11B		10	3/8	9.52	3/4	7/16	2
	814.690.11B	10	3/8	9.52	3/4	1-1/4	2-7/8

Spare parts: 990.005.00 M3x3mm TSEI screw  
991.056.00 1.5mm hex key

• Solid Carbide



Spare parts

791.010.00	541.001.00
791.009.00	541.001.00
791.004.00	541.001.00
791.011.00	541.002.00

# Ball End Bit

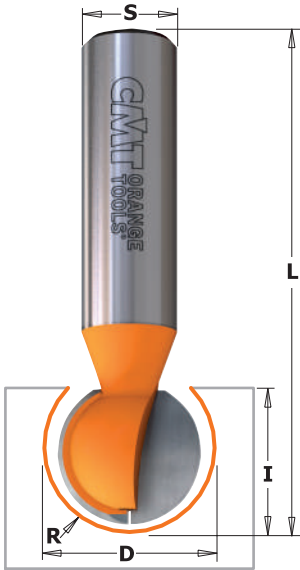

## 868

Cut channels for pipes or cables in one single pass using CMT's ball end bits. Reduce the stress on the bits by cutting a first groove with a straight bit.

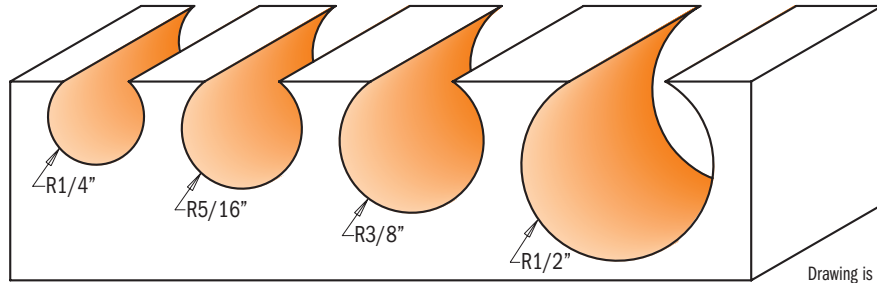

Drawing is 1:1 scale

ORDER NO.		R		D	I	L
S=Ø1/2" shank		inches	mm	inches	inches	inches
868.627.11	10	1/4	6.35	1/2	7/16	2-1/4
868.658.11	10	5/16	7.94	5/8	9/16	2-3/8
868.690.11	10	3/8	9.52	3/4	11/16	2-1/2
868.754.11	10	1/2	12.7	1	59/64	2-3/4

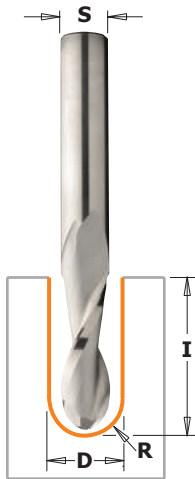

# Solid Carbide Upcut Ball Nose Spiral Bits

## 199

These new bits are used for ripping, template routing, panel sizing and any routing application in solid wood, wood composites, laminates, plastics, solid surface and aluminum. Can be used at a high feed speed on well-clamped workpieces, on machining centres, point to point machines, CNC routers and hand-held routers equipped with chucks or adaptors.



ORDER NO.		R		D	I	S	L
		inches	mm	inches	inches	inches	inches
199.001.11	10	1/16	1.6	1/8	1/2	1/4	2
199.008.11	10	1/8	3.2	1/4	1	1/4	2-1/2
199.504.11	10	3/16	4.75	3/8	1-1/8	3/8	3
199.505.11	10	1/4	6.35	1/2	1-1/4	1/2	3
199.509.11	10	5/16	7.94	5/8	2-1/4	5/8	4-5/16
199.511.11	10	3/8	9.52	3/4	2-1/4	3/4	4-5/16

# Round Nose Set



Each of these sets include 3 of the most widely used CMT Round Nose bits. These solid carbide or carbide tipped bits are perfect for sign making, engraving, or adding flutes and veins to doors or drawer fronts. Available in 1/4" and 1/2" shanks.

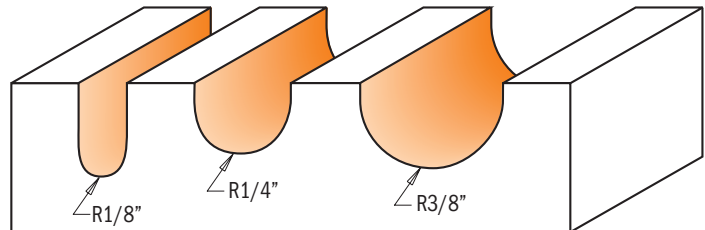

Drawing is 1:1 scale

## 814.001.11

1/4" Shank

SET CONTAINS	ORDER NO.	R		I
	S=Ø1/4" shank	inches	mm	inches
Round nose bit	814.064.11	1/8	3.2	1/2
Round nose bit	814.127.11	1/4	6.35	3/8
Round nose bit	814.190.11	3/8	9.52	7/16

## 814.501.11

1/2" Shank

SET CONTAINS	ORDER NO.	R		I
	S=Ø1/2" shank	inches	mm	inches
Round nose bit	814.564.11	1/8	3.2	5/8
Round nose bit	814.627.11	1/4	6.35	1-1/4
Round nose bit	814.690.11	3/8	9.52	1-1/4

# Cove Bits

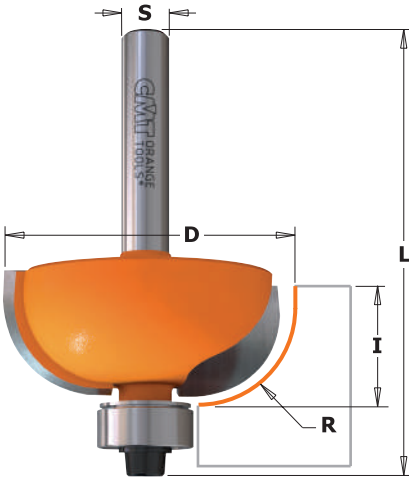

## 837

Make simple or elegant furniture, doors and drawer fronts by adding a final touch with CMT cove bits.

**TIPS:** rounded edges provide a very refined and elegant look.

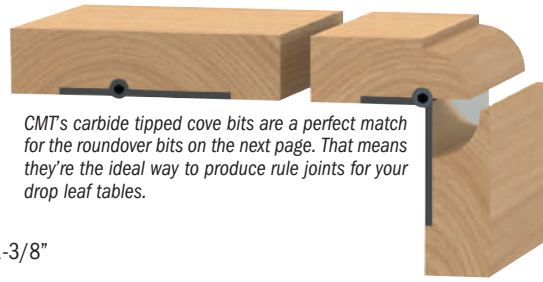

CMT's carbide tipped cove bits are a perfect match for the roundover bits on the next page. That means they're the ideal way to produce rule joints for your drop leaf tables.

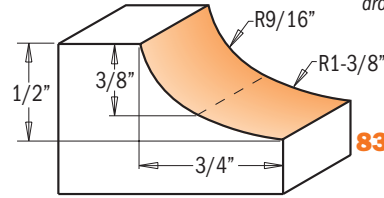

**837.955.11**

Drawing is 1:1 scale

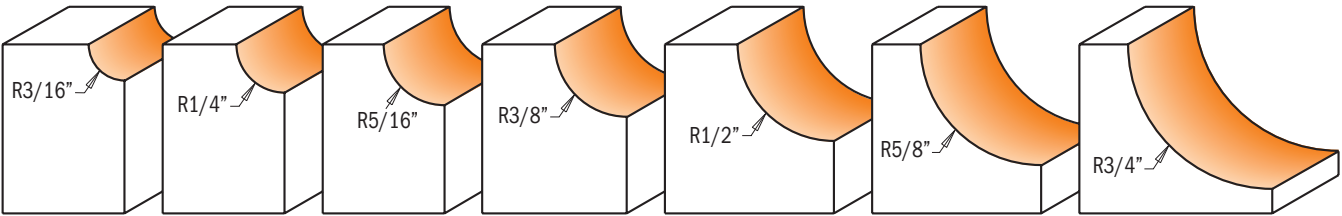

ORDER NO. S=Ø1/4" shank	ORDER NO. S=Ø1/2" shank		R		D	I	L
			inches	mm	inches	inches	inches
<b>837.190.11</b>		10	3/16	4.75	7/8	1/2	2-5/32
	<b>837.690.11</b>	10	3/16	4.75	7/8	1/2	2-13/32
<b>837.222.11</b>		10	1/4	6.35	1	1/2	2-5/32
	<b>837.722.11</b>	10	1/4	6.35	1	1/2	2-13/32
<b>837.254.11</b>		10	5/16	7.94	1-1/8	1/2	2-1/8
	<b>837.754.11</b>	10	5/16	7.94	1-1/8	1/2	2-3/8
<b>837.286.11</b>		10	3/8	9.52	1-1/4	1/2	2-1/8
	<b>837.786.11</b>	10	3/8	9.52	1-1/4	1/2	2-3/8
<b>837.350.11</b>		10	1/2	12.7	1-1/2	5/8	2-9/32
	<b>837.850.11</b>	10	1/2	12.7	1-1/2	5/8	2-17/32
	<b>837.950.11</b>	10	5/8	15.87	1-3/4	3/4	2-41/64
	<b>837.951.11</b>	10	3/4	19.05	2	7/8	2-25/32
	<b>837.955.11</b>	10	See drawing		2	1/2	2-13/32

### Spare parts

990.423.00	791.003.00	990.058.00	991.057.00
990.423.00	791.003.00	990.058.00	991.057.00
990.423.00	791.003.00	990.058.00	991.057.00
990.423.00	791.003.00	990.058.00	991.057.00
990.423.00	791.003.00	990.058.00	991.057.00
990.423.00	791.003.00	990.058.00	991.057.00
990.423.00	791.003.00	990.058.00	991.057.00
990.423.00	791.003.00	990.058.00	991.057.00
990.423.00	791.003.00	990.058.00	991.057.00
990.423.00	791.003.00	990.058.00	991.057.00
990.423.00	791.003.00	990.058.00	991.057.00
990.423.00	791.003.00	990.058.00	991.057.00
990.423.00	791.003.00	990.058.00	991.057.00
990.423.00	791.003.00	990.058.00	991.057.00

# Cove Bit Set



See simple furniture, doors and drawer fronts transform into elegant pieces by giving them a final touch with a CMT Cove Bit. Available with 1/4", 3/8" and 1/2" radius bits of your choice or 1/4" or 1/2" shank.

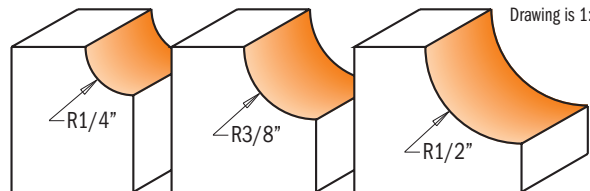

Drawing is 1:1 scale

## 837.001.11

1/4" Shank

SET CONTAINS	ORDER NO. S=Ø1/4" shank	R		I
		inches	mm	inches
Cove bit	<b>837.222.11</b>	1/4	6.35	1/2
Cove bit	<b>837.286.11</b>	3/8	9.52	1/2
Cove bit	<b>837.350.11</b>	1/2	12.7	5/8

## 837.501.11

1/2" Shank

SET CONTAINS	ORDER NO. S=Ø1/2" shank	R		I
		inches	mm	inches
Cove bit	<b>837.722.11</b>	1/4	6.35	1/2
Cove bit	<b>837.786.11</b>	3/8	9.52	1/2
Cove bit	<b>837.850.11</b>	1/2	12.7	5/8

# Cavetto Edge Mould Bits

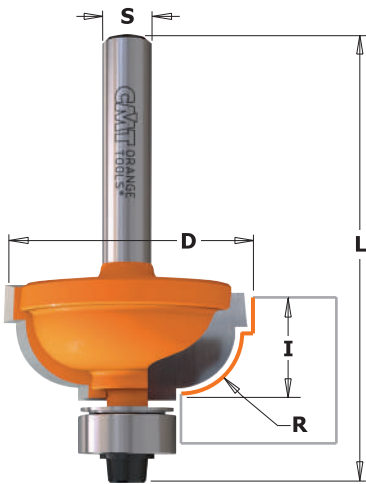

## 863 - 864



The cavetto bit cuts beautiful, traditional profiles, but you may also use just a portion of the bit to cut a more simple and cleaner cove edge.

**SAFETY TIPS:** poor assembly may lead to unscrewing and loss of the bearing during operation.

**SHOP TIPS:** after resharpening, replace bearing as follow:  
 791.002.00 (Ø9.5mm) with undersized bearing **791.062.00** (Ø9.3mm)  
 791.003.00 (Ø12.7mm) with undersized bearing **791.063.00** (Ø12.5mm)

Drawing is 1:1 scale

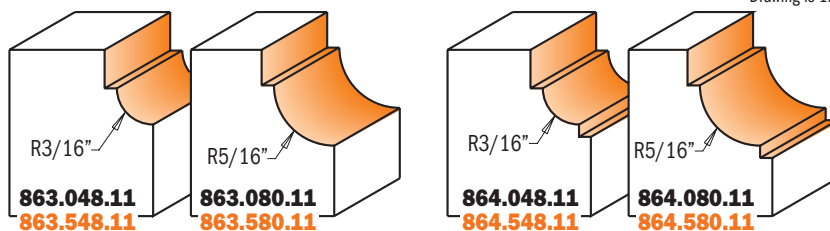

ORDER NO. S=Ø1/4" shank	ORDER NO. S=Ø1/2" shank		R		D	I	L
			inches	mm	inches	inches	inches
<b>863.048.11</b>		10	3/16	4.76	1	29/64	2-1/8
	<b>863.548.11</b>	10	3/16	4.76	1	29/64	2-3/8
<b>863.080.11</b>		10	5/16	7.94	1-1/4	9/16	2-1/4
	<b>863.580.11</b>	10	5/16	7.94	1-1/4	9/16	2-15/32
<b>864.048.11</b>		10	3/16	4.76	1	29/64	2-3/32
	<b>864.548.11</b>	10	3/16	4.76	1	29/64	2-5/16
<b>864.080.11</b>		10	5/16	7.94	1-1/4	9/16	2-5/32
	<b>864.580.11</b>	10	5/16	7.94	1-1/4	9/16	2-13/32

### Spare parts

990.423.00	791.003.00	990.058.00	991.057.00
990.423.00	791.003.00	990.058.00	991.057.00
990.423.00	791.003.00	990.058.00	991.057.00
990.423.00	791.003.00	990.058.00	991.057.00
990.422.00	791.002.00	990.058.00	991.057.00
990.422.00	791.002.00	990.058.00	991.057.00
990.422.00	791.002.00	990.058.00	991.057.00
990.422.00	791.002.00	990.058.00	991.057.00

# Ovolo Bits

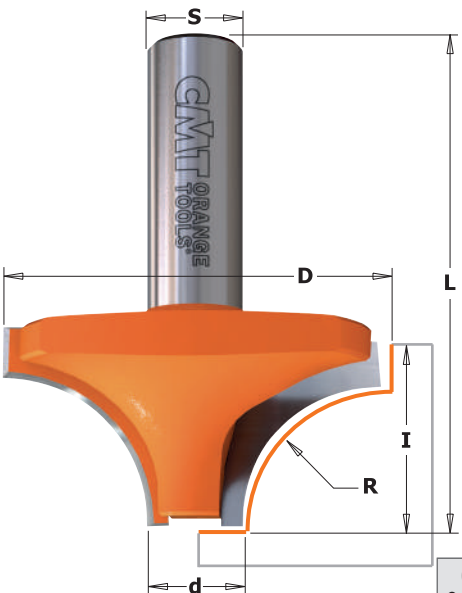

## 827

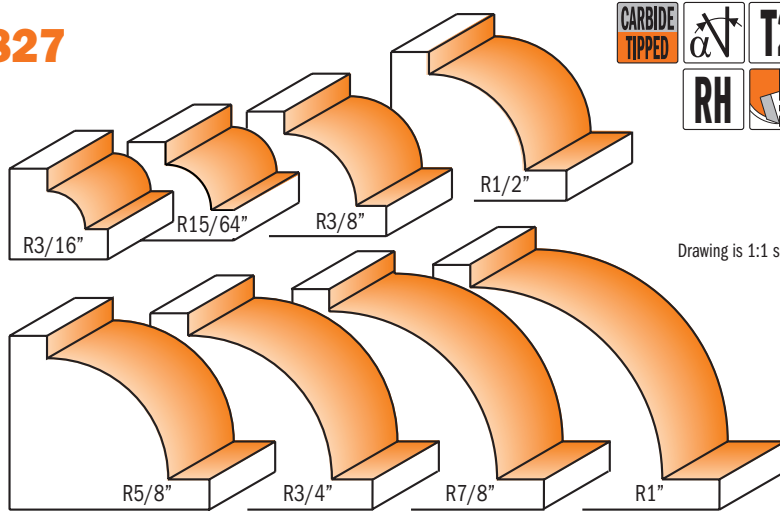

Drawing is 1:1 scale

ORDER NO. S=Ø1/4" shank	ORDER NO. S=Ø1/2" shank		R		d	D	I	L
			inches	mm	inches	inches	inches	inches
<b>827.050.11</b>		10	3/16	5	7/16	13/16	15/32	1-23/32
<b>827.060.11</b>		10	15/64	6	7/16	29/32	15/32	1-23/32
	<b>827.560.11</b>	10	15/64	6	7/16	29/32	15/32	1-31/32
<b>827.095.11</b>		10	3/8	9.52	1/2	1-1/4	5/8	1-7/8
	<b>827.595.11</b>	10	3/8	9.52	1/2	1-1/4	5/8	2-1/8
<b>827.127.11</b>		10	1/2	12.7	1/2	1-1/2	3/4	2
	<b>827.627.11</b>	10	1/2	12.7	1/2	1-1/2	3/4	2-1/4
	<b>827.660.11</b>	10	5/8	15.87	1/2	1-3/4	7/8	2-3/8
	<b>827.690.11</b>	10	3/4	19.05	1/2	2	1	2-1/2
	<b>827.722.11</b>	10	7/8	22.2	1/2	2-1/4	1-1/8	2-5/8
	<b>827.754.11</b>	10	1	25.4	1/2	2-1/2	1-5/16	2-13/16

The perfect bit for furniture makers, the CMT ovolo allows you to make beautiful beadwork, edgework and veins as well as a wide variety of single and double bead profiles and roundovers.

**SAFETY TIPS:** pay particular attention to never rush the job when using a large profile bit. Mill pieces with a fence mounted on the work table to ensure maximum protection.



# Roundover Bits

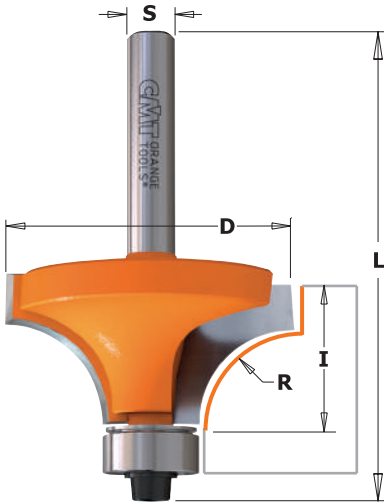

## 838



All CMT roundover bits provide a wide variety of profiles to create beautiful decorative edgework on furniture or boats. Lower the bit to expose the straight part of the cutting edge in this way you can apply a decorative edge to tables, shelves and beams.

**SHOP TIPS:** use the 1.6mm radius roundover bit for finishing laminates. A simple height adjustment helps save time on finishing.

**SAFETY TIPS:** use caution when working with large diameter bits and make more than one pass to gradually remove stock.

**SHOP TIPS:** after resharpening, replace bearing 791.003.11 (Ø12.7mm) with undersized bearing **791.063.00** (Ø12.5mm)

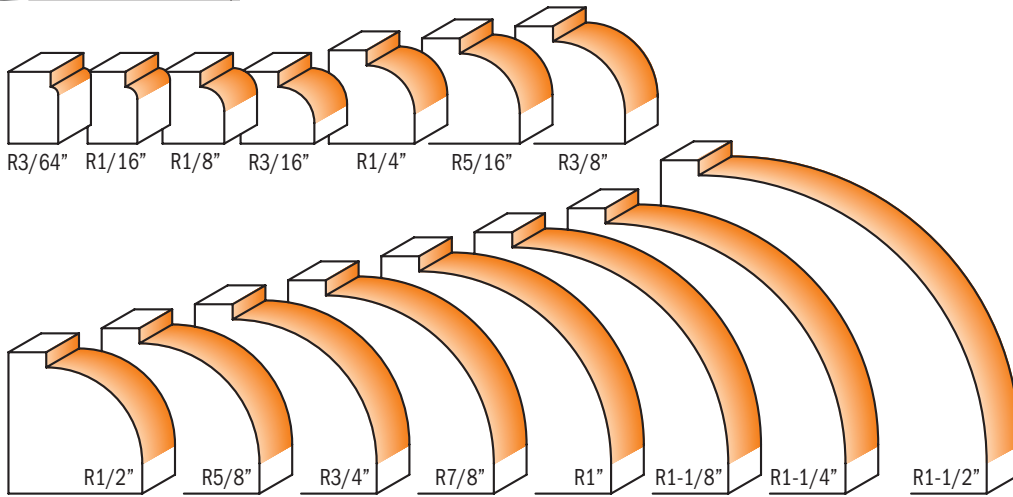

Drawing is 1:1 scale

ORDER NO. S=Ø1/4" shank	ORDER NO. S=Ø1/2" shank		R	D	I	L	Spare parts				
			inches	mm	inches	inches					
838.147.11°		10	3/64	1	37/64	3/8	2	990.422.00	791.044.00	990.058.00	991.057.00
838.160.11		10	1/16	1.6	5/8	1/2	2-9/64	990.423.00	791.003.00	990.058.00	991.057.00
838.167.11		10	5/64	2	21/32	1/2	2-5/64	990.422.00	791.044.00	990.058.00	991.057.00
838.187.11		10	1/8	3	47/64	1/2	2-1/8	990.423.00	791.003.00	990.058.00	991.057.00
838.190.11		10	1/8	3.2	3/4	1/2	2-9/64	990.422.00	791.044.00	990.058.00	991.057.00
838.222.11		10	3/16	4.75	7/8	1/2	2-9/64	990.423.00	791.003.00	990.058.00	991.057.00
838.254.11		10	1/4	6.35	1	1/2	2-9/64	990.423.00	791.003.00	990.058.00	991.057.00
	838.754.11	10	1/4	6.35	1	1/2	2-5/16	990.423.00	791.003.00	990.058.00	991.057.00
838.285.11		10	5/16	7.94	1-1/8	1/2	2-9/64	990.423.00	791.003.00	990.058.00	991.057.00
838.317.11		10	3/8	9.52	1-1/4	5/8	2-1/4	990.423.00	791.003.00	990.058.00	991.057.00
	838.817.11	10	3/8	9.52	1-1/4	5/8	2-7/16	990.423.00	791.003.00	990.058.00	991.057.00
838.380.11		10	1/2	12.7	1-1/2	3/4	2-25/64	990.423.00	791.003.00	990.058.00	991.057.00
	838.880.11	10	1/2	12.7	1-1/2	3/4	2-41/64	990.423.00	791.003.00	990.058.00	991.057.00
838.445.11		10	5/8	15.87	1-3/4	7/8	2-1/2	990.423.00	791.003.00	990.058.00	991.057.00
	838.945.11	10	5/8	15.87	1-3/4	7/8	2-3/4	990.423.00	791.003.00	990.058.00	991.057.00
	838.990.11	10	3/4	19.05	2	1	2-57/64	990.423.00	791.003.00	990.058.00	991.057.00
	838.991.11	10	7/8	22.2	2-1/4	1-1/8	3-1/32	990.423.00	791.003.00	990.058.00	991.057.00
	838.992.11*	10	1	25.4	2-1/2	1-5/16	3-13/64	990.423.00	791.003.00	990.058.00	991.057.00
	838.993.11*	10	1-1/8	28.6	3	1-1/2	3-1/2	990.425.00	791.004.00	990.058.00	991.057.00
	838.994.11*	10	1-1/4	31.7	3-1/4	1-3/4	3-49/64	990.425.00	791.004.00	990.058.00	991.057.00
	838.996.11*	10	1-1/2	38.1	3-1/2	1-3/4	3-41/64	990.423.00	791.003.00	990.058.00	991.057.00

Spare parts: 541.550.00 1.6mm spacers (838.993.11 and 838.994.11)

\*For use on router tables only

°791.044.00 DELRIN® Bearing

# Beading Bits

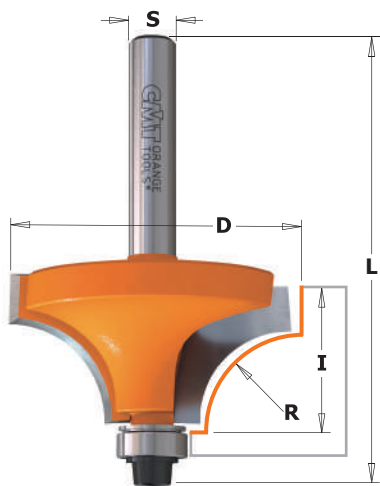

**839**



If you want to create a delicate inset at the base of the cut of a roundover profile, simply switch the bearing normally used for making profiles **838** (listed on the following page) to the undersized one listed below (**791.002.00**).

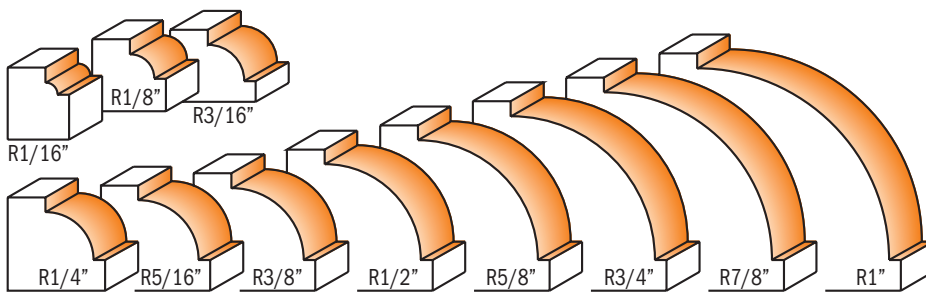

Drawing is 1:1 scale

ORDER NO. S=01/4" shank	ORDER NO. S=01/2" shank	Box	R		D inches	I inches	L inches	Spare parts			
			inches	mm				Washer	Washer	Pin	Hex Key
839.160.11		10	1/16	1.6	5/8	1/2	2-1/16	990.422.00	791.002.00	990.058.00	991.057.00
839.190.11		10	1/8	3.2	3/4	1/2	2-1/16	990.422.00	791.002.00	990.058.00	991.057.00
839.222.11		10	3/16	4.75	7/8	1/2	2-1/16	990.422.00	791.002.00	990.058.00	991.057.00
839.254.11		10	1/4	6.35	1	1/2	2-1/16	990.422.00	791.002.00	990.058.00	991.057.00
	839.754.11	10	1/4	6.35	1	1/2	2-5/16	990.422.00	791.002.00	990.058.00	991.057.00
839.285.11		10	5/16	7.94	1-1/8	1/2	2-1/16	990.422.00	791.002.00	990.058.00	991.057.00
839.317.11		10	3/8	9.52	1-1/4	5/8	2-3/16	990.422.00	791.002.00	990.058.00	991.057.00
	839.817.11	10	3/8	9.52	1-1/4	5/8	2-7/16	990.422.00	791.002.00	990.058.00	991.057.00
839.380.11		10	1/2	12.7	1-1/2	3/4	2-5/16	990.422.00	791.002.00	990.058.00	991.057.00
	839.880.11	10	1/2	12.7	1-1/2	3/4	2-9/16	990.422.00	791.002.00	990.058.00	991.057.00
839.445.11		10	5/8	15.87	1-3/4	7/8	2-7/16	990.422.00	791.002.00	990.058.00	991.057.00
	839.945.11	10	5/8	15.87	1-3/4	7/8	2-11/16	990.422.00	791.002.00	990.058.00	991.057.00
	839.990.11	10	3/4	19.05	2	1	2-13/16	990.422.00	791.002.00	990.058.00	991.057.00
	839.991.11	5	7/8	22.2	2-1/4	1-1/8	2-15/16	990.422.00	791.002.00	990.058.00	991.057.00
	839.992.11*	5	1	25.4	2-1/2	1-5/16	3-1/8	990.422.00	791.002.00	990.058.00	991.057.00

\*For use on router tables only.

# Roundover Set



CMT's roundover sets give you the maximum flexibility for all of your projects by putting the most requested diameters in one package. Available in 1/2" and 1/4" shanks. Roundover radii are 1/4", 3/8" and 1/2". These versatile bits are always in demand - the simple clean lines of a smooth roundover edge can be used in a wide variety of applications from picture frames to table and counter tops.

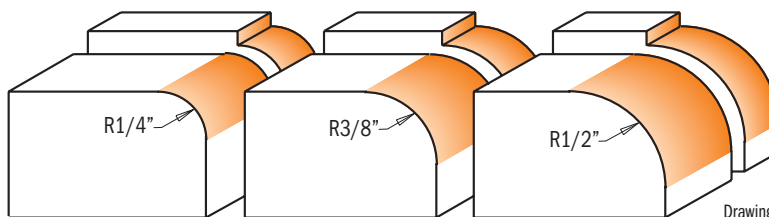

Drawing is 1:1 scale

**838.001.11**

**1/4" Shank**

SET CONTAINS	ORDER NO. S=01/4" shank	R		I
		inches	mm	inches
Roundover bit	838.254.11	1/4	6.35	1/2
Roundover bit	838.317.11	3/8	9.52	5/8
Roundover bit	838.380.11	1/2	12.7	3/4

**838.501.11**

**1/2" Shank**

SET CONTAINS	ORDER NO. S=01/2" shank	R		I
		inches	mm	inches
Roundover bit	838.754.11	1/4	6.35	1/2
Roundover bit	838.817.11	3/8	9.52	5/8
Roundover bit	838.880.11	1/2	12.7	3/4

# Roundover Bits with Insert Knives



## 661.41

Roundover bits with two replaceable knives fixed by special TORX® screws. The blades are profiled on 4 sides and increase the efficiency of your work with laminates and chipboard, as well as hard and soft woods. For use on portable routers.

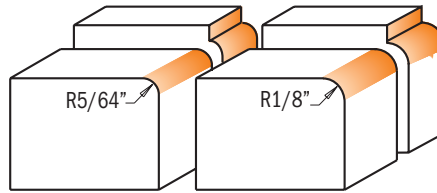

Drawing is 1:1 scale

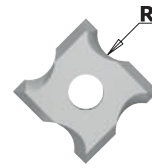

**Standard**  
R=1/8" 790.030.04

**Optional**  
R=3/64" 790.010.04  
R=1/16" 790.015.04  
R=5/64" 790.020.04

### SAFETY TIPS:



The **TW-006** Torque Screwdriver is recommended for the proper fastening of screws (see page 267).

### CORRECT KNIFE POSITIONING

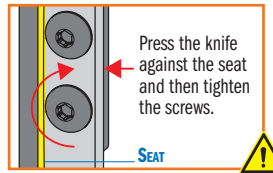

ORDER NO.	Box	R	D	I	L
<b>S=Ø1/4" shank</b>		inches	mm	inches	inches
661.021.41	10	5/64	2	57/64	49/64
661.031.41	10	1/8	3	1/2	1/8

### Spare parts

790.020.04	990.078.00	991.061.00	791.003.00
790.030.04	990.078.00	991.061.00	791.003.00

Spare parts: 990.423.00 Shield for 12.7mm bearing  
990.058.00 1/8"x3/8"x1/2" TCEI screw  
991.057.00 3/32" hex key

# Classical Bead Bits

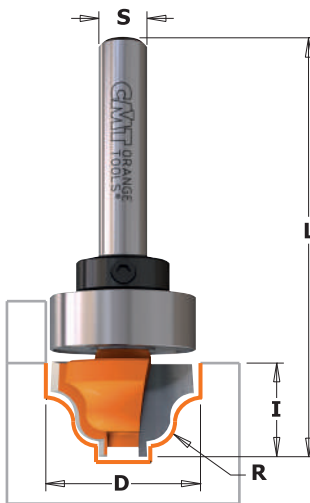

## 865B

This bit equipped with a bearing fixed on the shank gives you even more decorative possibilities such as inlays and groove work on furniture panels, vitrines, and drawer fronts. A wide flat bottom cut and positioning just above the wood surface, lets you see the results immediately.

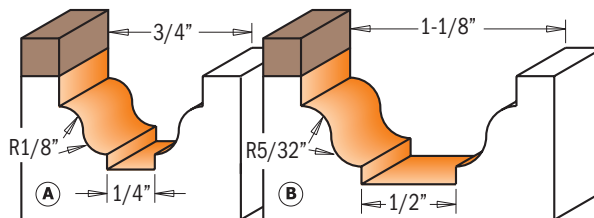

Drawing is 1:1 scale

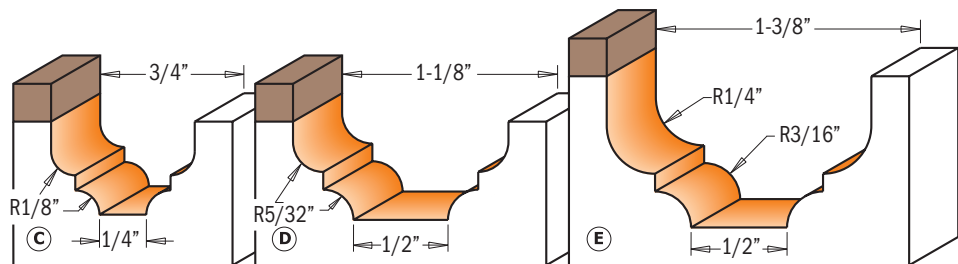

ORDER NO.	ORDER NO.	Box	D	R	I	L	PROFILE	
<b>S=Ø1/4" shank</b>	<b>S=Ø1/2" shank</b>		inches	mm	inches	inches		
865.201.11B	865.702.11B	10	3/4	19.05	1/8	31/64	2-1/8	A
	865.802.11B	10	1-1/8	28.6	5/32	9/16	2-5/16	B
865.301.11B	865.802.11B	10	3/4	19.05	1/8	31/64	2-1/8	C
	865.803.11B	10	1-1/8	28.6	5/32	17/32	2-9/32	D
	865.803.11B	10	1-3/8	34.9	1/4	23/32	2-39/64	E

### Spare parts

791.004.00	541.001.00	991.056.00
791.027.00	541.002.00	991.056.00
791.004.00	541.001.00	991.056.00
791.027.00	541.002.00	991.056.00
791.029.00	541.002.00	991.056.00

Spare parts: 990.005.00 M3x3mm TSEI screw

# Decorative Beading Bits

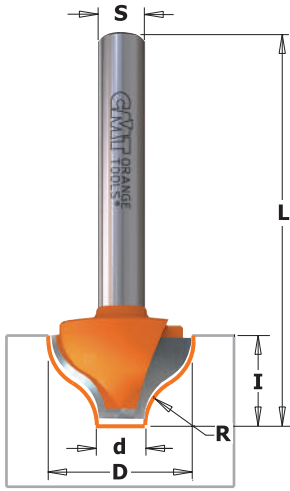

## 865

This new CMT bit produces a classic single or double-edged bead. Ideal for creating a marked decorative effect on panel, door and drawer work.

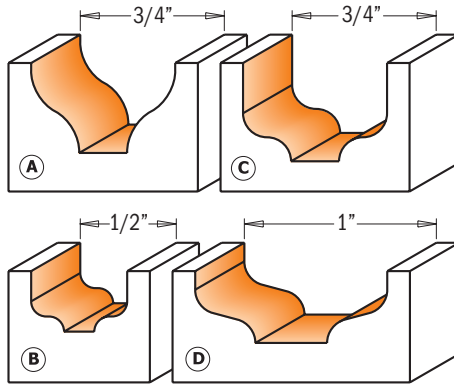

Drawing is 1:1 scale

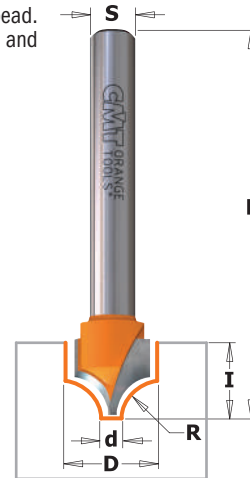

**865.402.11**

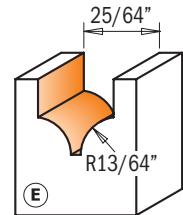

Drawing is 1:1 scale

ORDER NO. S=01/4" shank	ORDER NO. S=01/2" shank		D	d	R	I	L	PROFILE	
			inches	mm	inches	inches	inches		
<b>865.402.11</b>		10	25/64	10	1/16	13/64	25/64	1-31/32	E
<b>865.002.11</b>		10	1/2	12.7	5/32	5/64	5/16	2	B
<b>865.001.11</b>	<b>865.501.11</b>	10	3/4	19.05	1/4	1/4	7/16	2	A
	<b>865.503.11</b>	10	3/4	19.05	1/4	1/8	33/64	2-43/64	C
	<b>865.504.11</b>	10	1	25.4	3/8	1/8	3/8	1-59/64	D

# Decorative Ogee Bits

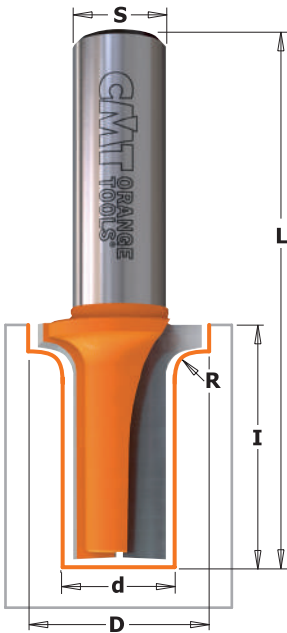

**865.905.11**



**865.903.11**  
**865.904.11**

## 865.9

Enhance your doors and drawer fronts and leave your visitors amazed! The cutting edges on these ogee bits are carbide-tipped for effective, smooth and eye-catching work.

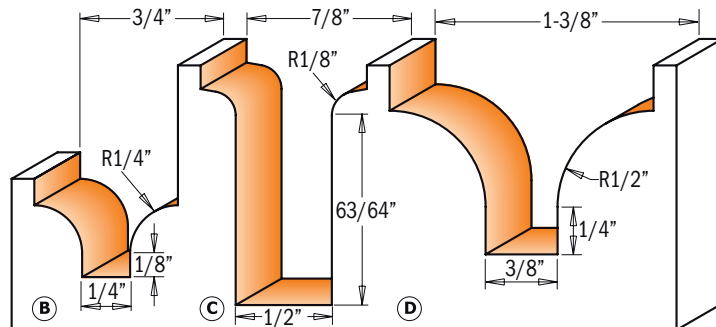

Drawing is 1:1 scale

ORDER NO. S=01/2" shank		D	d	R	I	L	PROFILE	
		inches	mm	inches	inches	inches		
<b>865.903.11</b>	10	3/4	19.05	1/4	1/4	33/64	2	B
<b>865.905.11</b>	10	7/8	22.2	1/2	1/8	1-1/4	2-3/4	C
<b>865.904.11</b>	10	1-3/8	34.9	3/8	1/2	63/64	2-37/64	D



# Plunge Ogee Bits

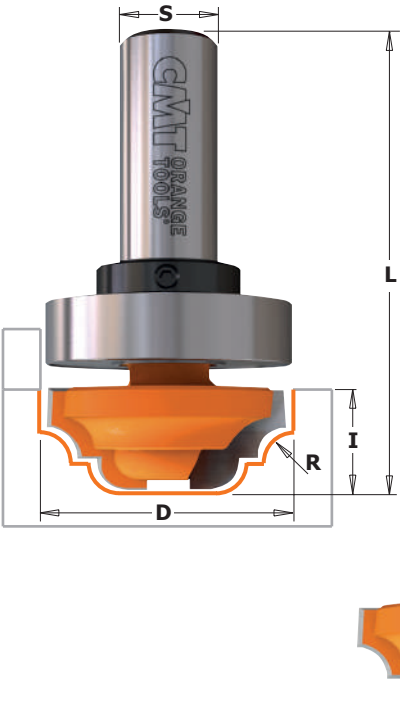

## 848 - 848B



You will never run out of ideas with this creative bit. Add a classic touch to any edge or highlight door fronts and panels with decorative layered effects.

**SHOP TIPS:** for even more options, try the CMT plunge ogee with bearing for precision profiling. The bearing guarantees excellent decorative edgework.

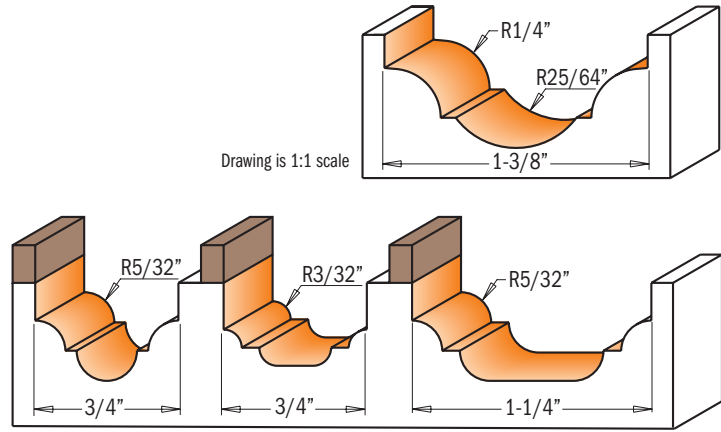

ORDER NO. S=Ø1/4" shank	ORDER NO. S=Ø1/2" shank		D		R	I	L
			inches	mm	inches	inches	inches
848.190.11		10	3/4	19.05	5/32	1/2	2-1/64
848.191.11		10	3/4	19.05	3/32	7/16	2-3/32
	848.817.11	10	1-1/4	31.7	5/32	1/2	2-9/32
	848.850.11	10	1-3/8	34.9	1/4 - 25/64	45/64	2-43/64
WITH TOP BEARING GUIDE							
848.190.11B		10	3/4	19.05	5/32	1/2	2-1/64
848.191.11B		10	3/4	19.05	3/32	7/16	2-3/32
	848.817.11B	10	1-1/4	31.7	5/32	1/2	2-9/32

Spare parts		
791.004.00	541.001.00	991.056.00
791.004.00	541.001.00	991.056.00
791.015.00	541.002.00	991.056.00

Spare parts: 990.005.00 M3x3mm TSEI screw

# Decorative Ogee Bits

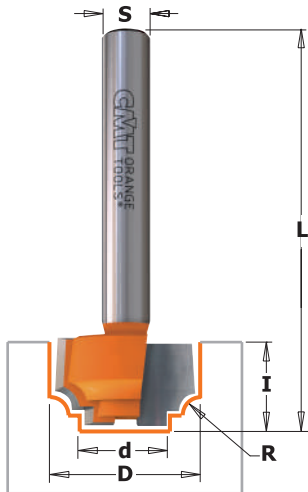

## 865.1



This new CMT bit produces a classic single or double edged bead. Ideal for creating a marked decorative effect on panel, door and drawer work.

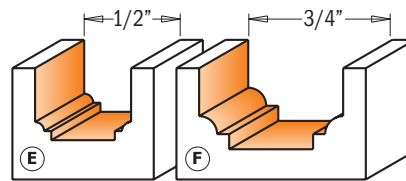

ORDER NO. S=Ø1/4" shank		D		d	R	I	L	PROFILE
		inches	mm	inches	inches	inches	inches	
865.101.11	10	1/2	12.7	21/64	3/64	1/2	2	E
865.102.11	10	3/4	19.05	7/16	3/32	7/16	2	F

# Roman Ogee Bits

**840**



The roman ogee may be the most popular edge treatment in woodworking, and it is certainly one of the most beautiful and varied in classic design.

**SHOP TIPS:** given the complexity of this kind of machining, for best results, multiple passes are recommended.

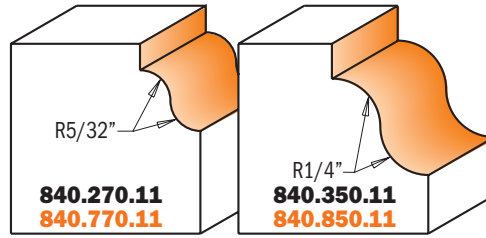

Drawing is 1:1 scale

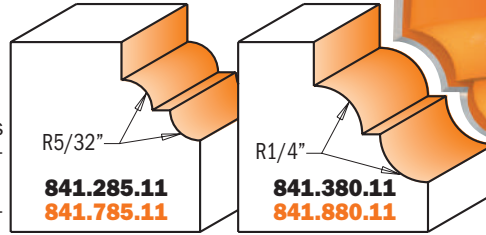

**841**

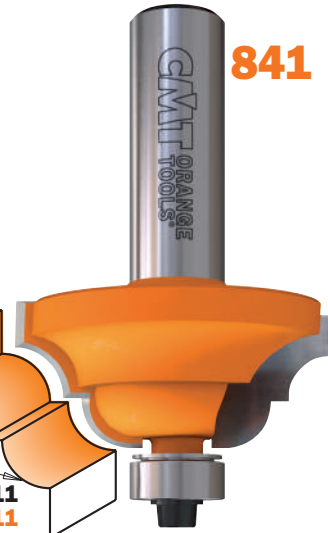

An extra horizontal cutting edge provides refined style and elegance to these traditional profiles **840**.

**SHOP TIPS:** for best results, multiple passes are recommended.

ORDER NO. S=01/4" shank	ORDER NO. S=01/2" shank		R		D	I	Spare parts			
			inches	mm	inches	inches				
<b>840.270.11</b>	<b>840.770.11</b>	10	5/32	4	1-1/8	29/64	990.423.00	791.003.00	990.058.00	991.057.00
<b>840.350.11</b>	<b>840.850.11</b>	10	1/4	6.35	1-1/2	11/16	990.423.00	791.003.00	990.058.00	991.057.00
<b>841.285.11</b>	<b>841.785.11</b>	10	5/32	4	1-5/16	1/2	990.423.00	791.003.00	990.058.00	991.057.00
<b>841.380.11</b>	<b>841.880.11</b>	10	1/4	6.35	1-11/16	3/4	990.423.00	791.003.00	990.058.00	991.057.00

**SHOP TIPS:** after resharpening, replace bearing 791.003.11 (Ø12.7mm) with undersized bearing **791.063.00** (Ø12.5mm)

# Classical Ogee Bits

**844**



CMT's classical ogee bits feature an inverted ogee profile, with the concave edge adjacent to the upper surface of the workpiece. A vertical bead was added to separate the curves and creates an attractive detail.

**SHOP TIPS:** this type of machining can be very challenging, for best results, multiple passes are recommended.

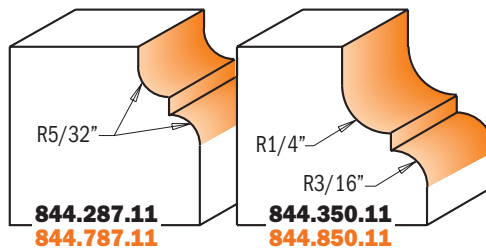

Drawing is 1:1 scale

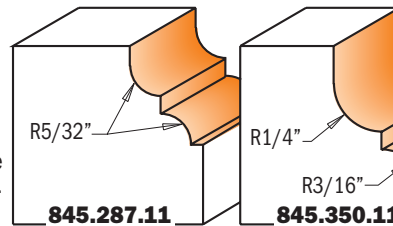

**845**

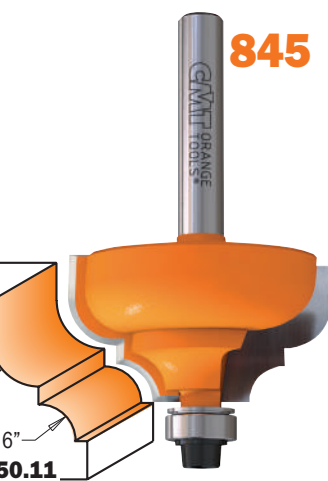

This profile includes a horizontal bead along the bottom of the profile adding a decorative detail to the traditional ogee design.

**SHOP TIPS:** for best results, multiple passes are recommended.

ORDER NO. S=01/4" shank	ORDER NO. S=01/2" shank		R		D	I	Spare parts			
			inches	mm	inches	inches				
<b>844.287.11</b>	<b>844.787.11</b>	10	5/32	4	1-1/8	1/2	990.423.00	791.003.00	990.058.00	991.057.00
<b>844.350.11</b>	<b>844.850.11</b>	10	1/4 - 3/16	6.35 - 4.8	1-3/8	47/64	990.423.00	791.003.00	990.058.00	991.057.00
<b>845.287.11</b>	<b>845.787.11</b>	10	5/32	4	1-1/8	1/2	990.422.00	791.002.00	990.058.00	991.057.00
<b>845.350.11</b>	<b>845.850.11</b>	10	1/4 - 3/16	6.35 - 4.8	1-3/8	47/64	990.422.00	791.002.00	990.058.00	991.057.00

## Ogee with Fillet Bits

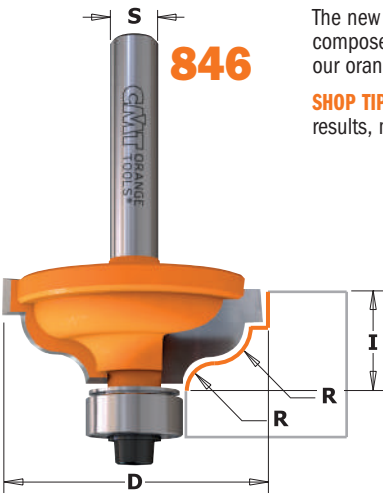

**846**

The new decorative possibilities with this bit are endless. Every bit is composed of the highest quality tungsten carbide and protected with our orange trademarked P.T.F.E. coating.

**SHOP TIPS:** this type of machining can be very challenging, for best results, multiple passes are recommended.

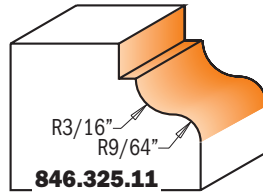

**846.325.11**  
**846.825.11**

Drawing is 1:1 scale

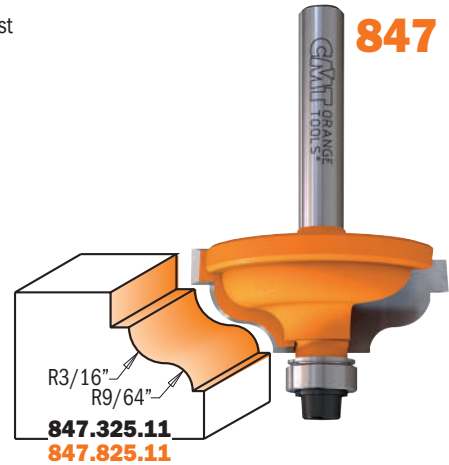

**847**

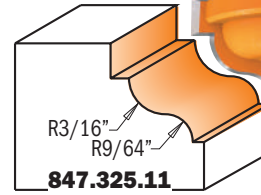

**847.325.11**  
**847.825.11**

ORDER NO. S=Ø1/4" shank	ORDER NO. S=Ø1/2" shank		R		D	I
			inches	mm	inches	inches
<b>846.325.11</b>	<b>846.825.11</b>	10	3/16 - 9/64	4.8 - 3.6	1-3/8	1/2
<b>847.325.11</b>	<b>847.825.11</b>	10	3/16 - 9/64	4.8 - 3.6	1-3/8	1/2

**Spare parts**

990.423.00	791.003.00	990.058.00	991.057.00
990.423.00	791.003.00	990.058.00	991.057.00

**SHOP TIPS:** after resharpening, replace bearing as follow:  
791.002.00 (Ø9.5mm) with undersized bearing **791.062.00** (Ø9.3mm)  
791.003.00 (Ø12.7mm) with undersized bearing **791.063.00** (Ø12.5mm)

## Ogee Bits



**859**

These profiles are the mirror image of the traditional roman ogee. They add sharp defining details to the edges of cabinets and furniture, before rolling into a smooth convex shape.

**SHOP TIPS:** this type of machining can be very challenging, for best results, multiple passes are recommended.

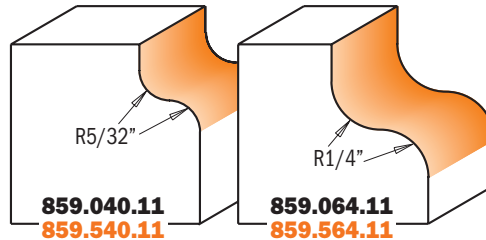

**859.040.11**  
**859.540.11**

**859.064.11**  
**859.564.11**

Drawing is 1:1 scale

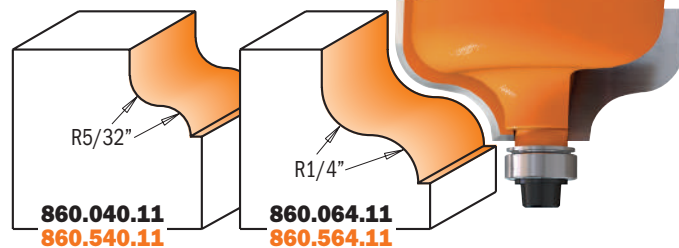

**860**

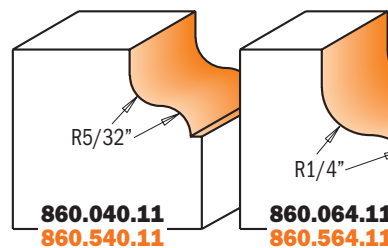

**860.040.11**  
**860.540.11**

**860.064.11**  
**860.564.11**

ORDER NO. S=Ø1/4" shank	ORDER NO. S=Ø1/2" shank		R		D	I
			inches	mm	inches	inches
<b>859.040.11</b>	<b>859.540.11</b>	10	5/32	4	1-1/8	1/2
<b>859.064.11</b>	<b>859.564.11</b>	10	1/4	6.35	1-1/2	45/64
<b>860.040.11</b>	<b>860.540.11</b>	10	5/32	4	1-1/8	1/2
<b>860.064.11</b>	<b>860.564.11</b>	10	1/4	6.35	1-1/2	45/64

**Spare parts**

990.423.00	791.003.00	990.058.00	991.057.00
990.423.00	791.003.00	990.058.00	991.057.00
990.422.00	791.002.00	990.058.00	991.057.00
990.422.00	791.002.00	990.058.00	991.057.00

**SHOP TIPS:** after resharpening, replace bearing as follow:  
791.002.00 (Ø9.5mm) with undersized bearing **791.062.00** (Ø9.3mm)  
791.003.00 (Ø12.7mm) with undersized bearing **791.063.00** (Ø12.5mm)

# Adjustable Roundover & Bevel Router Bits



## 800.623



These CMT bits are ideal for making attractive edgework! Create a double 3/16" (4.76mm) roundover profile, a double 45° bevel or even a mixed profile on your wood panels easily and in a cost-effective way! Interchangeable shims are included to allow for different stock thicknesses according to the board. To be used on table-mounted routers. Do not use these bits with hand-held power tools.

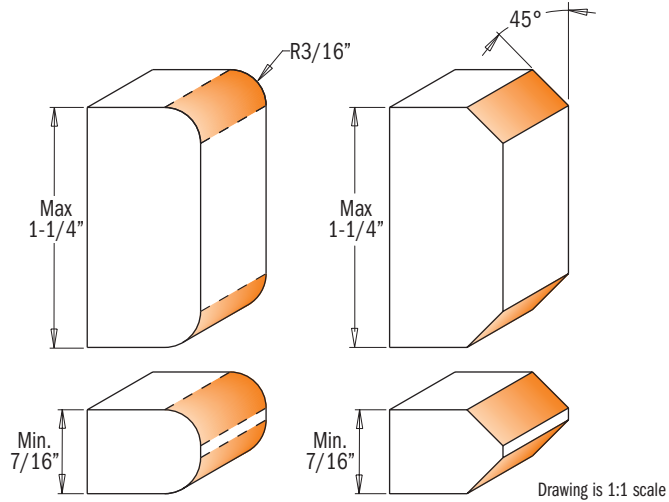

ORDER NO.		D		T <sub>1</sub>	R	A	L
S=01/2" shank		inches	mm	inches	inches		inches
800.623.11	10	1-1/2	38.1	7/16 - 1-1/4	3/16	45°	3-15/16

### Spare parts

		45° R3/16"		R 3/16" 45°
824.137.00	791.037.00	822.029.11		822.030.11

Spare parts: 541.500.00 3mm spacer  
541.515.00 0.1mm spacer

541.517.00 0.5mm spacer  
541.518.00 1mm spacer

541.519.00 5.8mm spacer  
990.020.00 Nut for arbor, M8 thread

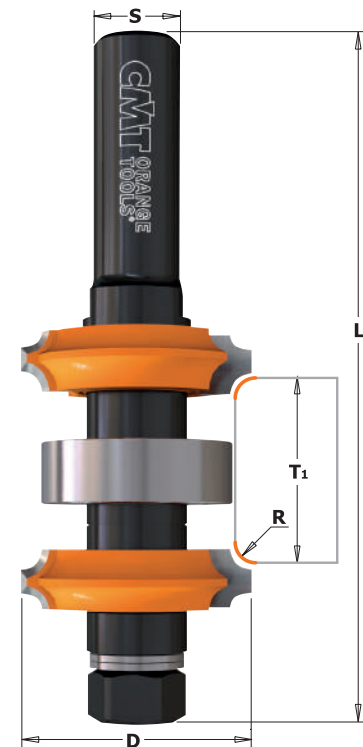

# Adjustable Double Roundover Router Bits

## 800.622



Create awesome furnishing decorations with these new CMT bits! They provide a double 5/64" (2mm) and 1/8" (3mm) roundover profile on your wood panels easily and in a cost-effective way! To be used on table-mounted routers. Do not use these bits with hand-held power tools. Router tables only.

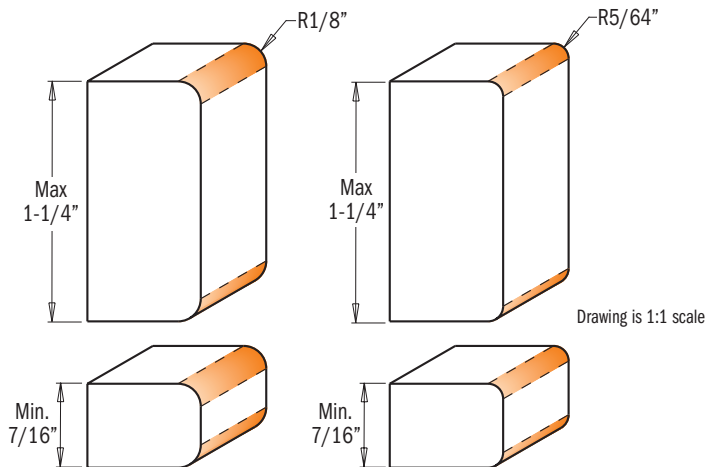

ORDER NO.		D		T <sub>1</sub>	R	R	L
S=01/2" shank		inches	mm	inches	inches	inches	inches
800.622.11	10	1-11/32	34	7/16 - 1-1/4	1/8	5/64	3-15/16

### Spare parts

		R5/64" R1/8"		R1/8" R5/64"
824.137.00	791.037.00	822.031.11		822.032.11

Spare parts: 541.500.00 3mm spacer  
541.515.00 0.1mm spacer

541.517.00 0.5mm spacer  
541.518.00 1mm spacer

541.519.00 5.8mm spacer  
990.020.00 Nut for arbor, M8 thread



# Wainscot/Paneling Bits

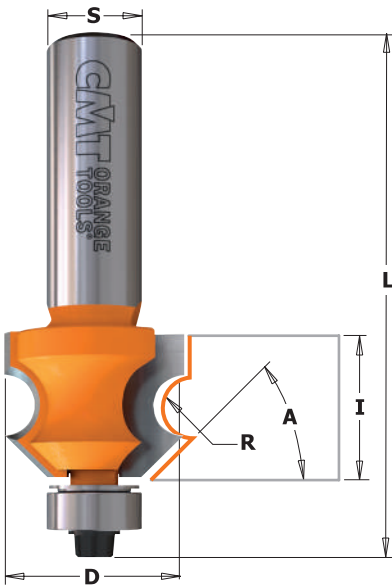

## 861.6

This new router bit designed for 3/4" (19mm) thick stock is perfect for creating wainscots and panels on your walls. Simply create a 1/4" (6.35mm) tongue-and-groove interlock with a CMT 800.626.11, then, with two passes mill an attractive traditional beadboard profile with this new bit. Perfect for cabinets, bookcase backings, ceiling and wall paneling.

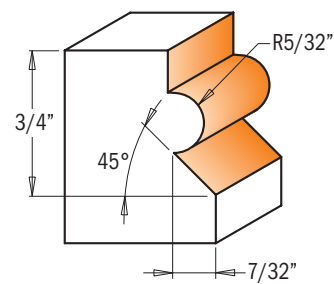
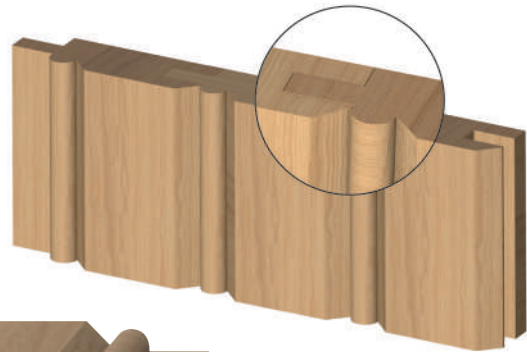

Drawing is 1:1 scale

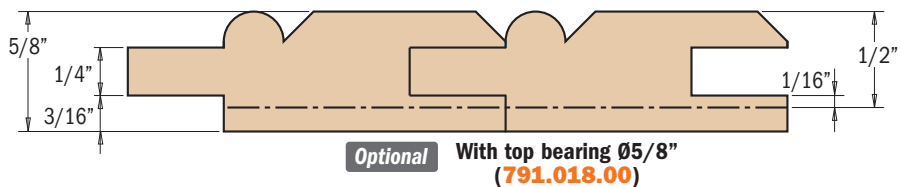
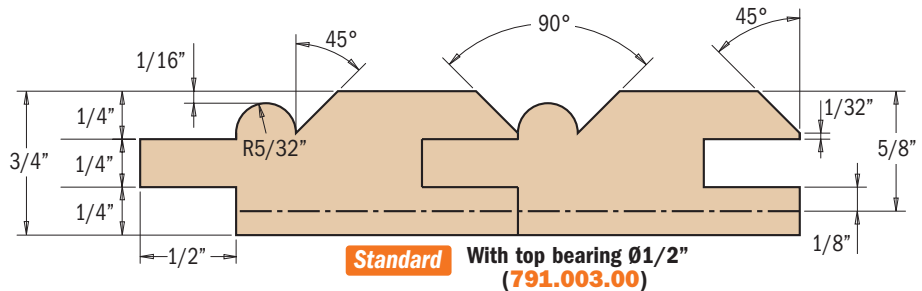

ORDER NO.		D		I	R	A	L
S=Ø1/2" shank		inches	mm	inches	inches		inches
861.601.11	10	15/16	23.8	3/4	5/32	45°	2-43/64

Spare parts

990.423.00	791.003.00	990.058.00	991.057.00

**SHOP TIPS:** after resharpening, replace bearing 791.003.11 (Ø12.7mm) with undersized bearing 791.063.00 (Ø12.5mm)

# Bead & Bull Nose Bits

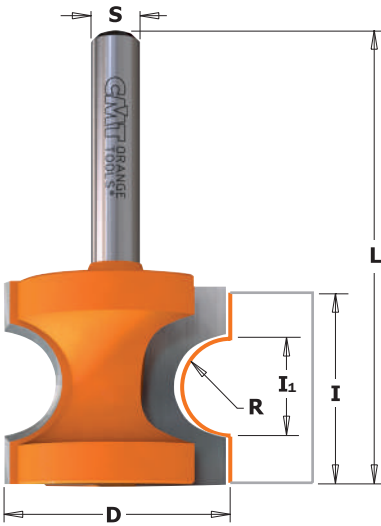

## 854



CMT's bull nose bits create elegantly finished edges on stair treads, window sills and shelves in one pass. Add a final touch by using a cutter with a bead diameter wider than the stock thickness.

**SAFETY TIPS:** to be used only on router tables equipped with a fence except in the case Do not remove the workpiece while the bit is routing.

ORDER NO. S=01/4" shank	ORDER NO. S=01/2" shank		R	D	I <sub>1</sub>	I	L
			inches	mm	inches	inches	inches
854.002.11	854.502.11	10	1/8	3.2	7/8	1/4	2
854.003.11	854.503.11	10	3/16	4.75	1	3/8	2-1/8
854.004.11	854.504.11	10	1/4	6.35	1-1/8	1/2	2-1/4
	854.507.11	10	3/8	9.52	1-3/8	3/4	2-7/8
	854.509.11	10	1/2	12.7	1-3/4	1-1/16	3-1/8

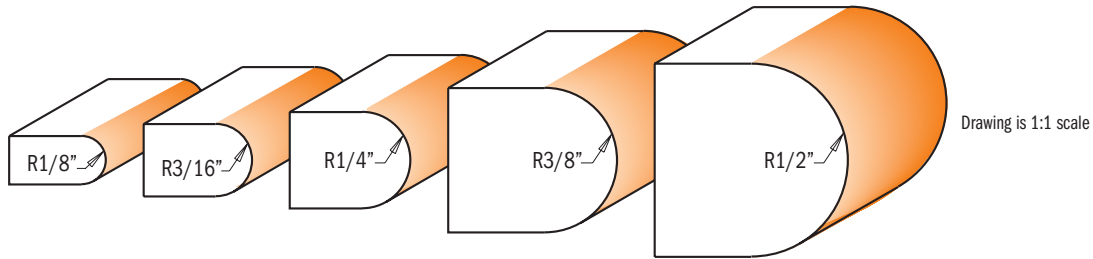

# Corner Beading Bits

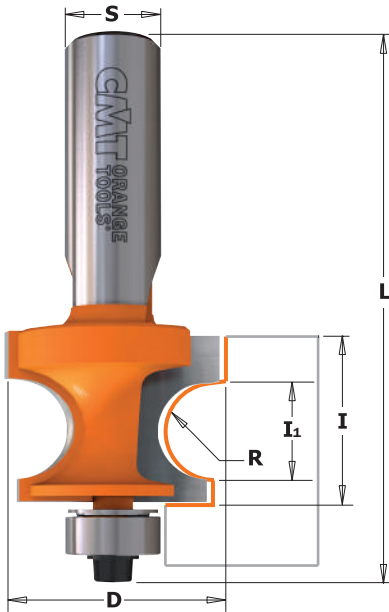

## 861



Make beautiful traditional beads and edge beads or turn old beads into new moldings with the new CMT corner beading bits with bearing. Featuring carbide-tipped cutting edges and orange P.T.F.E. non-stick coating, these bits provide excellent results on corner beads. Run the bead twice to form a complete corner bead.

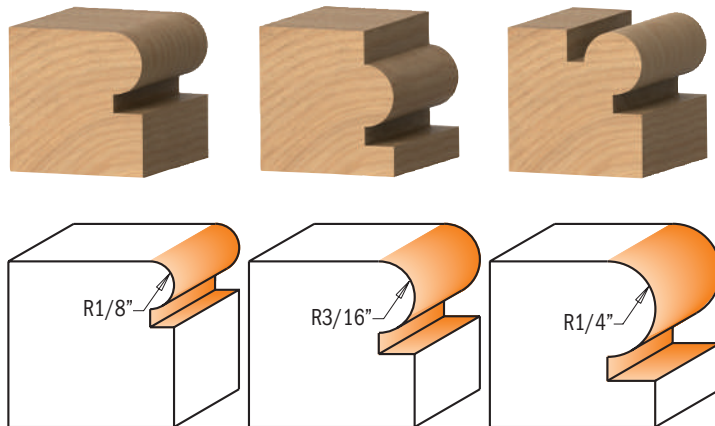

ORDER NO. S=01/4" shank	ORDER NO. S=01/2" shank		R	D	I <sub>1</sub>	I	L
			inches	mm	inches	inches	inches
861.032.11	861.532.11	10	1/8	3.2	7/8	1/4	2-1/4
861.048.11	861.548.11	10	3/16	4.75	1	3/8	2-25/64
861.064.11	861.564.11	10	1/4	6.35	1-1/8	1/2	2-41/64
			1/4	6.35	1-1/8	1/2	2-9/16
			1/4	6.35	1-1/8	1/2	2-25/32

Spare parts		
990.423.00	791.003.00	990.058.00
990.423.00	791.003.00	990.058.00
990.423.00	791.003.00	990.058.00
990.423.00	791.003.00	990.058.00
990.423.00	791.003.00	990.058.00
990.423.00	791.003.00	990.058.00

Spare parts: 991.057.00 3/32" hex key

# Edge-Fluting Bits

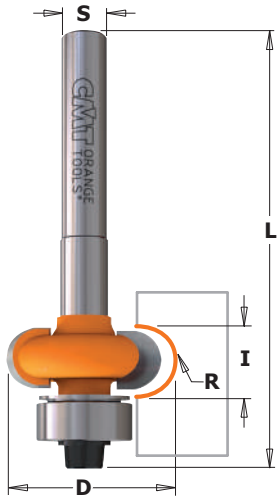

## 862

The edge-fluting bearing guided bits are quick to set up and can be used for curved screens, small radius grooves, doors etc. No side fence is required. Use in a handheld or table-mounted router.



For top bearing version: use bearing **791.010.00** and stop collar **541.001.00** (optional)

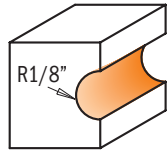

Drawing is 1:1 scale

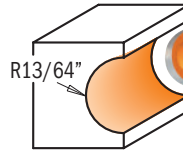
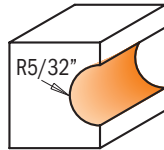

ORDER NO.		R	D	I	L
S=01/4" shank		inches	mm	inches	inches
862.032.11	10	1/8	3.2	3/4	2-1/4
862.040.11	10	5/32	4	13/16	2-1/4
862.050.11	10	13/64	5	57/64	2-1/4

### Spare parts

990.423.00	791.003.00	990.058.00	991.057.00
990.423.00	791.003.00	990.058.00	991.057.00
990.423.00	791.003.00	990.058.00	991.057.00

# CMT Moulding System

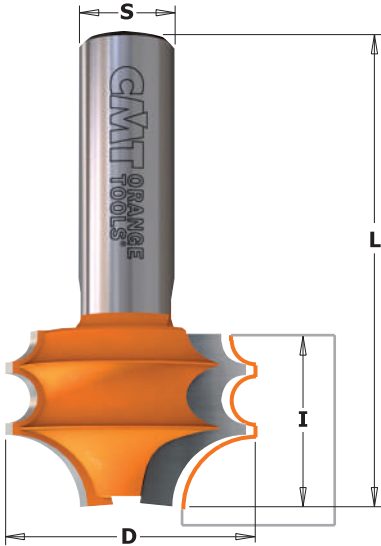

## 856.852

If the standard selection of moulding and mill work you find in today's lumber shops isn't satisfactory to your woodworking tastes, then look to CMT's moulding system instead. With these bits, you can make dozens of elaborate profiles by combining two or more passes. Avoid the average and create your own mouldings. Some initial suggestions are illustrated below.

**SAFETY TIPS:** use these bits with a fence. The profiles shown below are milled from heavy stock then refined to the desired shape.



## 856.851

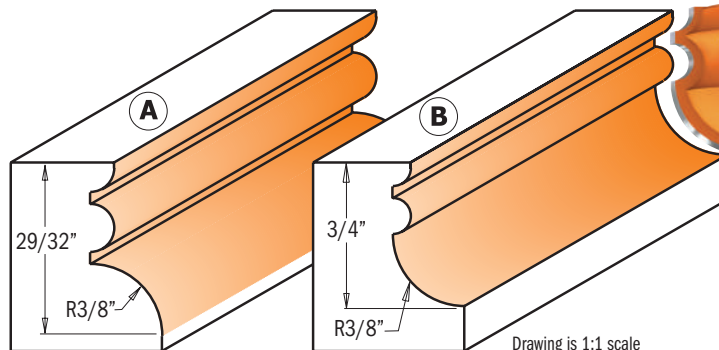

Drawing is 1:1 scale

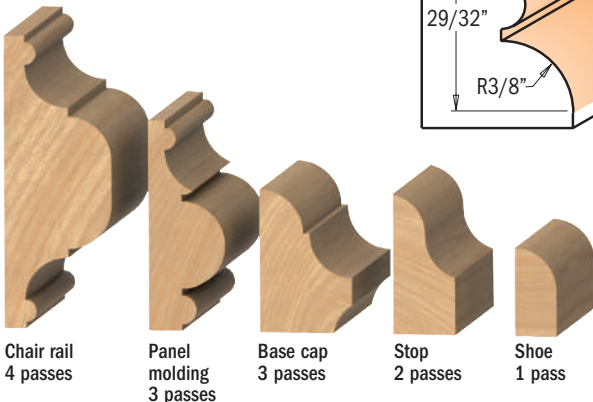

ORDER NO.		D	I	L	PROFILE	
S=01/2" shank		inches	mm	inches		
856.852.11	10	1-1/4	31.7	29/32	2-13/32	A
856.851.11	10	1-1/4	31.7	3/4	2-1/4	B

# Moulding Bits



For best results use these bits with 1800W routers. It is possible to use 1100W routers but only for brief passes that are short in depth.

**SHOP TIPS:** multiple pass operations require advance planning. To avoid making a mistake that could render it impossible to finish the job, carefully consider the entire cutting sequence before you begin.

**SAFETY TIPS:** all large diameter bits such as these should be used with caution and on router tables equipped with a fence. When possible, reduce the RPM.

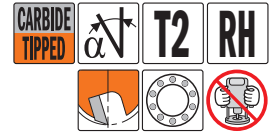

**867.701**

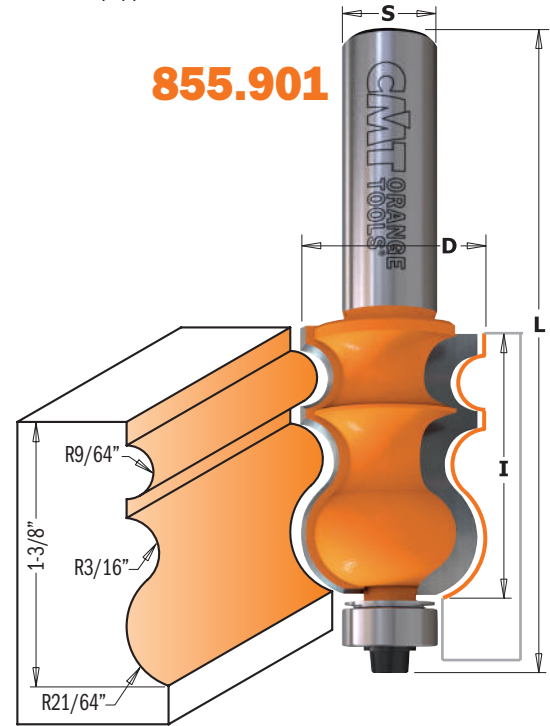

**855.901**

Drawing is 1:1 scale

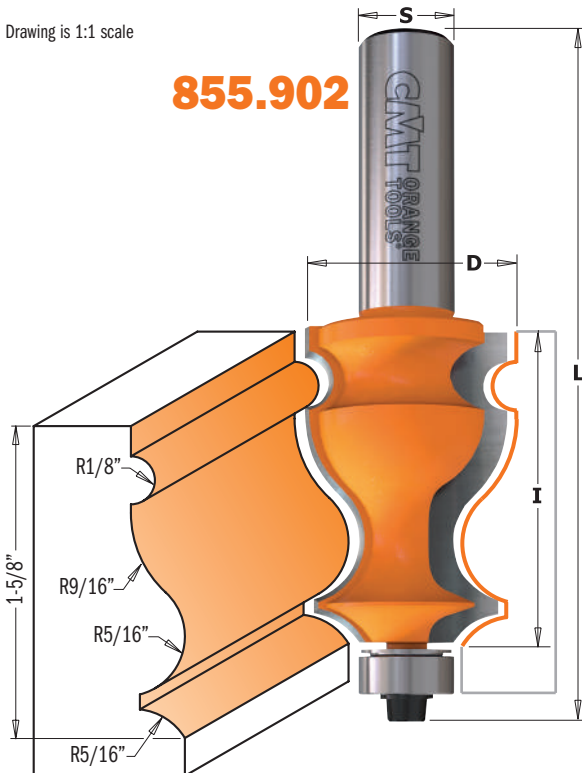

**855.902**

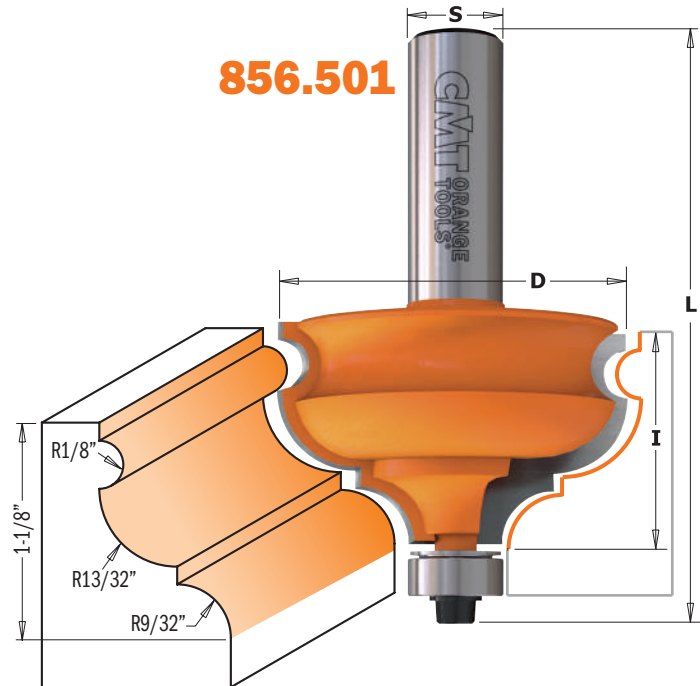

**856.501**

ORDER NO.		D	I	L
S=Ø1/2" shank		inches	mm	inches
855.901.11	10	15/16	23.8	1-3/8
855.902.11	10	1-1/16	27	1-5/8
856.501.11	10	1-7/8	47.6	1-1/8
867.701.11	10	2-1/4	58	1

**Spare parts**

990.423.00	791.003.00	990.058.00	991.057.00
990.423.00	791.003.00	990.058.00	991.057.00
990.423.00	791.003.00	990.058.00	991.057.00

**SHOP TIPS:** after resharpening, replace bearing 791.003.11 (Ø12.7mm) with undersized bearing 791.063.00 (Ø12.5mm)



# Moulding Bits

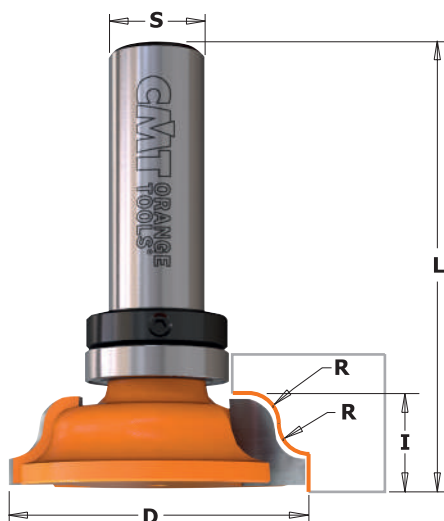

## 867.5B - 867.6B



CMT's new moulding bits allow you to shape elegant moldings with your table saw and router. Unlike any commercially available crown moldings, moldings made with these bits are easy to install and create a finished appearance. After shaping the cove, you can use special router bits with inverted profiles to create different edges and complete the moulding.

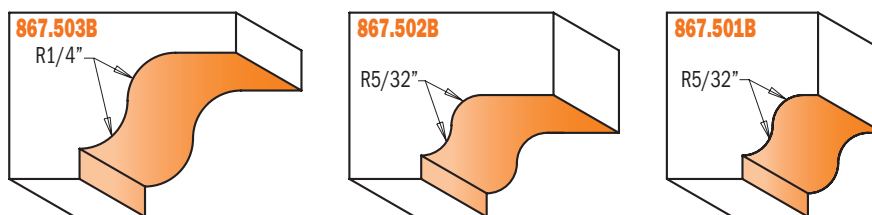
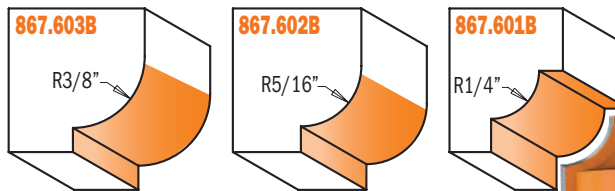

Drawing is 1:1 scale

ORDER NO.	S=01/2" shank	R		D	I	L
		inches	mm			
867.501.11B	10	5/32	4	1-9/16	29/64	2-1/4
867.502.11B	10	5/32	4	2-1/8	29/64	2-19/32
867.503.11B	5	1/4	6.35	2-3/8	11/16	2-53/64
867.601.11B	10	1/4	6.35	1-1/2	31/64	2-1/4
867.602.11B	10	5/16	7.94	1-3/8	33/64	2-9/32
867.603.11B	10	3/8	9.52	1-1/2	37/64	2-21/64

### Spare parts

791.011.00	541.002.00	990.005.00	991.056.00
791.011.00	541.002.00	990.005.00	991.056.00
791.011.00	541.002.00	990.005.00	991.056.00
791.011.00	541.002.00	990.005.00	991.056.00
791.011.00	541.002.00	990.005.00	991.056.00
791.011.00	541.002.00	990.005.00	991.056.00

# Door Lip Bit & Finger Grip Bit

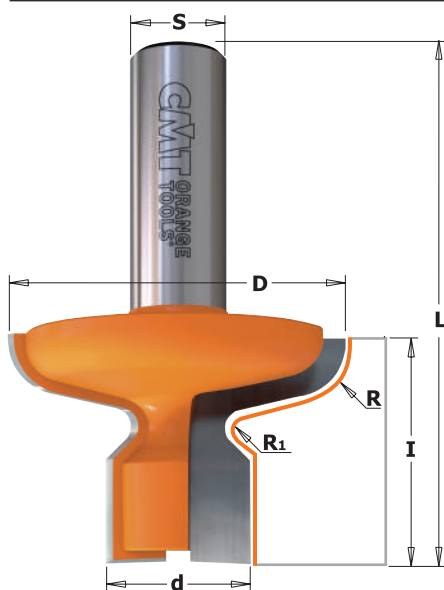

## 855.604-606



Why interrupt the subtle linearity of an all-wood drawer front or cabinet door with a metal knob or handle? Two options are available: a template profile made directly in the wood or a European-style hardwood pull as illustrated below.

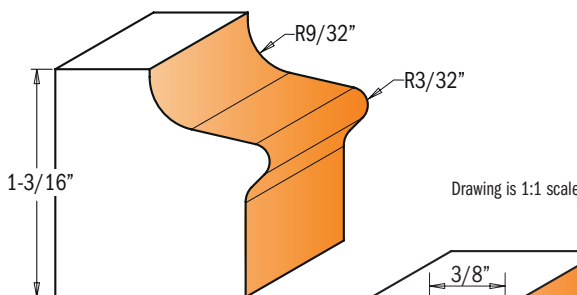

855.604.11

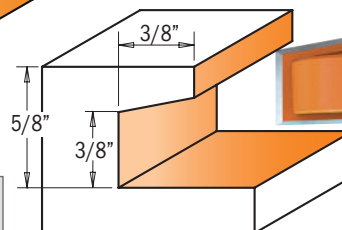

855.606.11

ORDER NO.	S=01/2" shank	D		d	I	R	R <sub>1</sub>	L
		inches	mm					
855.606.11	10	1-27/64	36	5/8	5/8	9/32	3/32	2-3/8
855.604.11	10	1-7/8	47.6	7/8	1-3/16	9/32	3/32	2-5/8

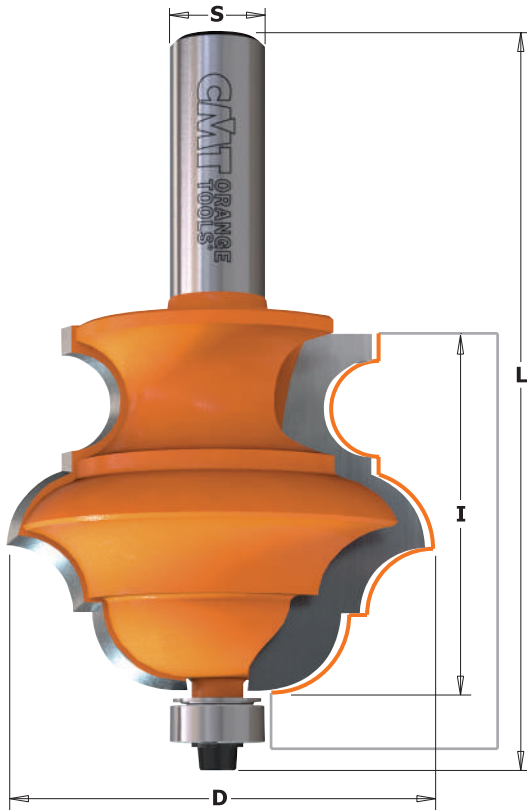

## 856.8



Create endless profiles with CMT multiprofile bits. Simply adjust the height of the bit to create classic profiles in one single pass, or make more complex decorative effects in multiple passes. The bits super-strength steel body can withstand long-lasting cutting operations, and the micrograin carbide tips remain sharp longer for superior performance. In addition these bits feature non-stick P.T.F.E. coating and anti-kickback design. To be used on tables equipped with a fence.

**SAFETY TIPS:** to make small mouldings as shown below, cut the profile from large stock, removing excess material as you work as this will facilitate easier control. Keep hands far from the bit when working.

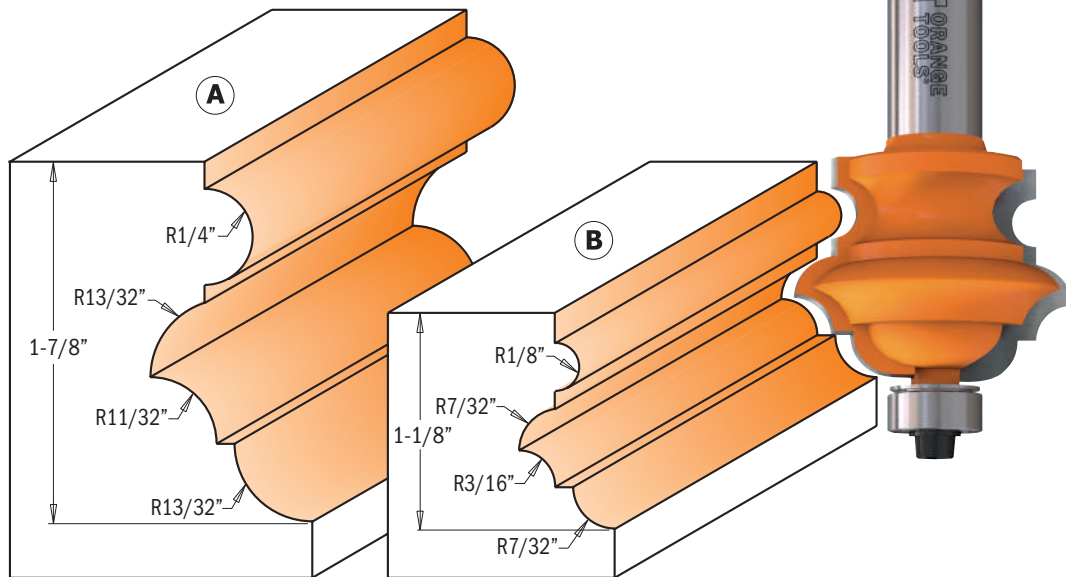
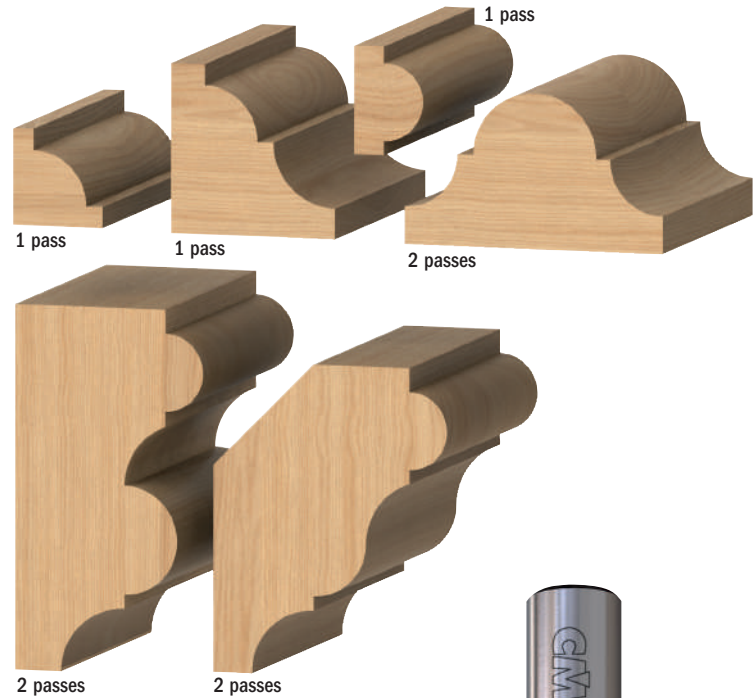

Drawing is 1:1 scale

ORDER NO.	S=01/2" shank	D		I	L	PROFILE
		inches	mm	inches	inches	
856.802.11	5	2-3/16	55.6	1-7/8	3-25/32	A
856.801.11	10	1-1/2	38.1	1-1/8	3-1/16	B

Spare parts

990.423.00	791.003.00	990.058.00	991.057.00
990.423.00	791.003.00	990.058.00	991.057.00

# Finger Pull Bit

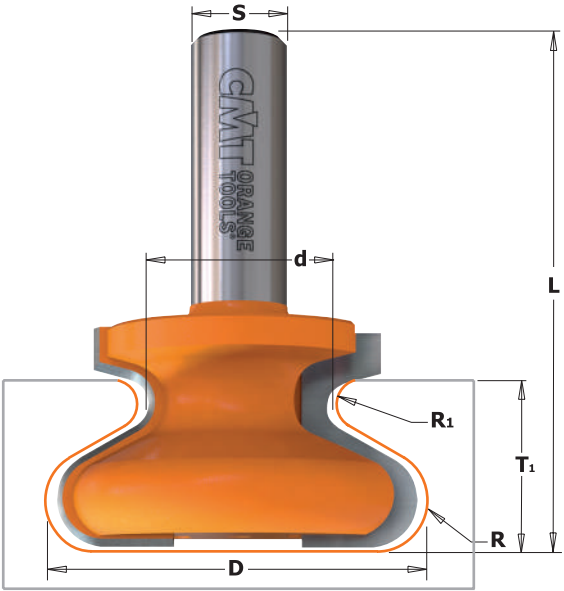

## 855



Why interrupt the subtle linearity of an all-wood drawer front or cabinet door with a metal knob or handle? Use a CMT finger pull bit and make a harmonious wooden handle. Two options are available: a template profile made directly in the wood or a European-style hardwood pull as illustrated below.

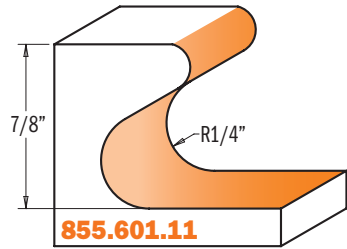
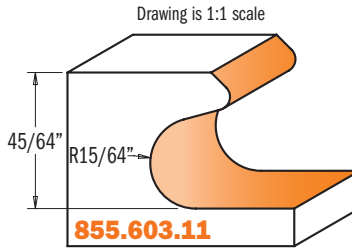
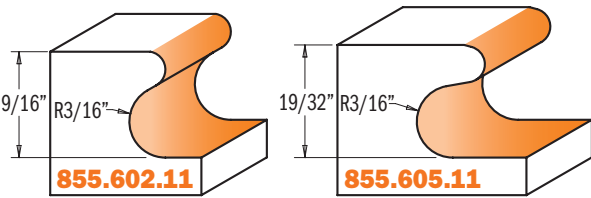
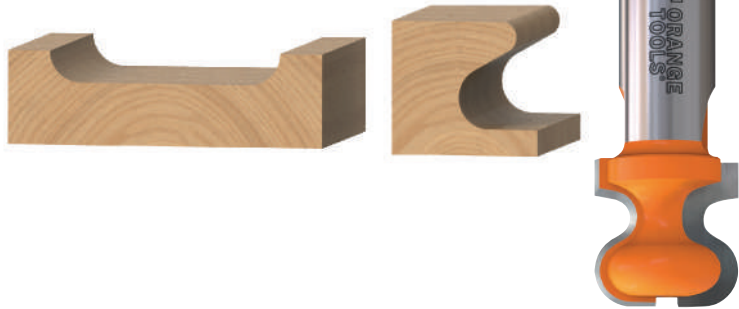

ORDER NO. S=Ø1/2" shank		D		d	T <sub>1</sub>	I	R	R <sub>1</sub>	L
		inches	mm	inches	inches	inches	inches	inches	inches
855.602.11	10	3/4	19.05	3/8	9/16	3/4	3/16	3/32	2-1/4
855.605.11	10	1-9/64	29	7/16	19/32	3/4	3/16	3/32	2-3/8
855.603.11	10	1-1/2	38.1	43/64	45/64	13/16	15/64	5/64	2-7/16
855.601.11	10	1-7/8	47.6	15/16	7/8	1-1/8	1/4	1/8	2-5/8

# Window Sill & Finger Bits

## 855.8 - 855.8B



Originally, these profiles were designed for shaping the edges of window sills. Yet, these bits also can be used to create finger pulls on the edges of doors and drawers. These bits are available with top bearings for curved template work or without bearings for straight cuts against a fence. Recommended for router table use only.

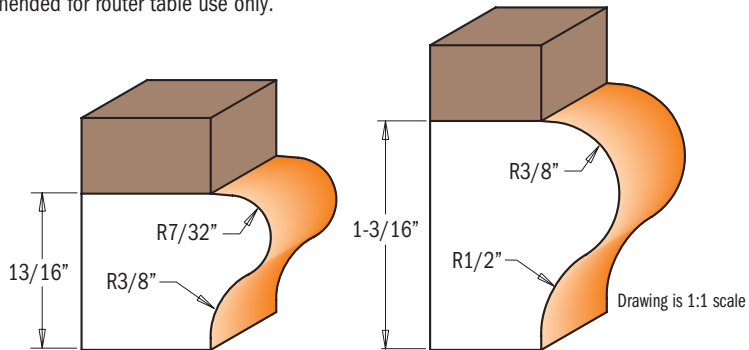
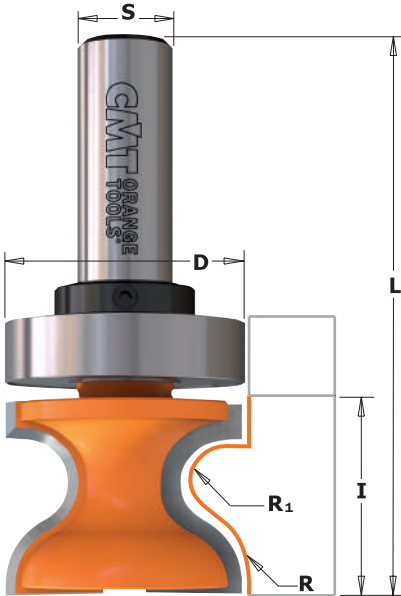

ORDER NO. S=Ø1/2" shank		R	R <sub>1</sub>	D	I	L
		inches	inches	inches	inches	inches
855.804.11	10	3/8	7/32	1-1/4	1	2-7/8
855.805.11	10	1/2	3/8	1-1/2	1-3/8	3-3/8
WITH TOP BEARING						
855.804.11B	10	3/8	7/32	1-1/4	1	2-7/8
855.805.11B	10	1/2	3/8	1-1/2	1-3/8	3-3/8

Spare parts			
791.015.00	541.002.00	990.005.00	991.056.00
791.020.00	541.002.00	990.005.00	991.056.00

# Table Edge & Hand Rail Bits

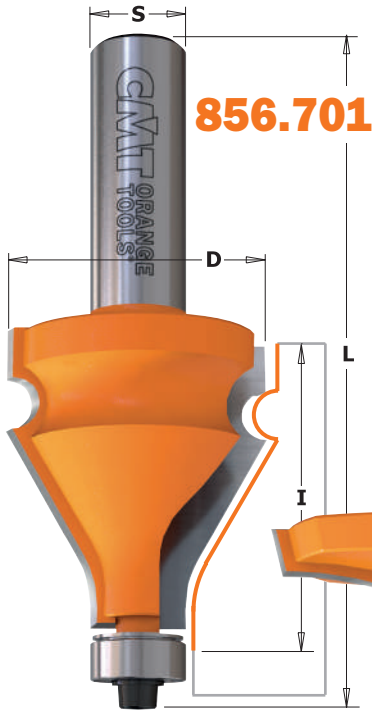

**856.701**



The **856.601.11** guarantees well-proportioned smooth curves. Complete the job with the **856.701.11** bit featuring a 30° bevel edge and a 3.2mm bead for beautifully functional hand rails.

**SAFETY TIPS:** these profile bits remove large amounts of stock and produce consistent quantities of dust. We recommend using a vacuum to keep the work area safe.



**856.601**

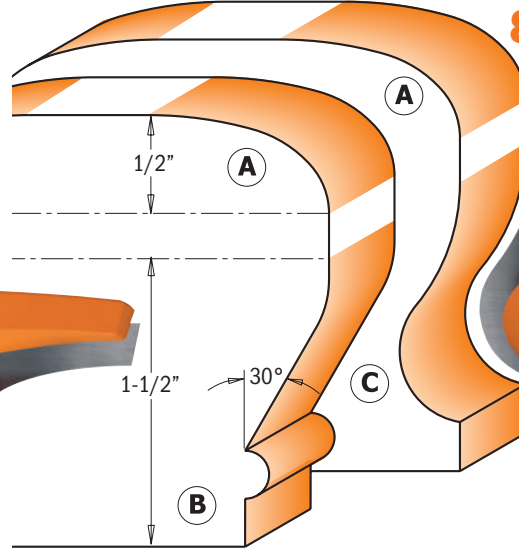

**856.702**



ORDER NO.		D	I	L	PROFILE	
S=01/2" shank		inches	mm	inches		
<b>856.601.11</b>	5	2-1/2	63.5	3/4	2-11/16	A
<b>856.701.11</b>	10	1-3/8	35	1-1/2	3-7/16	B
<b>856.702.11</b>	10	1-1/4	31.7	1-1/2	3-13/32	C

**Spare parts**

990.423.00	791.003.00	990.058.00	991.057.00
990.423.00	791.003.00	990.058.00	991.057.00
990.423.00	791.018.00	990.058.00	991.057.00

**SHOP TIPS:** after resharpening, replace bearing 791.003.11 (Ø12.7mm) with undersized bearing **791.063.00** (Ø12.5mm)

# Vertical Raised Panel Bits

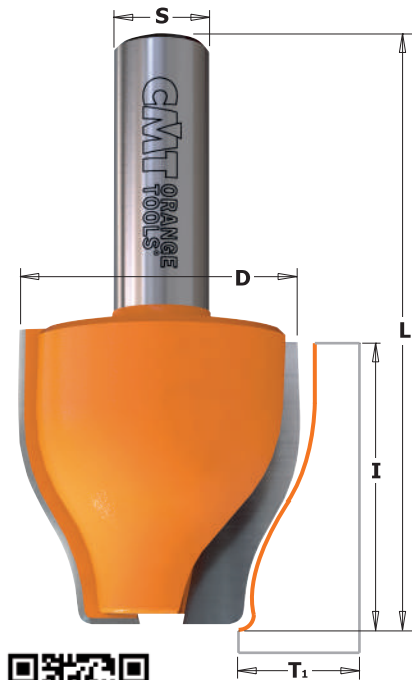

**890.6**



Use a sturdy 90° angle fence on your router table along with routers with a minimum speed of 1.7 KW (2-1/4 HP). Routers as low-powered as 1.1 KW (1-1/2 HP) can be used but we suggest limiting their use to shorter, shallower runs.

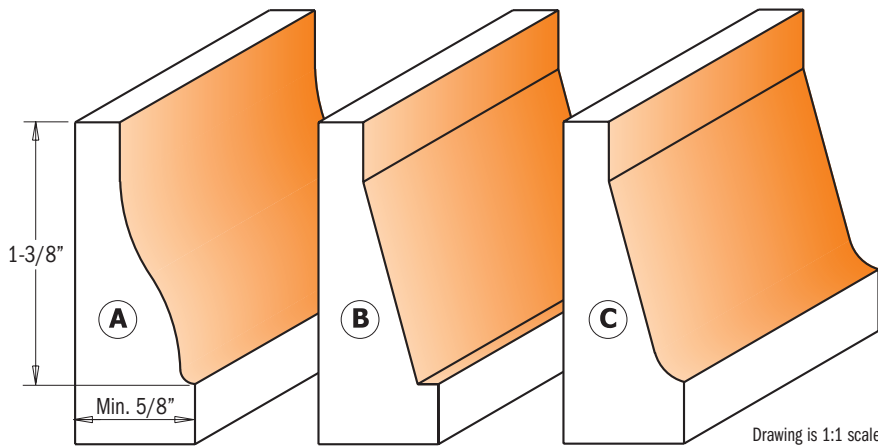

**SAFETY TIPS:** the template must be at least 6" (150mm) and clamps should be used whenever possible. Three to five passes are recommended to safely and accurately obtain the profile you desire.

ORDER NO.		D	I	T <sub>1</sub>	L	PROFILE
S=01/2" shank		inches	mm	inches	inches	
<b>890.601.11</b>	10	1-1/2	38.1	1-1/2	19/32-23/32	A
<b>890.602.11</b>	10	1-1/2	38.1	1-1/2	19/32-23/32	B
<b>890.603.11</b>	10	1-1/2	38.1	1-1/2	19/32-23/32	C



# Rail & Stile Sets

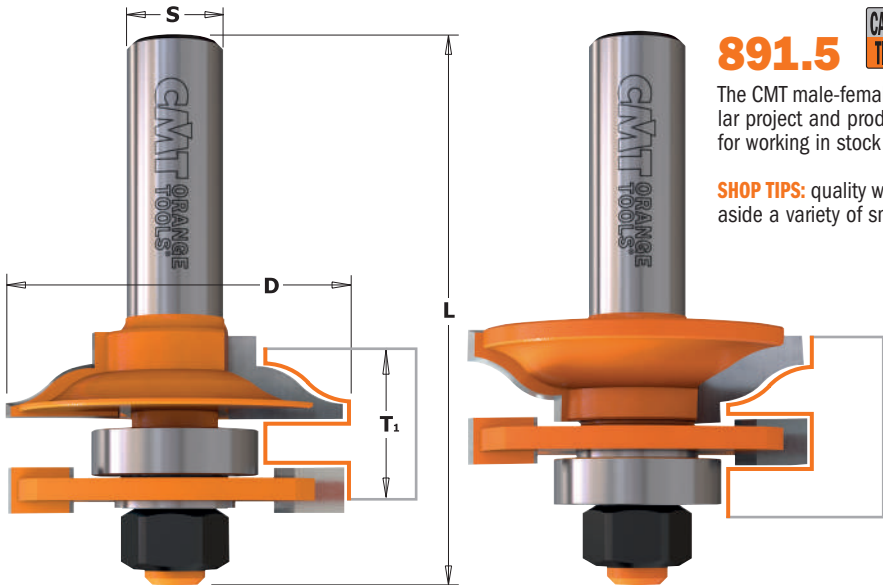

**891.5**



The CMT male-female rail and stile sets are a perfect pair for this particular project and produce clean, precise and well-crafted joints. Designed for working in stock from 11/16" to 7/8".

**SHOP TIPS:** quality workmanship is the result of a lot of trial and error. Set aside a variety of small pieces for trial cuts.

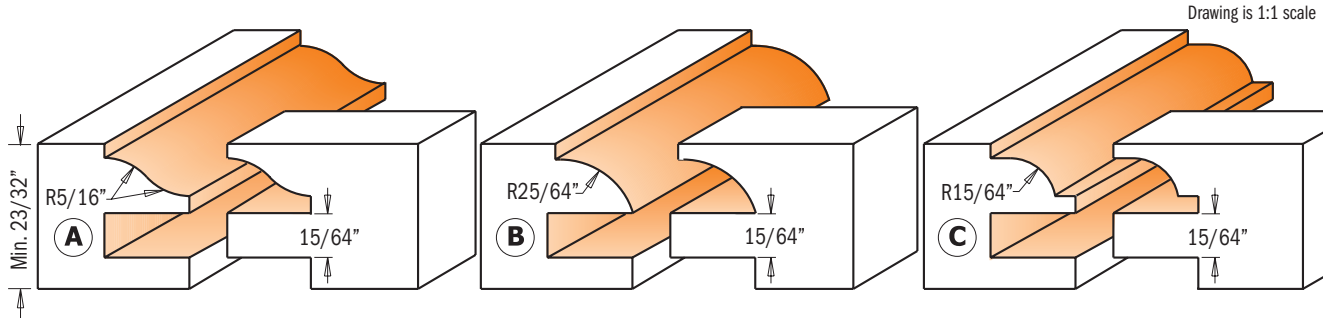

Drawing is 1:1 scale

ORDER NO.	S=01/2" shank	D		T <sub>1</sub>	L	PROFILE	Spare parts					
		inches	mm				822.003.11	791.012.00	0.1mm	0.3mm	0.9mm	990.407.00
<b>891.501.11</b>	5	1-3/4	44.5	23/32 - 7/8	2-51/64	A	822.003.11	791.012.00	541.515.00	514.516.00	990.407.00	990.020.00
<b>891.502.11</b>	5	1-3/4	44.5	23/32 - 7/8	2-51/64	B	822.003.11	791.012.00	541.515.00	514.516.00	990.407.00	990.020.00
<b>891.503.11</b>	5	1-3/4	44.5	23/32 - 7/8	2-51/64	C	822.003.11	791.012.00	541.515.00	514.516.00	990.407.00	990.020.00

## THE ABC'S OF PANEL DOOR CONSTRUCTION (PART 1)

In our step-by-step example of panel door construction, we used the following:

- CMT Rail & Stile set (item #891.502.11)
- CMT Reverse Glue Joint (item #855.501.11)
- pre-cut to length stiles - 3/4" thick x 2-1/4" wide
- pre-cut to length rails - 3/4" thick x 2-1/4" wide
- panel - 5/8" thick
- scrap stock for test cuts

The CMT Rail & Stile set was designed primarily for the construction of panel doors with 3/4" thick rails and stiles, but stock up to 7/8" thick can be used. Remember to adjust your measurements and cutting depths according to the wood thickness you use.

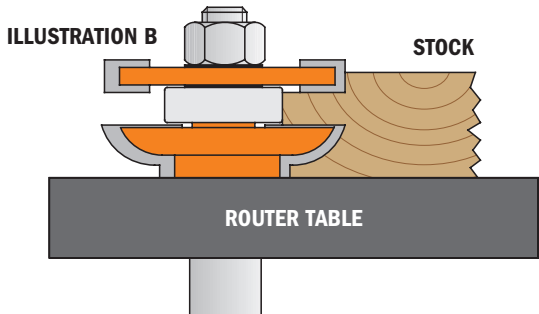
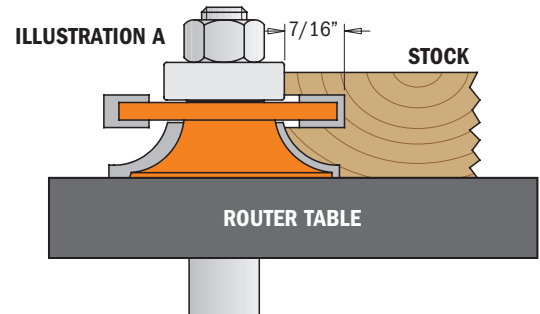
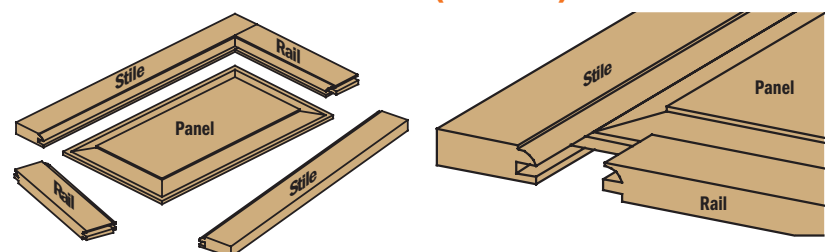

# One-Piece Rail & Stile Bit

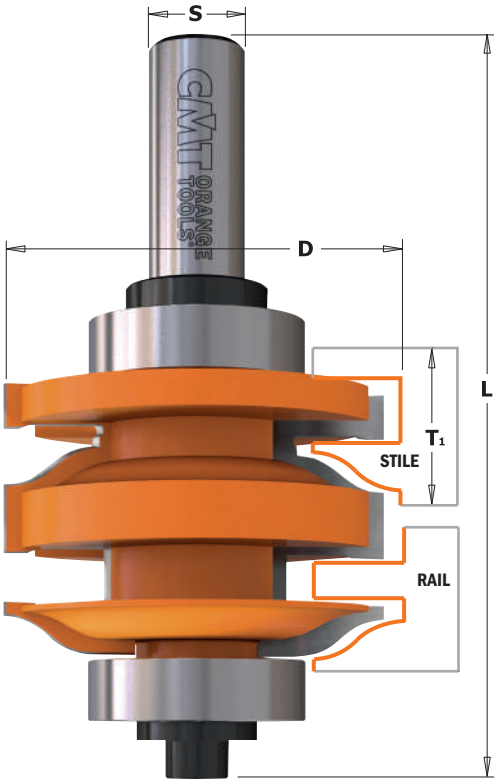

## 891.521



The new CMT One-Piece Rail and Stile Bit represents the union of two cutters in one bit. By simply adjusting the height of the bit, you can cut two perfectly joining profiles with no wasted time or effort moving the fence or changing the bit. Save time and money by investing in one single CMT cutting tool.

**SHOP TIPS:** the complicated nature of this kind of project requires a lot of practice and you need to carry out trial cuts. Always keep a variety of test pieces on hand.

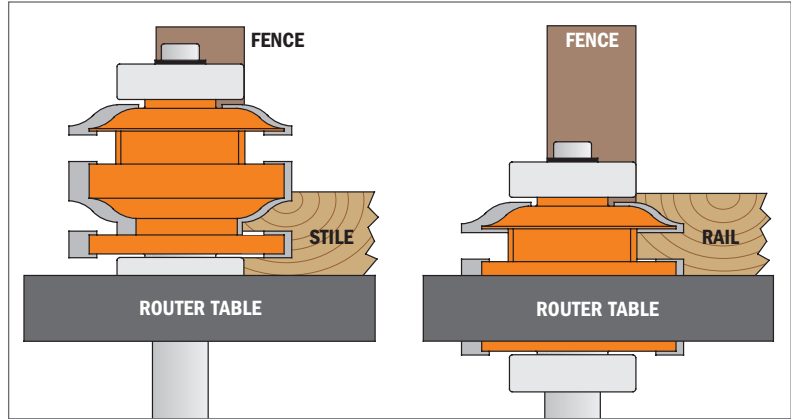

ORDER NO.		D		T <sub>1</sub>	L
S=Ø1/2" shank		inches	mm	inches	inches
891.521.11	10	2	50.8	23/32 - 7/8	3-25/32

### Spare parts

791.027.00	541.002.00	990.005.00	991.056.00	541.551.00	990.010.00	991.064.00

## THE ABC'S OF PANEL DOOR CONSTRUCTION (PART 2)

### CREATING THE RAILS AND STILES

First, make trial cuts of the cope profile (rail) and the stick profile (stile) in scrap stock. Then check the accuracy of the joint. This is extremely important, especially when working at the maximum thickness of 7/8". Make sure your stock is flat and cut straight with square edges. Using the CMT Stile Bit shown in illustration A, place the stock face down on the router table and mill the stick profile in the stile and rail pieces. To mill the rails, use the CMT Rail Bit shown in illustration B, position the rails face down on the router table and mill the cope profile in the ends. Before cutting the rails to length, be sure to allow enough length for the overlap of the cope and stick profiles. The stiles are the same length as the door. The rails must be calculated by the following equation (CMT standard tenon length is 7/16"):

$$(\text{total door width} - \text{sum of stile widths}) + \text{sum of 2 tenons} = \text{total rail length}$$

Therefore, using our example measurements listed above, for a 12" wide cabinet door:

$$12" - 4 - 1/2" + 7/8" = 8 - 3/8" \text{ rail length.}$$

### GLUING UP PANELS

If the panel requires a width greater than the width of your stock, you will need to edge glue stock for the central floating panel. This is easily accomplished using the CMT Reverse Glue Joint bit. For a two panel glue joint, place the first panel face down on the router table and accurately centre the wood to the bit: Adjust the bit according to the thickness of the wood you are cutting by lining up the cut edge of the wood to the center point of the bit as illustrated in illustration B and mill the cut edge of the wood. Place the second panel face up and repeat the milling process. This assures you will have the best side of your stock as a front face. If a third panel is required, mill one cut edge of the piece as instructed above, turn the piece over and run the other edge. Assemble the reverse cut pairs together for beautiful, strong joints that match up perfectly.

### MILLING THE FLOATING PANEL

To cut your panel to size be sure to make the proper calculations, taking into account the length of the tongue. The CMT Raised Panel Bit in our example has a standard tongue length of 5/16" (The New CMT Raised Panel Bit profile has a 3/8" tongue). Use the following equation:

$$(\text{Total door length} - \text{Sum of Stile widths}) + \text{Sum of 2 Tongues} = \text{Overall Panel Length}$$

Therefore, using our example measurements listed above for a 24" long cabinet door:  $(24 - 4 - 1/2") + 5/8" = 20 - 1/8"$  panel length

And accordingly:  $(\text{Total door width} - \text{Sum of Stile widths}) + \text{Sum of 2 Tongues} = \text{Overall Panel Width}$

Once the panel has been cut to proper dimensions, position the panel face side down on the router table as shown in illustration C and use the CMT Raised Panel Bit to mill the tongue. ATTENTION: this bit is capable of removing large amounts of stock. To safely and effectively produce the profile you want, we suggest making several shallow passes. It can be dangerous to try to mill the entire profile in a single cut.

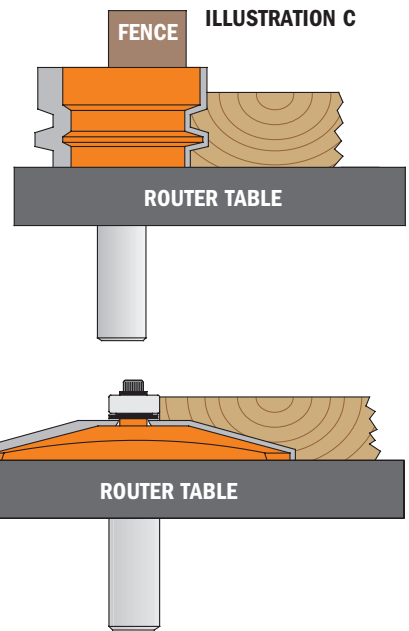

# Junior Ogee Rail & Stile Set

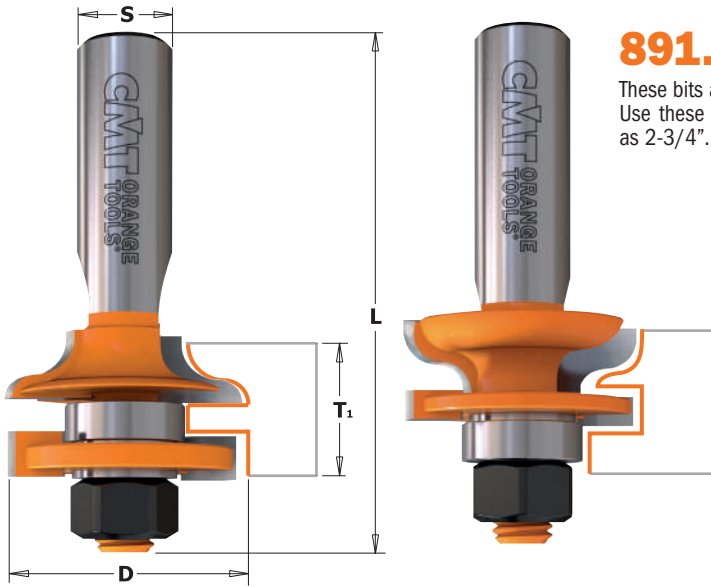

**891.517**



These bits are designed for those special projects that require a smaller panel door. Use these bits with stock from 7/16" to 11/16" thick, and build doors as small as 2-3/4".

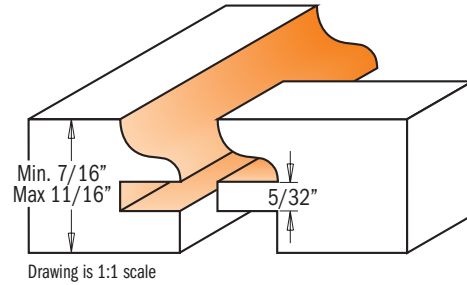

ORDER NO.		D		T <sub>1</sub>	L
S=01/2" shank		inches	mm	inches	inches
891.517.11	5	1-1/4	31.7	7/16 - 11/16	2-41/64

**Spare parts**

	5/32"		15/64"		
822.008.11		822.009.11		791.025.00	990.020.00

Spare parts: 541.515.00 0.1mm spacer  
541.516.00 0.3mm spacer  
541.518.00 1.0mm spacer

# Rail & Stile Set

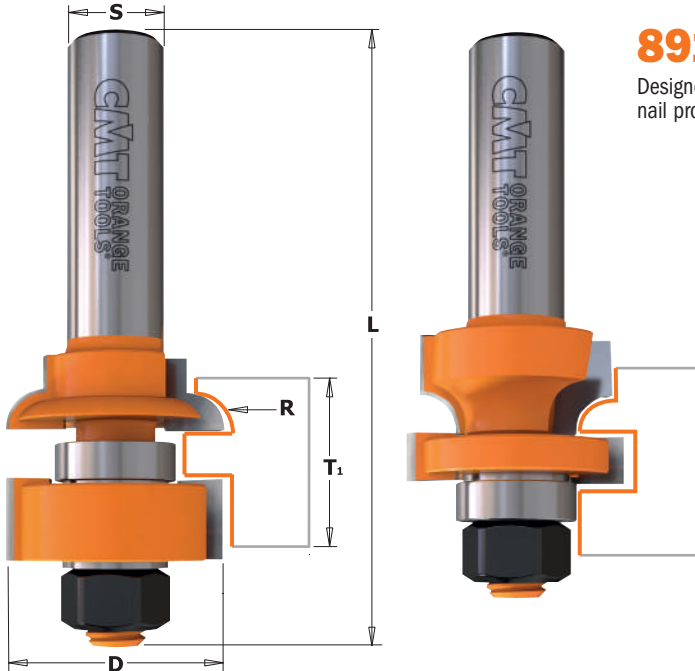

**891.512**



Designed for fine furniture construction, these bits mill a delicate 3/16" thumb-nail profile in stock from 5/8" to 13/16".

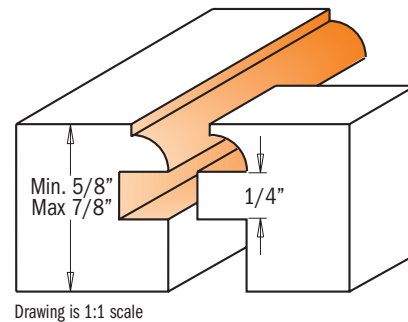

ORDER NO.		D		R	T <sub>1</sub>	L
S=01/2" shank		inches	mm	inches	inches	inches
891.512.11	10	1-1/8	28.7	3/16	5/8 - 7/8	3-1/8

**Spare parts**

	1/4"		27/64"		
822.011.11		822.012.11		791.025.00	990.020.00

Spare parts: 541.515.00 0.1mm spacer  
541.516.00 0.3mm spacer  
541.518.00 1.0mm spacer

# Raised Panel Bits

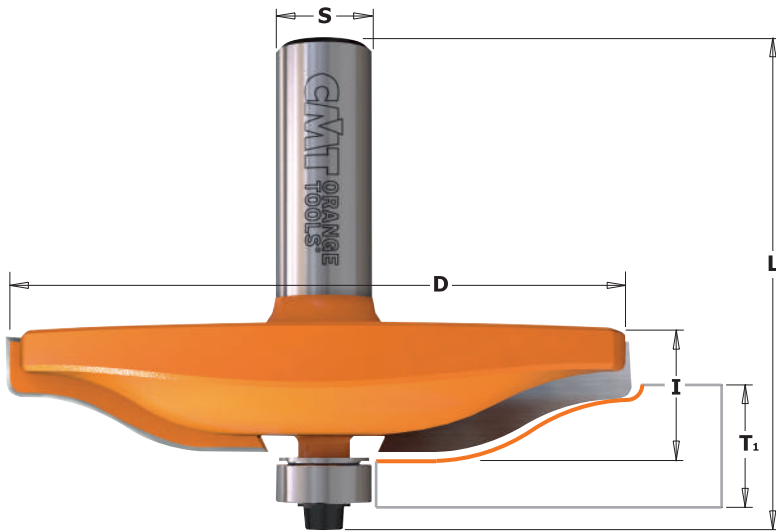

## 890

Make classic raised panel doors by choosing from the profiles illustrated below. Its anti-kickback design is fundamental in further improving safety when working with larger diameter bits.

**SAFETY TIPS:** this type of bit needs to be used at a lower rotational speed, preferably between 10,000 and 12,000 RPMs. Three to five passes are recommended to safely and accurately obtain the profile you desire. To be used on routers with at least 1800 Watt or 2-1/4 HP.

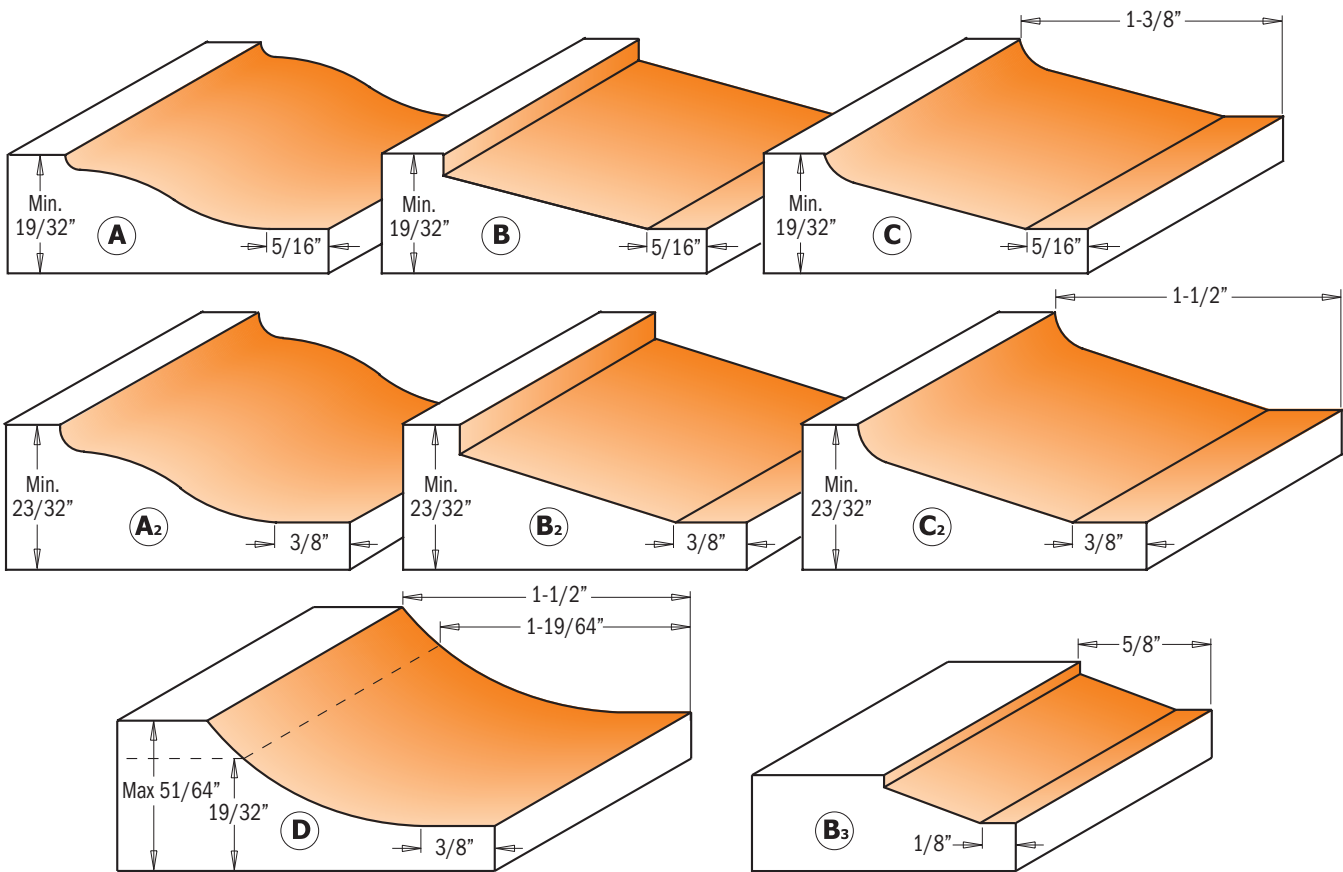

ORDER NO.		D	I	T <sub>1</sub>	L	PROFILE	
S=01/2" shank		inches	mm	inches	inches		
890.501.11	5	3-1/4	82.5	19/32	19/32 - 23/32	2-1/2	A
890.502.11	5	3-1/4	82.5	19/32	19/32 - 23/32	2-1/2	B
890.503.11	5	3-1/4	82.5	19/32	19/32 - 23/32	2-17/32	C
890.504.11	5	3-1/2	89	19/32	23/32 - 25/32	2-17/32	A <sub>2</sub>
890.505.11	5	3-1/2	89	19/32	23/32 - 25/32	2-17/32	B <sub>2</sub>
890.506.11	5	3-1/2	89	19/32	23/32 - 25/32	2-17/32	C <sub>2</sub>
890.507.11	5	3-1/2	89	19/32	23/32 - 25/32	2-17/32	D
890.512.11	10	1-7/8	47.6	3/8	1/2 - 19/32	2-9/32	B <sub>3</sub>

### Spare parts

990.423.00	791.003.00	990.058.00	991.057.00
990.423.00	791.003.00	990.058.00	991.057.00
990.423.00	791.003.00	990.058.00	991.057.00
990.423.00	791.003.00	990.058.00	991.057.00
990.423.00	791.003.00	990.058.00	991.057.00
990.423.00	791.003.00	990.058.00	991.057.00
990.423.00	791.003.00	990.058.00	991.057.00
990.423.00	791.003.00	990.058.00	991.057.00



# Raised Panel Bit with Back Cutter



## 890.5



These bits have a back-cutter which allows you to rout both the front and back of the panel in the same cut which saves time and money.

**SAFETY TIPS:** to ensure improved safety when using the  $\varnothing 3\text{-}1/2"$  ( $\varnothing 89\text{mm}$ ) bit, carry out the cut in 2 shallow passes: use a  $1\text{-}29/64"$  ( $\varnothing 37\text{mm}$ ) bearing for the first pass, and then a  $5/8"$  ( $\varnothing 16\text{mm}$ ) bearing for the second pass.

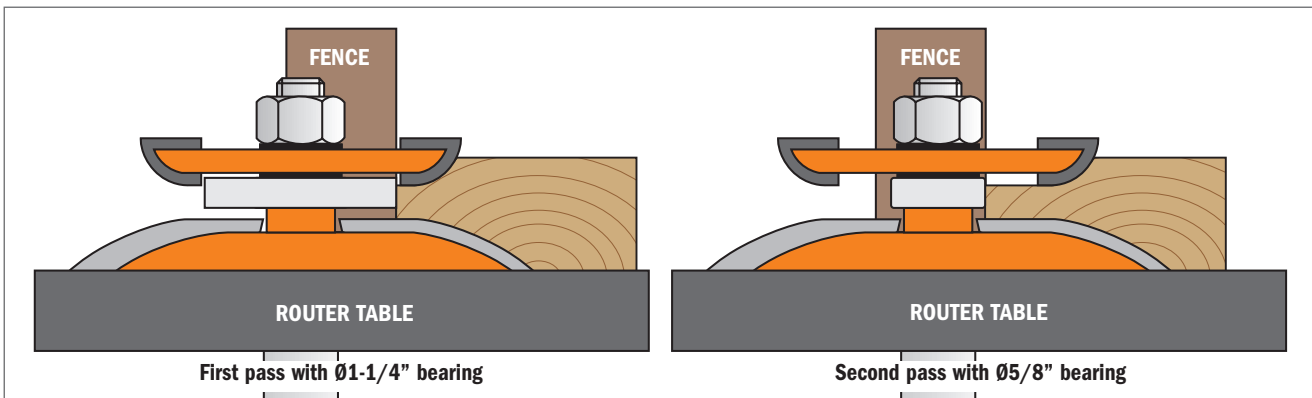
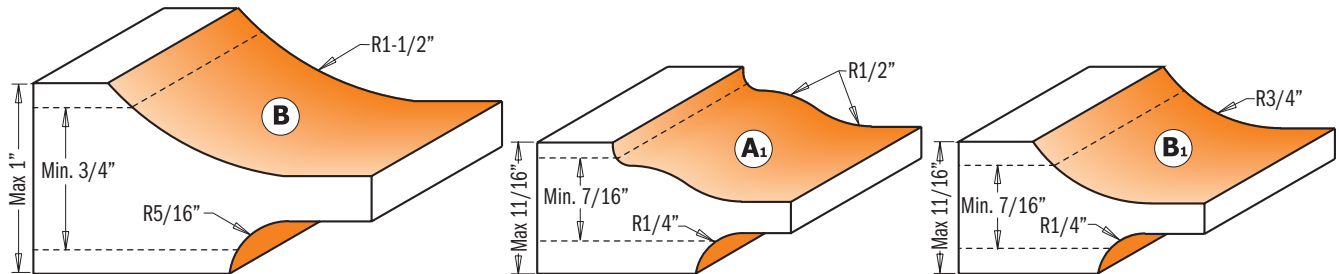
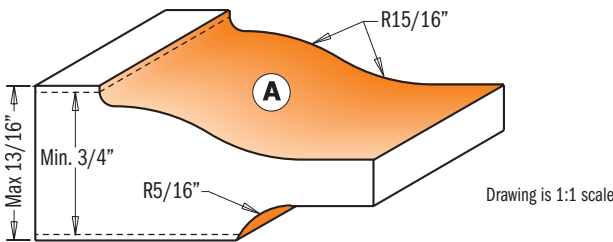
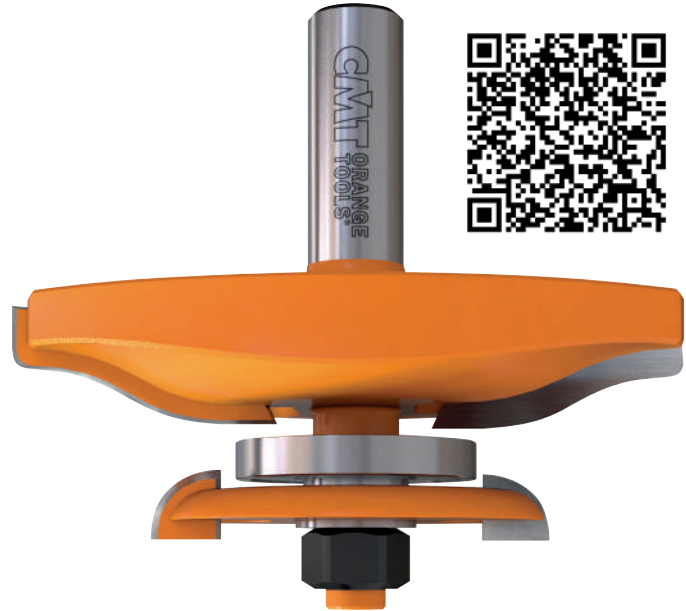
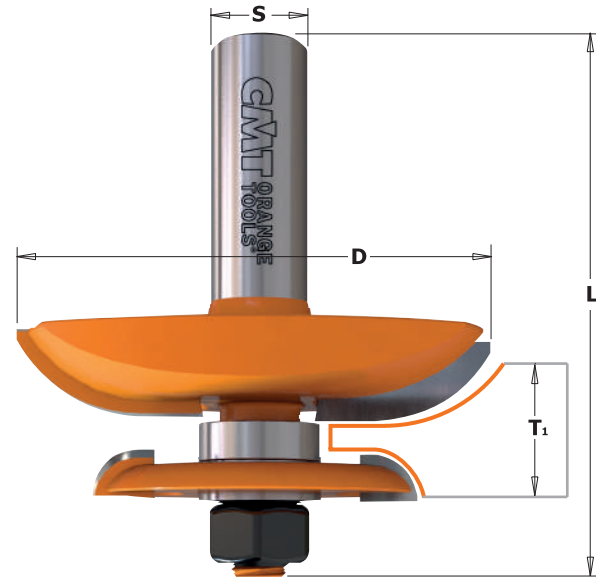

ORDER NO.		D		T <sub>1</sub>	L	PROFILE
S=Ø1/2" shank		inches	mm	inches	inches	
890.524.11	5	3-1/2	89	3/4 - 13/16	3-5/64	A
890.527.11	5	3-1/2	89	3/4 - 1	3-5/64	B
890.534.11	5	2-1/2	63.5	7/16 - 11/16	2-3/4	A <sub>1</sub>
890.537.11	5	2-1/2	63.5	7/16 - 11/16	2-3/4	B <sub>1</sub>

### Spare parts

	16mm	31.7mm	
822.007.11	791.025.00	791.033.00	990.020.00
822.007.11	791.025.00	791.033.00	990.020.00
822.010.11	791.025.00		990.020.00
822.010.11	791.025.00		990.020.00

Spare parts: 541.515.00 0.1mm spacer  
541.516.00 0.3mm spacer

541.518.00 1.0mm spacer  
990.407.00 Shield conical

## 870

These bits can be used for decorative work on solid wood panels and MDF materials. Use them in one pass or in combination with CMT's MDF panel bits for complex and intricate profiles. A simple approach for an elegant appearance.

Featuring large cutting diameters and available in the most popular profiles, these panel bits guarantee excellent performance.



### PANEL BITS

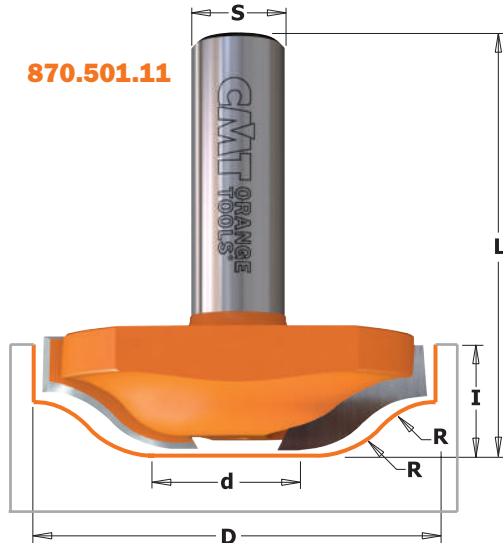

870.501.11



870.502.11



870.503.11

### STILE BITS

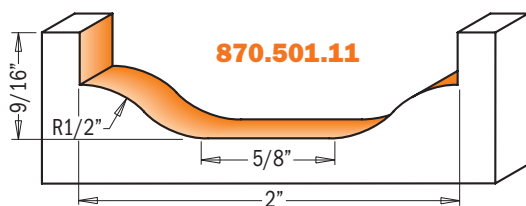

870.501.11

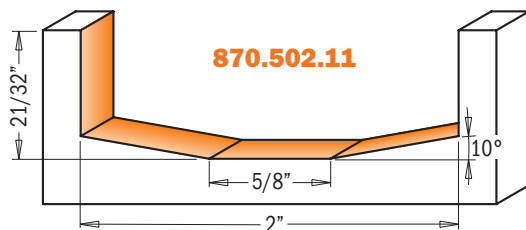

870.502.11

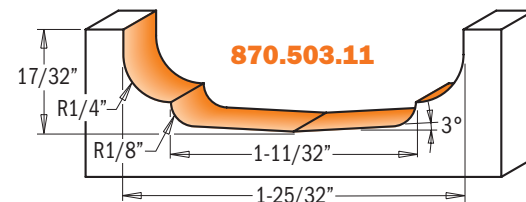

870.503.11

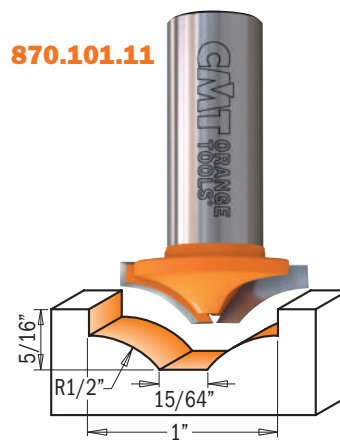

870.101.11

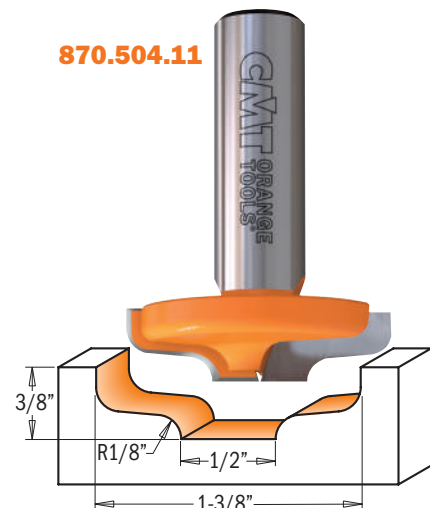

870.504.11

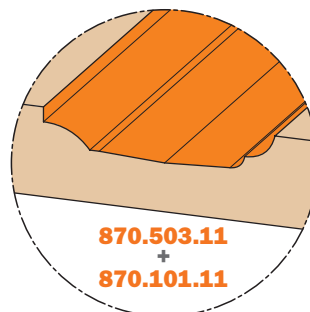

870.503.11 + 870.101.11

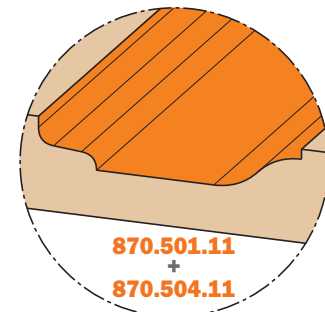

870.501.11 + 870.504.11

Drawing is 1:1 scale

ORDER NO.		D	d	I	R	A	L
S=01/2" shank		inches	mm	inches	inches		inches
870.101.11	10	63/64	25	15/64	5/16		1-9/16
870.501.11	10	2	50	5/8	9/16		2-1/16
870.502.11	10	2	50	5/8	43/64	10°	2-11/64
870.503.11	10	1-49/64	45	1-11/32	17/32	3°	2-1/32
870.504.11	10	1-3/8	35	1/2	3/8		1-7/8

## 3-Flute Slot Cutter for STRIPLIX® Mini

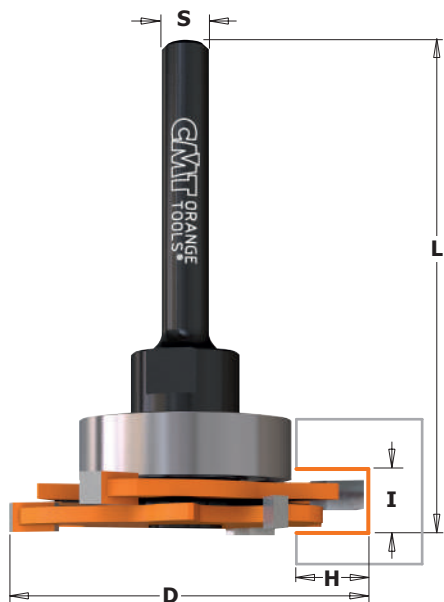

### 823.371

New CMT cutter for STRIPLIX® Mini connectors. These connectors are invisible joiners suited to everyday projects, custom cabinets, wood joints and any piece of cabinetry, furniture or design application. They produce tight and strong joints either in permanent or temporary structures making them perfectly suited for commercial, fit-outs, domestic and architectural furniture, kitchen, bathroom, wardrobe closets and cabinetry.

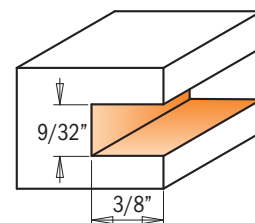

Drawing is 1:1 scale



ORDER NO.		I	D	H	L
S=Ø1/4" shank		inches mm	inches	inches	inches
<b>823.371.11A</b>	<b>10</b>	9/32 7	1-7/8	3/8	2-9/16

#### Spare parts

			
791.030.00	823.340.11	990.055.00	991.067.00

Spare parts: 541.515.00 0.1mm spacer  
541.516.00 0.3mm spacer  
541.517.00 0.5mm spacer

## Solid Surface - Counter-Top Trim Router Bits

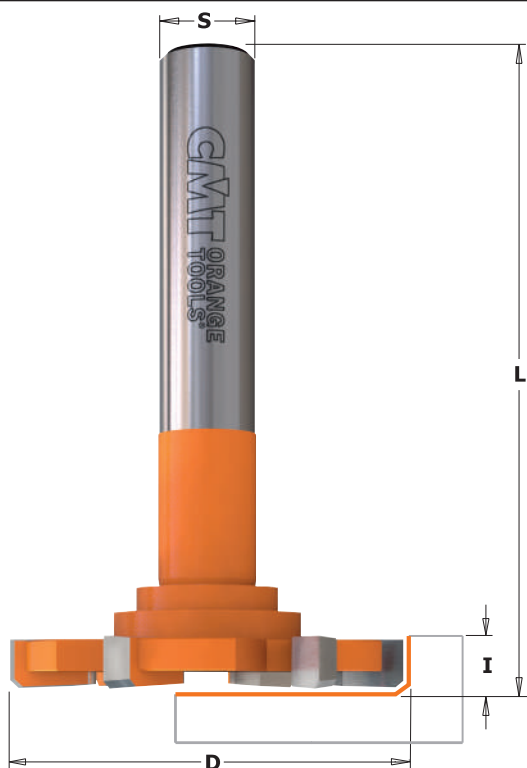

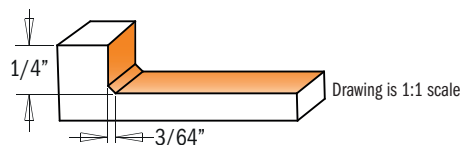

### 822.034

Create even shallow recesses in countertops with this 6-wing tool. The radiused cutting tips produce an edge that's super smooth to the touch and simple to clean. For use with handheld routers.

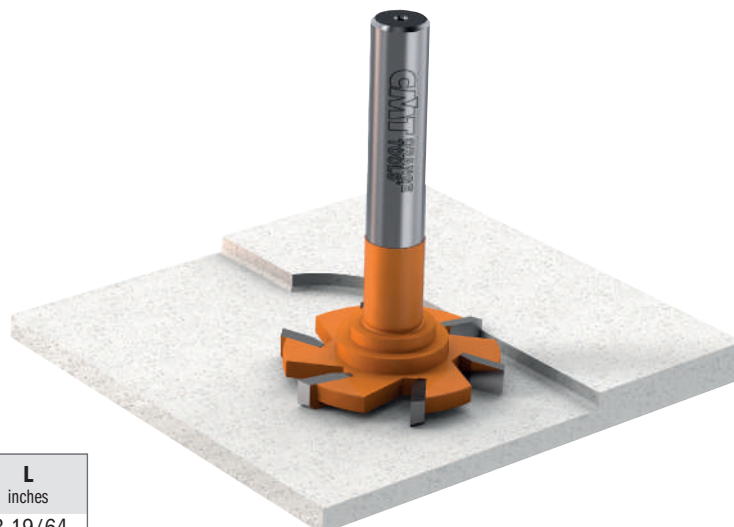

Drawing is 1:1 scale



ORDER NO.		D	I	L
S=Ø1/2" shank		inches mm	inches	inches
<b>822.034.11</b>	<b>5</b>	2-3/64 52	1/4	3-19/64

# Solid Surface - Decorative Edge Profile Bits

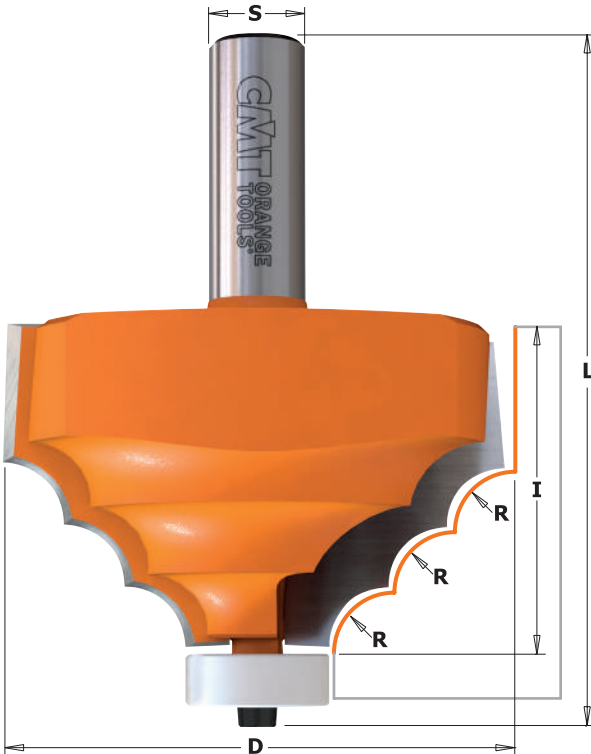

**880.521**



Create elegant countertops with flawless results. Features a non-marring DELRIN® bearing to protect the finished edges. For use on hand-held portable routers.

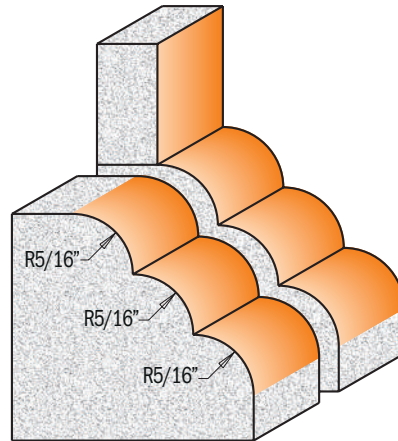

Drawing is 1:1 scale

**APPLICATION**  
 WILSONART®  
 GIBRALTAR®  
 CORIAN®  
 SURELL®  
 FOUNTAINHEAD®  
 AVONITE®  
 FORMICA®  
 Etc.

ORDER NO. S=01/2" shank	Box	D		I	R	L	Spare parts		
880.521.11	5	inches	mm	inches	inches	inches			
		2-5/8	66.7	1-5/8	5/16	3-17/32	791.046.00	990.058.00	991.057.00

# Solid Surface - Rounding Over Bits

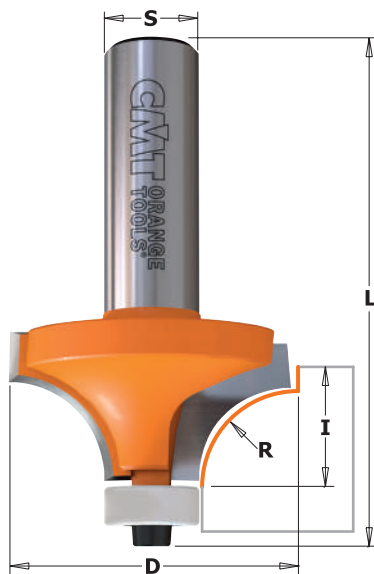

**838 - 880.5**



Use these bits to create traditional roundover edges on solid surface countertops. Equipped with a non-marring DELRIN® bearing to protect finished edges. For use on hand-held portable routers.

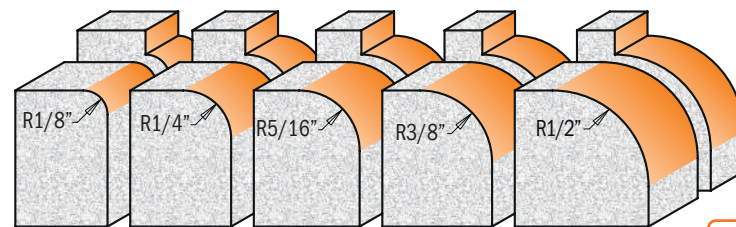

Drawing is 1:1 scale

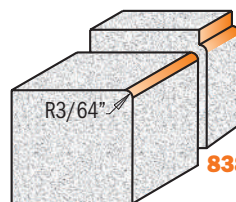

**838.147.11**

**APPLICATION**  
 WILSONART®  
 GIBRALTAR®  
 CORIAN®  
 SURELL®  
 FOUNTAINHEAD®  
 AVONITE®  
 FORMICA®  
 Etc.

ORDER NO. S=01/4" shank	ORDER NO. S=01/2" shank	Box	D		I	R	L	Spare parts		
838.147.11		10	inches	mm	inches	inches	inches			
	880.501.11	10	3/4	19.05	1/2	1/8	2-11/32	990.422.00	791.044.00	990.058.00
	880.502.11	10	1	25.4	1/2	1/4	2-11/32	990.422.00	791.044.00	990.058.00
	880.505.11	10	1-1/8	28.7	19/32	5/16	2-29/64	990.422.00	791.044.00	990.058.00
	880.503.11	10	1-1/4	31.75	9/16	3/8	2-25/64	990.422.00	791.044.00	990.058.00
	880.504.11	10	1-1/2	38.1	3/4	1/2	2-19/32	990.422.00	791.044.00	990.058.00

Spare parts: 991.057.00 3/32" hex key



# Solid Surface - Rounding Over Bowl Bits

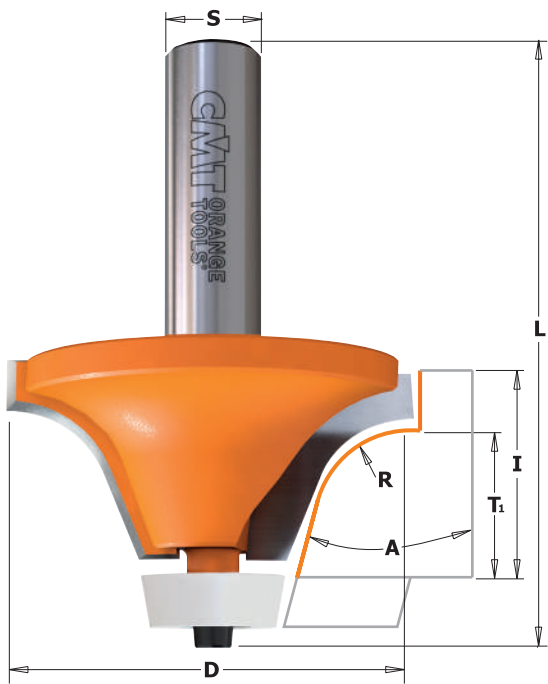

**866.6 - 880.541**



These bits are the best tool for rounding over and trimming countertop edges after the bowl is mounted. Can be used together with the CMT 880.551.11 bevel cutter for a flush cut-out between the countertop and the installed undermount bowl. For use on hand-held routers. Features a non-marring DELRIN® bearing to protect the finished edges as well as surfaces.

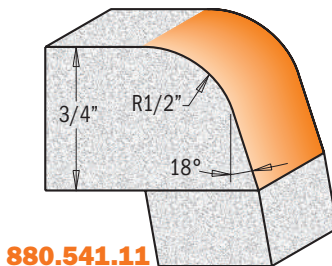

**880.541.11**

**APPLICATION**  
 WILSONART®  
 GIBRALTAR®  
 CORIAN®  
 SURELL®  
 FOUNTAINHEAD®  
 AVONITE®  
 FORMICA®  
 Etc.

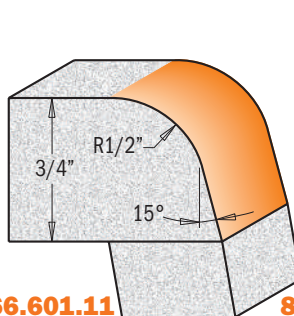

**866.601.11**

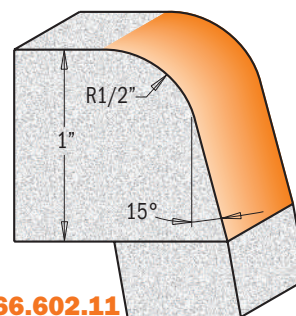

**866.602.11**

Drawing is 1:1 scale

ORDER NO. S=Ø1/2" shank	Box	D	T <sub>1</sub>	I	R	A	L
		inches	mm	inches	inches	inches	inches
866.601.11	10	2	50.8	3/4	1	1/2	2-61/64
866.602.11	10	2	50.8	1	1-1/4	1/2	3-13/64
880.541.11	10	2-1/8	54	3/4	1	1/2	3-5/64

**Spare parts**

791.041.00	990.058.00	991.057.00
791.041.00	990.058.00	991.057.00
791.041.00	990.058.00	991.057.00

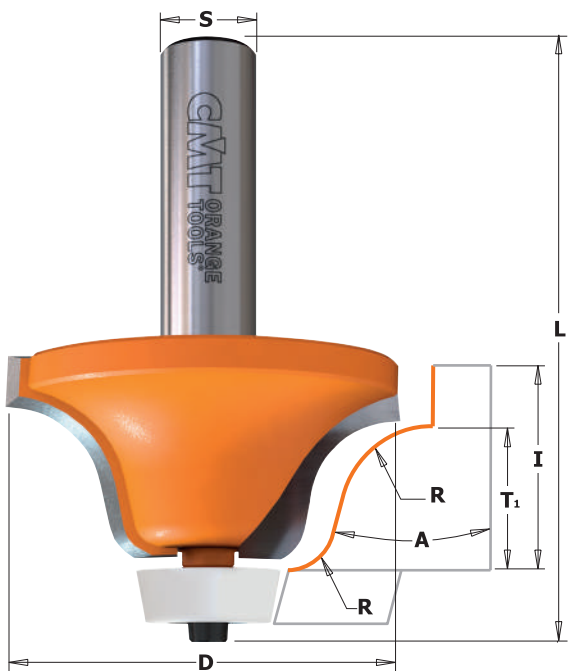

## Solid Surface - Rounding Over Bowl Bit (ogee profile)

**880.542**



These bits roundover and trim the countertop edges after the bowl is mounted. Can be used with the CMT 880.551.11 bevel cutter for a flush cut-out between the countertop and installed undermount bowl. For use on hand-held portable routers. Features a non-marring DELRIN® bearing to protect the finished edges.

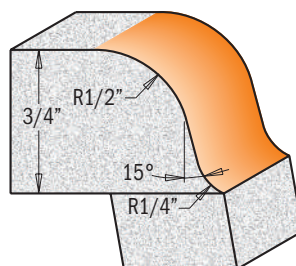

Drawing is 1:1 scale

**APPLICATION**  
 WILSONART®  
 GIBRALTAR®  
 CORIAN®  
 SURELL®  
 FOUNTAINHEAD®  
 AVONITE®  
 FORMICA®  
 Etc.

ORDER NO. S=Ø1/2" shank	Box	D	T <sub>1</sub>	I	R	A	L
		inches	mm	inches	inches	inches	inches
880.542.11	10	2-1/8	54	3/4	1	1/4 - 1/2	3-1/16

**Spare parts**

791.041.00	990.058.00	991.057.00

# Solid Surface - Bevel Bowl Bits

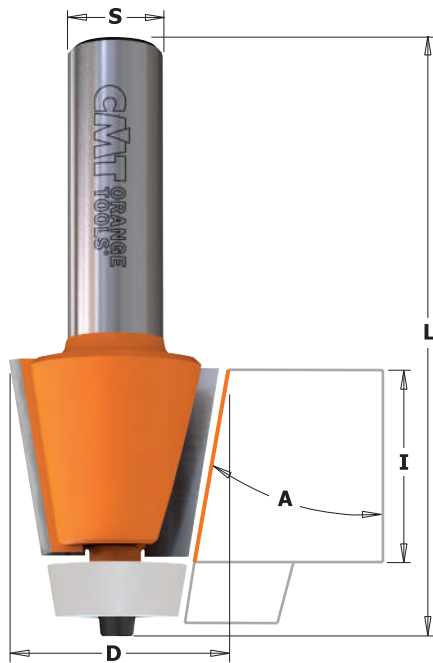

## 866.501 - 880.551



These bits are designed for undermount applications joining the countertops and sink bowls with a beveled edge. Can be used with the **880.541.11** and **880.542.11** for complete undermount applications.

For use on hand-held routers. Features a non-marring DELRIN® bearing to protect the finished edges and surfaces.

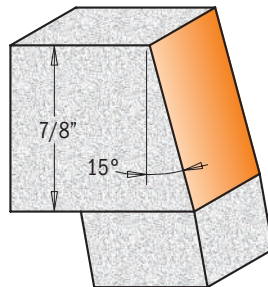

**866.501.11**

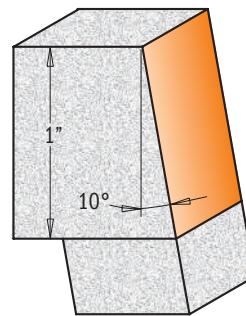

**880.551.11**

**APPLICATION**  
 WILSONART®  
 GIBRALTAR®  
 CORIAN®  
 SURELL®  
 FOUNTAINHEAD®  
 AVONITE®  
 FORMICA®  
 Etc.

Drawing is 1:1 scale

ORDER NO.		D		I	A	L
S=01/2" shank		inches	mm	inches		inches
<b>866.501.11</b>	10	1-1/4	31.7	7/8	15°	2-53/64
<b>880.551.11</b>	10	1-1/8	28.5	1	10°	3-1/32

**Spare parts**

791.041.00	990.058.00	991.057.00
791.041.00	990.058.00	991.057.00

# 4-Wing Cut Out Slot Cutters for Solid Surfaces

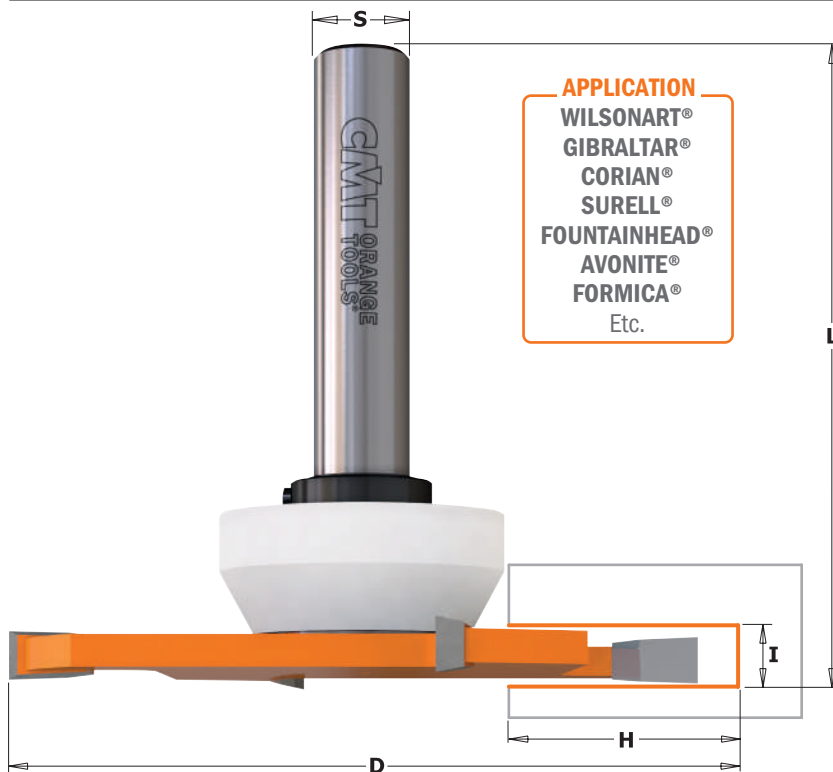

**APPLICATION**  
 WILSONART®  
 GIBRALTAR®  
 CORIAN®  
 SURELL®  
 FOUNTAINHEAD®  
 AVONITE®  
 FORMICA®  
 Etc.

## 822.033B

This bit features two tungsten carbide-tipped cutting edges for carving out solid surface undermount bits in composite. For use on hand-held routers. Bit also equipped with a non-marring DELRIN® bearing to protect your surfaces.

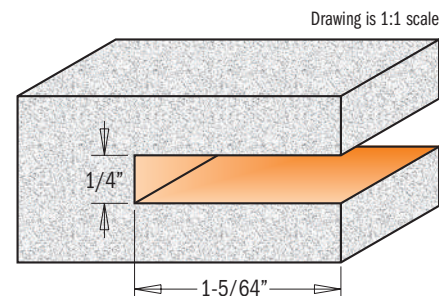

Drawing is 1:1 scale

ORDER NO.		D		I	H	L
S=01/2"		inches	mm	inches	inches	inches
<b>822.033.11B</b>	5	3-5/8	92	1/4	1-5/64	3-1/4

**Spare parts**

541.553.00	791.047.00	541.002.00	991.056.00

# Solid Surface - Bevel Bit



## 881.521

Edge profile bit designed to create a 15° beveled edge on solid surface countertops. Can also be used for European type topmount installation with sinks and bowls. For use on hand-held portable and table routers.

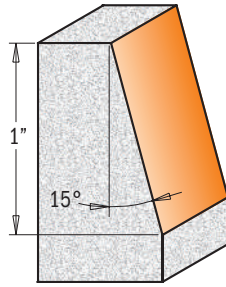

Drawing is 1:1 scale

**APPLICATION**  
 WILSONART®  
 GIBRALTAR®  
 CORIAN®  
 SURELL®  
 FOUNTAINHEAD®  
 AVONITE®  
 FORMICA®  
 Etc.

ORDER NO.		D	I	A	d	L	
S=01/2" shank		inches	mm	inches	inches	inches	
881.521.11	10	29/32	23	1	15°	3/8	2-1/2

# Solid Surface - Cut & Plug Repair Set



Download the instructions

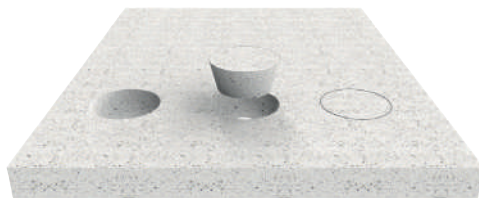
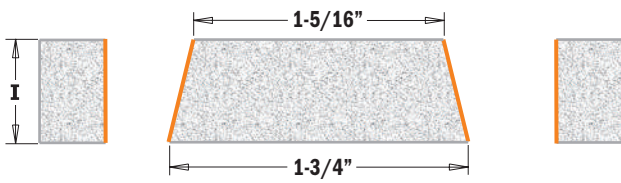
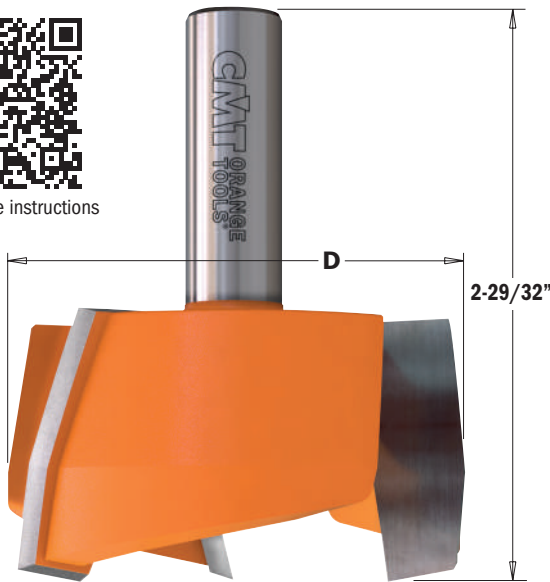

## 881.541

These special carbide-tipped bits work best on solid surfaces or when repairing damaged surfaces. One bit creates the plug, then the other bit easily carves out the hole. Your surfaces will look like new again! For use with hand-held routers or CNC machines.



**APPLICATION**  
 WILSONART®  
 GIBRALTAR®  
 CORIAN®  
 SURELL®  
 FOUNTAINHEAD®  
 AVONITE®  
 FORMICA®  
 Etc.

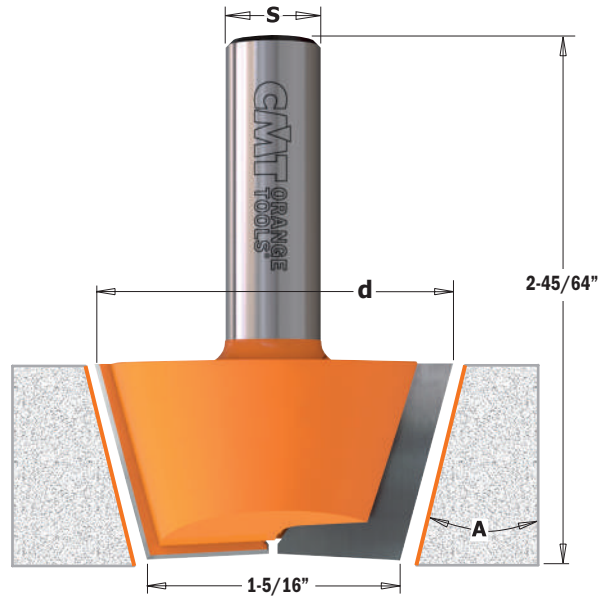

ORDER NO.		d	D	I	A	L		
S=01/2" shank		inches	mm	inches	mm	inches		
881.541.11	5	1-7/8	47.5	2-31/64	63	3/4	15°	2-45/64 - 2-29/32



# Solid Surface - No-Drip Bit



## 881.501

This bit is designed to create “no-drip” edges on kitchen and vanity countertops in one simple step. Designed for hand-held portable routers on applications where a guide bearing cannot be used. This one bit will cut both the outer and inner profiles creating a slightly raised edge, controlling spilled liquids.

**APPLICATION**  
 WILSONART®  
 GIBRALTAR®  
 CORIAN®  
 SURELL®  
 FOUNTAINHEAD®  
 AVONITE®  
 FORMICA®  
 Etc.

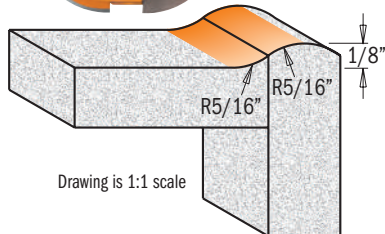
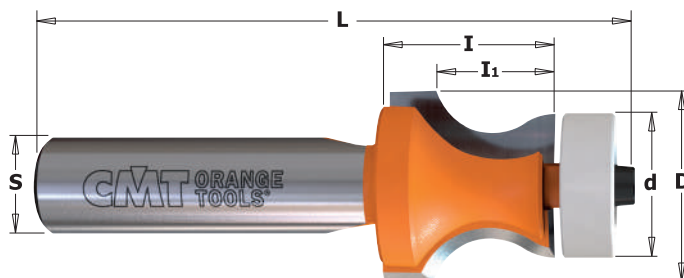

Drawing is 1:1 scale

## 880.531

This bit creates strong and reliable joints in a variety of composites thanks to greater surface area for applying glue.

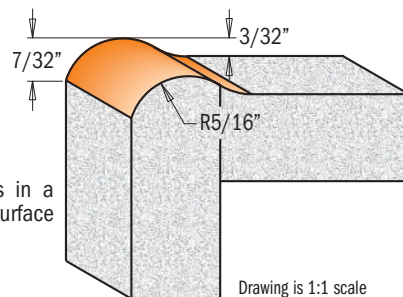

Drawing is 1:1 scale

ORDER NO. S=01/2" shank		D	d	I	I <sub>1</sub>	R	L
		inches	mm	inches	inches	inches	inches
881.501.11	10	1	25.4		1/2	1/8	2-1/2
880.531.11	10	1	25.4	3/4	7/8	5/16	3-1/32

Spare parts

791.046.00	990.058.00	991.057.00

# Solid Surface - Wavy Joint Bit

## 881.531

These bits are ideal for making strong joints on any solid surface, thanks to a wider surface area for glue application.



**APPLICATION**  
 WILSONART®  
 GIBRALTAR®  
 CORIAN®  
 SURELL®  
 FOUNTAINHEAD®  
 AVONITE®  
 FORMICA®  
 Etc.

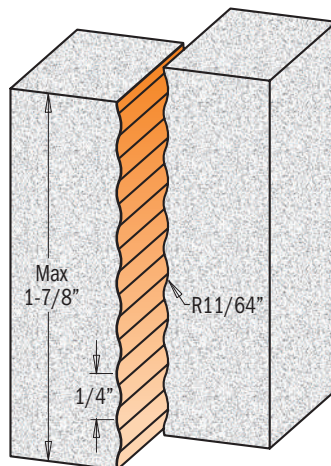
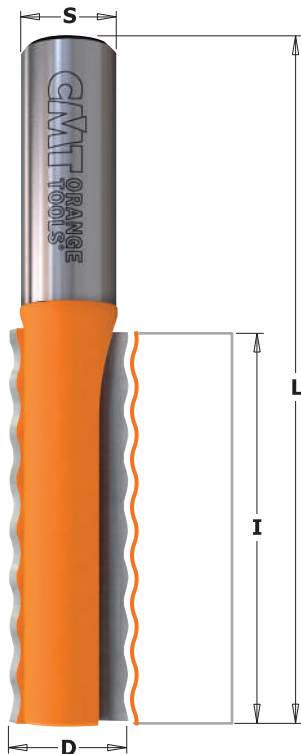

Drawing is 1:1 scale

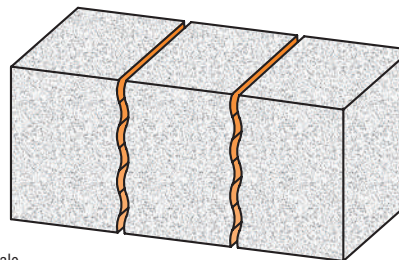

ORDER NO. S=01/2" shank		D	I	R	L
		inches	mm	inches	inches
881.531.11	10	5/8	15.87	2-1/32	3-1/2



# Solid Surface - Drainboard Bits

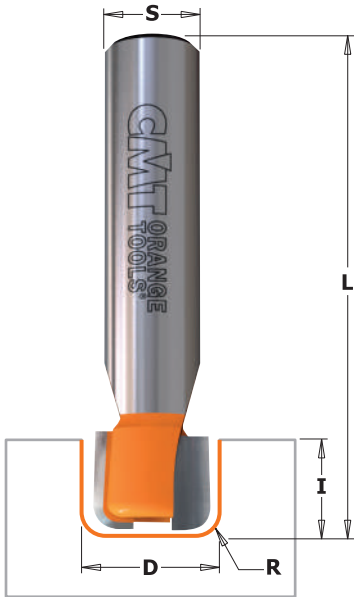

## 881.511-512

This bit is ideal for creating custom drainboard patterns in solid surface countertops. For use on hand-held portable routers.

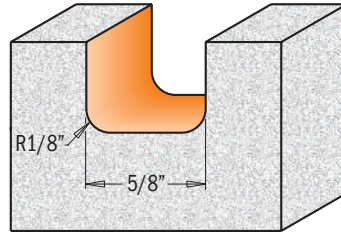

Drawing is 1:1 scale

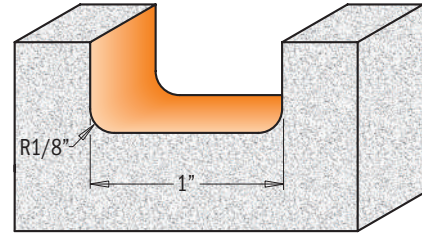

ORDER NO.		D	I	R	L	
S=01/2" shank		inches	mm	inches	inches	
881.511.11	10	5/8	15.87	1/2	1/8	2-1/2
881.512.11	10	1	25.4	1/2	1/8	2-3/4

### APPLICATION

- WILSONART®
- GIBRALTAR®
- CORIAN®
- SURELL®
- FOUNTAINHEAD®
- AVONITE®
- FORMICA®
- Etc.

# Solid Surface - Inlay Bits



## 880.511-512-513

Add a decorative inlay to solid surface countertops in composite. Equipped with a non-marring DELRIN® bearing to protect the finished edges. For use on hand-held portable and table routers.

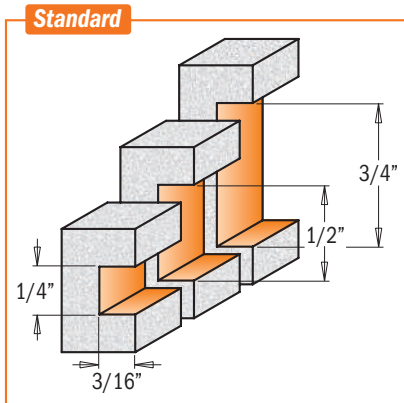

Drawing is 1:1 scale

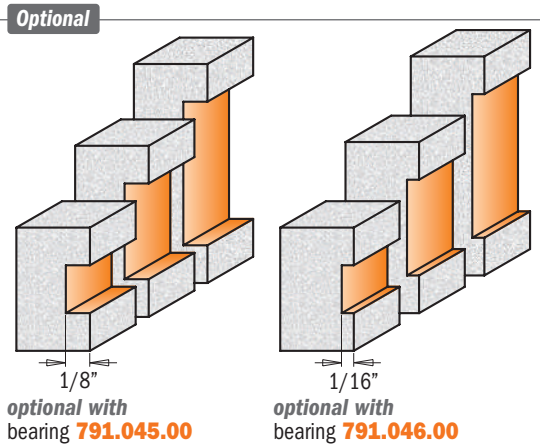

optional with bearing 791.045.00

optional with bearing 791.046.00

### APPLICATION

- WILSONART®
- GIBRALTAR®
- CORIAN®
- SURELL®
- FOUNTAINHEAD®
- AVONITE®
- FORMICA®
- Etc.

ORDER NO.		D	I	H	L	
S=01/2" shank		inches	mm	inches	inches	
880.511.11	10	7/8	22.2	1/4	3/16	3-3/32
880.512.11	10	7/8	22.2	1/2	3/16	3-19/32
880.513.11	10	7/8	22.2	3/4	3/16	3-19/32

### Spare parts

791.044.00	990.058.00	991.057.00
791.044.00	990.058.00	991.057.00
791.044.00	990.058.00	991.057.00

# Solid Surface - Sink & Trim Bits



## 880.57

Trim a sink cut-out flush with the bowl in stages using these “over-hang” and flush trim bits. The DELRIN® bearings are tapered to match the slope of the bowl’s side. A first pass with the over-hang bit cleans the cut-out edge, leaving a slight over-hang on the underside of the counter. A second pass with the flush-trim bit completes the operation. Made from super micrograin carbide for guaranteed longer life!

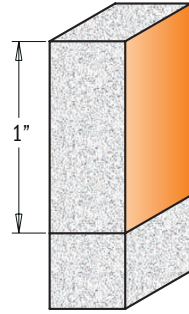

880.571.11

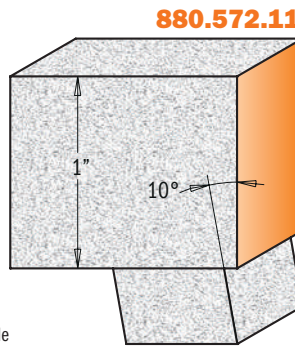

880.572.11

Drawing is 1:1 scale



**APPLICATION**  
 WILSONART®  
 GIBRALTAR®  
 CORIAN®  
 SURELL®  
 FOUNTAINHEAD®  
 AVONITE®  
 FORMICA®  
 Etc.

ORDER NO.		D	I	A	L
S=01/2" shank		inches	mm	inches	inches
880.571.11	10	3/4	19.05	1	3-1/16
880.572.11	10	7/8	22	10°	3-1/16

Spare parts

791.046.00	990.058.00	991.057.00
791.048.00	990.058.00	991.057.00

# Solid Surface - Sink & Trim Bits with Insert Knives



## 880.56

Trim a sink cut-out flush with the bowl in stages using these “over-hang” and flush trim bits. The DELRIN® bearings are tapered to match the slope of the bowl’s side. A first pass with the overhang bit **880.562.11** cleans the cut-out edge, leaving a slight over-hang on the underside of the counter. A second pass with the flush-trim bit **880.561.11** completes the operation. Knives made from super micrograin carbide and sharpened on both sides guarantee longer life!

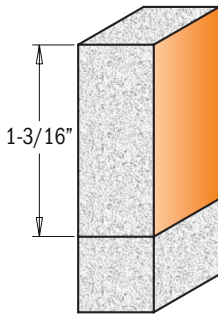

880.561.11

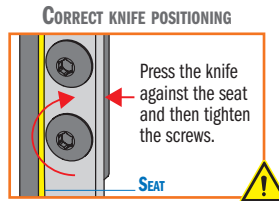

Drawing is 1:1 scale



**APPLICATION**  
 WILSONART®  
 GIBRALTAR®  
 CORIAN®  
 SURELL®  
 FOUNTAINHEAD®  
 AVONITE®  
 FORMICA®  
 Etc.

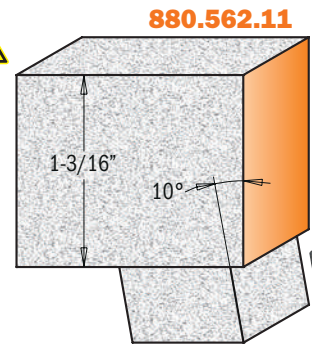

880.562.11

**SAFETY TIPS:** The **TW-006** Torque Screwdriver is recommended for the proper fastening of screws (see page 267).

ORDER NO.		D	I	A	L
S=01/2" shank		inches	mm	inches	inches
880.561.11	10	3/4	19.05	1-3/16	3-9/32
880.562.11	10	7/8	22	1-3/16	10°

Spare parts

790.300.03	990.075.00	991.061.00	791.046.00	990.058.00	991.057.00
790.300.03	990.075.00	991.061.00	791.048.00	990.058.00	991.057.00

# 13-piece Dovetail & Straight Router Bit Set



US PATENT NO. 7,703,605 AND OTHER FOREIGN PATENTS

CARBIDE TIPPED SOLID CARBIDE  
T2 RH



PACK QTY. 1 PC

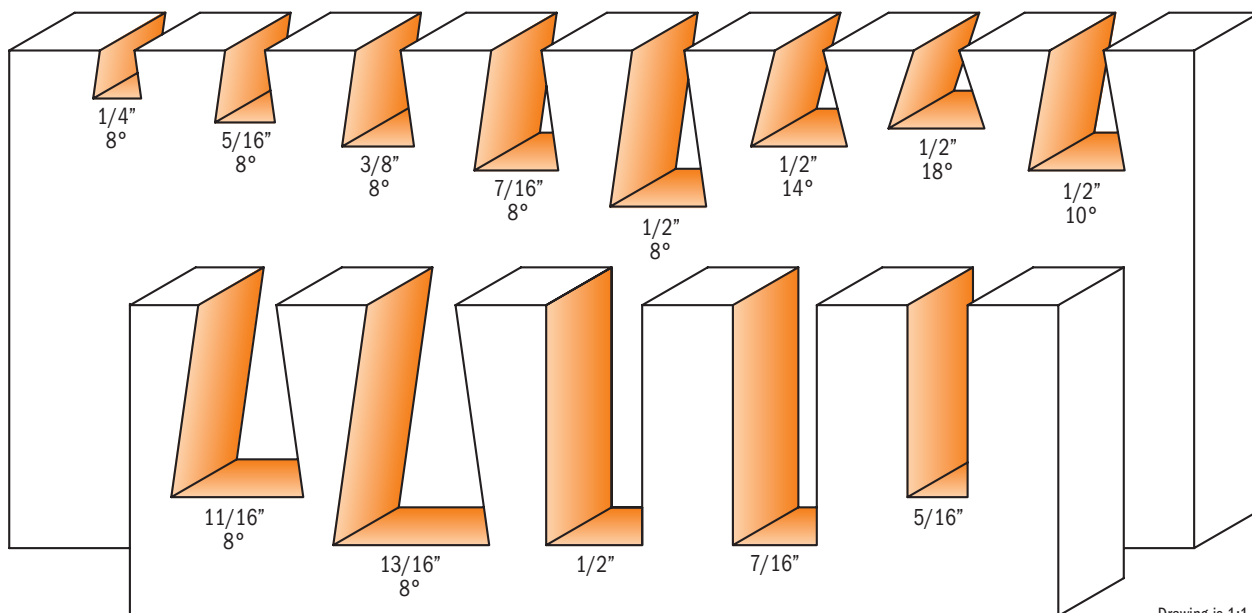

Drawing is 1:1 scale

IDEAL FOR LEIGH D4 JIG. Also suitable for many other jigs.

**800.519.11** 1/4" & 1/2" shank

SET CONTAINS	ORDER NO.	ORDER NO.	A	D		I		L		LEIGHT NO.
	S=Ø1/4" shank	S=Ø1/2" shank		inches	mm	inches	mm	inches	mm	
Dovetail Bit	<b>818.065.11</b>		8°	1/4	6.35	1/4	6.35	2	50.8	50
Dovetail Bit	<b>818.081.11</b>		8°	5/16	7.94	3/8	9.52	2-1/8	53.9	60
Dovetail Bit	<b>818.097.11</b>		8°	3/8	9.52	1/2	12.7	2-3/8	60.3	70
Dovetail Bit	<b>818.111.11</b>		8°	7/16	11.1	5/8	15.87	2-3/8	60.3	75
Dovetail Bit	<b>818.129.11</b>		8°	1/2	12.7	13/16	20.6	2-3/4	70	80
Dovetail Bit	<b>818.130.11</b>		14°	1/2	12.7	1/2	12.7	2-7/16	61.9	120
Dovetail Bit	<b>818.132.11</b>		18°	1/2	12.7	13/32	20.6	2-3/8	60.3	128
Dovetail Bit	<b>818.133.11</b>		10°	1/2	12.7	5/8	15.87	2-3/8	60.3	101
Dovetail Bit		<b>818.674.11</b>	8°	11/16	17.4	1	25.4	3-1/16	77.7	90
Dovetail Bit		<b>818.706.11</b>	8°	13/16	20.6	1-1/4	31.7	3-5/16	84.1	100
Straight Bit		<b>811.628.11</b>		1/2	12.7	1-1/4	31.7	3-1/4	82.5	160
Straight Bit		<b>812.611.11</b>		7/16	11.1	1-1/4	31.7	3-1/4	82.5	150
Straight Bit	<b>811.081.11</b>			5/16	7.94	1	25.4	2-3/4	70	140



# 15-piece Router Bit Sets

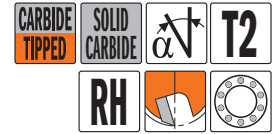

PACK QTY. 1 PC

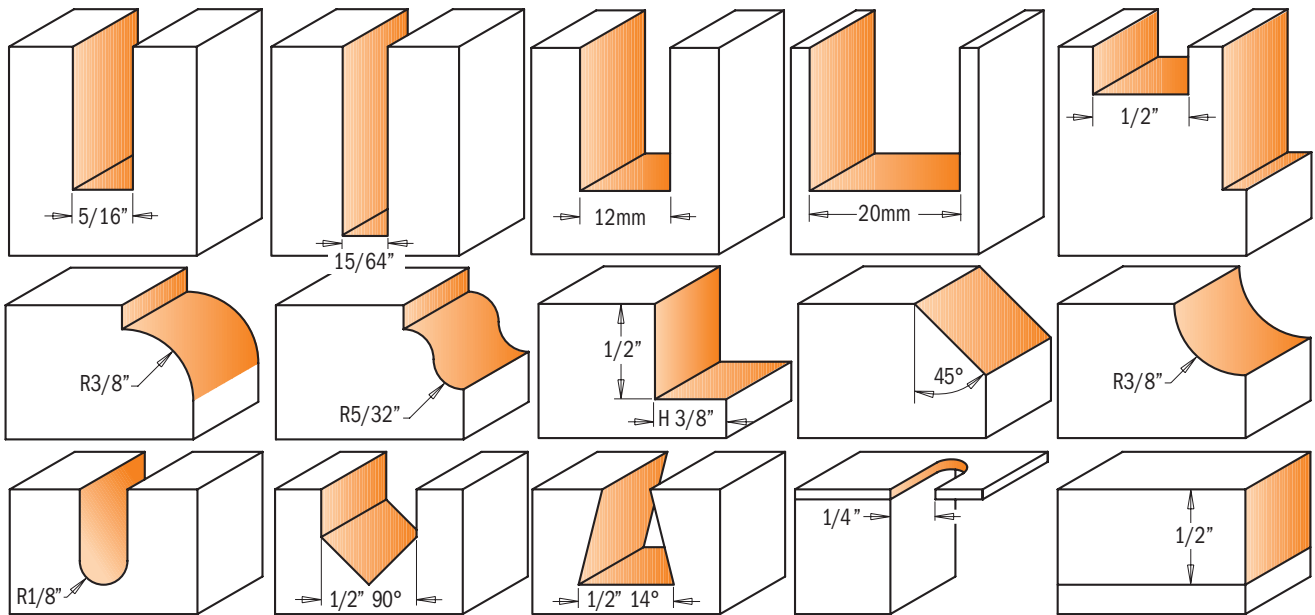

Drawing is 1:1 scale

## 800.001.00 1/4" shank

SET CONTAINS	ORDER NO. S=Ø1/4" shank	D		I		R		L		H		A
		inches	mm	inches	mm	inches	mm	inches	mm	inches	mm	
Straight Bit	<b>811.080.11</b>	5/16	7.94	3/4	19.05			2	50.8			
Straight Bit	<b>812.060.11</b>	15/64	6	1	25.4			2-3/8	60.3			
Straight Bit	<b>811.120.11</b>		12	3/4	19.05			2	50.8			
Straight Bit	<b>811.200.11</b>		20	3/4	19.05			2	50.8			
Mortising Bit	<b>801.127.11</b>	1/2	12.7	3/4	19.05			2-1/8	53.9			
Roundover Bit	<b>838.317.11</b>	1-1/4	31.7	9/16	14	3/8	9.52	2-1/4	57.1			
Ogee Bit	<b>840.270.11</b>	1-1/8	28.7	29/64	11.5	5/32	4					
Rabbeting Bit	<b>835.317.11</b>	1-1/4	31.7	1/2	12.7			2-5/16	58.7	3/8	9.52	
Chamfer Bit	<b>836.280.11</b>	1-1/4	31.7	3/8	9.52			2-3/32	53.1			45°
Cove Bit	<b>837.286.11</b>	1-1/4	31.7	1/2	12.7	3/8	9.52	2-1/8	53.9			
Round Nose Bit	<b>814.064.11</b>	1/4	6.35	1/2	12.7	1/8	3.17	2	50.8			
V-Groove Bit 90°	<b>815.127.11</b>	1/2	12.7	1/2	12.7			1-49/64	44.8			90°
Dovetail Bit	<b>818.128.11</b>	1/2	12.7	1/2	12.7			2-1/16	52.3			14°
Panel Pilot Bit	<b>816.064.11</b>	1/4	6.35	3/4	19.05			2-1/2	63.5			
Flush Trim Bit	<b>806.128.11</b>	1/2	12.7	1/2	12.7			2-9/32	57.9			



# 12-piece Router Bit Set

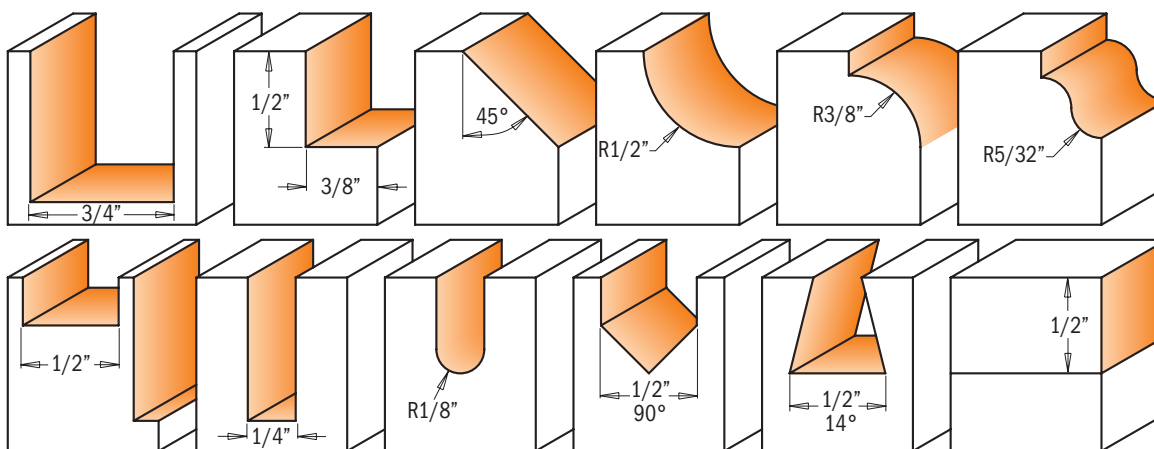

Drawing is 1:1 scale

## 800.503.11 1/4" shank

SET CONTAINS	ORDER NO. S=Ø1/4" shank	D		I		R		L		H		A
		inches	mm	inches	mm	inches	mm	inches	mm	inches	mm	
Flush Trim Bit	<b>806.128.11</b>	1/2	12.7	1/2	12.7			2-9/32	54.9			
Cove Bit	<b>837.350.11</b>	1-1/2	38.1	5/8	15.5	1/2	12.7	2-9/32	54.9			
Rabbeting Bit	<b>835.317.11</b>	1-1/4	31.7	1/2	12.7			2-5/16	58.7	3/8	9.52	
Roundover Bit	<b>838.317.11</b>	1-1/4	31.7	9/16	14	3/8	9.52	2-1/4	57.1			
Chamfer Bit	<b>836.420.11</b>	1-3/4	44.5	5/8	15.5			2-3/8	60.3			45°
Ogee Bit	<b>840.270.11</b>	1-1/8	28.7	29/64	11.5	5/32	4					
Straight Bit	<b>811.065.11</b>	1/4	6.35	3/4	19.05			2-1/4	57.1			
Straight Bit	<b>811.191.11</b>	3/4	19.05	3/4	19.05			2-1/4	57.1			
Mortising Bit	<b>801.127.11</b>	1/2	12.7	3/4	19.05			2-1/8	53.9			
Round Nose Bit	<b>814.064.11</b>	1/4	6.35	1/2	12.7	1/8	3.17	2	50.8			
V-Groove Bit	<b>815.127.11</b>	1/2	12.7	1/2	12.7			1-49/64	44.8			90°
Dovetail Bit	<b>818.128.11</b>	1/2	12.7	1/2	12.7			2-1/16	52.3			14°

# 13-piece Router Bit Set

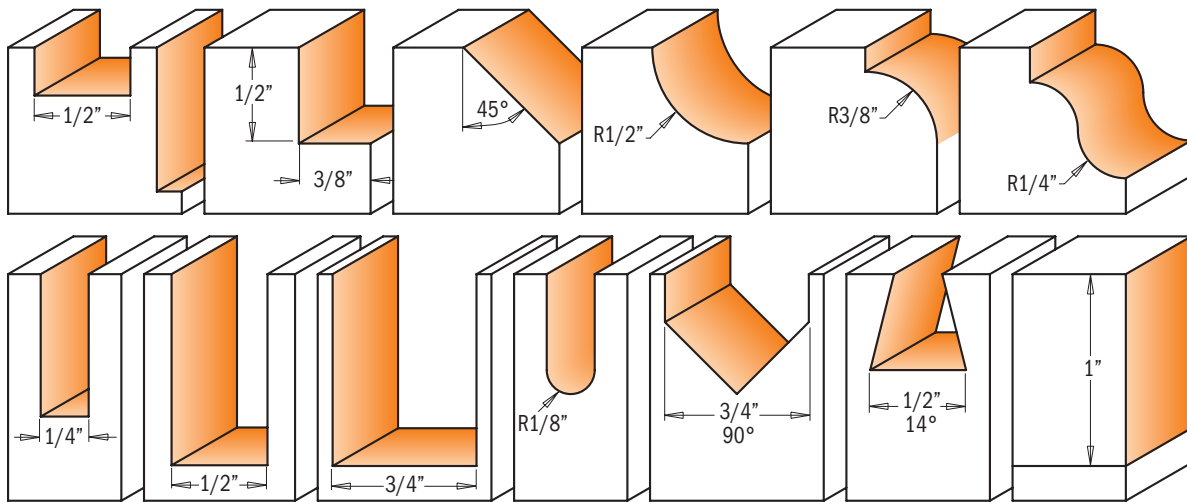

Drawing is 1:1 scale

## 800.505.11 1/2" shank

SET CONTAINS	ORDER NO. S=Ø1/2" shank	D		I		R		L		H		A
		inches	mm	inches	mm	inches	mm	inches	mm	inches	mm	
Straight Bit	<b>811.564.11</b>	1/4	6.35	3/4	19			2-3/8	60.3			
Straight Bit	<b>811.628.11</b>	1/2	12.7	1	25.4			3-1/4	82.5			
Flush Trim Bit	<b>806.627.11</b>	1/2	12.7	1	25.4			3-13/32	86.5			
Straight Bit	<b>811.690.11</b>	3/4	19.05	1	25.4			2-1/2	63.5			
Mortising Bit	<b>801.627.11</b>	1/2	12.7	3/4	19			2-3/8	60.3			
Roundnose Bit	<b>814.564.11</b>	1/4	6.35	5/8	15.87	1/8	3.17	2-1/2	63.5			
V-Groove Bit	<b>815.690.11</b>	3/4	19	5/8	15.87			2-1/2	63.5			90°
Dovetail Bit	<b>818.628.11</b>	1/2	12.7	1/2	12.7			2-1/2	63.5			14°
Cove Bit	<b>837.850.11</b>	1-1/2	38.1	5/8	15.87	1/2	12.7	2-17/32	64.2			
Rabbeting Bit	<b>835.817.11</b>	1-1/4	31.7	1/2	12.7			2-13/32	61.1	3/8	9.52	
Roundover Bit	<b>838.817.11</b>	1-1/4	31.7	9/16	14.2	3/8	9.52	2-7/16	61.9			
Ogee Bit	<b>840.850.11</b>	1-1/2	38.1	11/16	17.4	1/4	6.35					
Chamfer Bit	<b>836.920.11</b>	1-3/4	44.5	23/32	18.2			2-5/8	66.6			45°

# 6-piece Router Bit Set



PACK QTY.  
1 PC

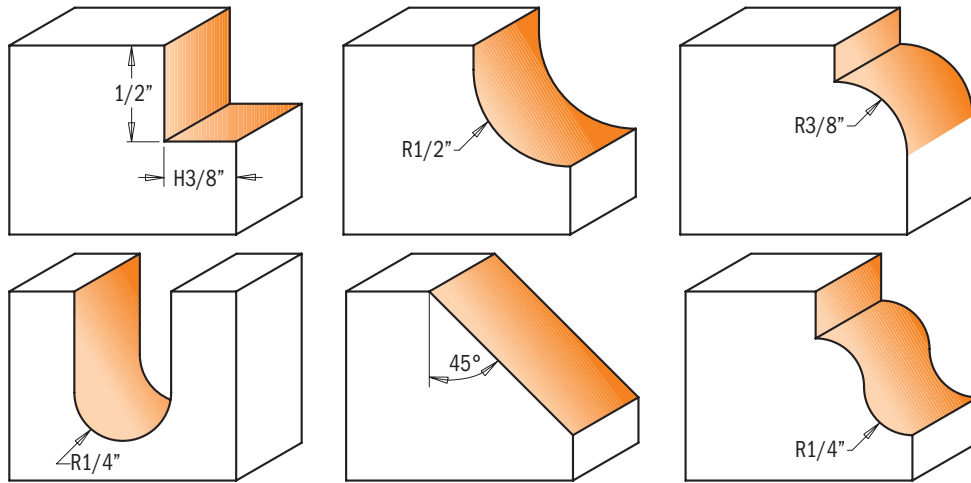

Drawing is 1:1 scale

## 800.504.11 1/2" shank

SET CONTAINS	ORDER NO. S=Ø1/2" shank	D		I		R		L		H		A
		inches	mm	inches	mm	inches	mm	inches	mm	inches	mm	
Rabbeting Bit	<b>835.817.11</b>	1-1/4	31.7	1/2	12.7			2-13/32	61.1	3/8	9.52	
Cove Bit	<b>837.850.11</b>	1-1/2	38.1	5/8	15.87	1/2	12.7	2-17/32	64.2			
Roundover Bit	<b>838.817.11</b>	1-1/4	31.7	9/16	14.2	3/8	9.52	2-7/16	61.9			
Roundnose Bit	<b>814.627.11</b>	1/2	12.7	1-1/4	31.7	1/4	6.35	2-7/8	73			
Chamfer Bit	<b>836.920.11</b>	1-3/4	44.5	23/32	18.2			2-5/8	66.6			45°
Ogee Bit	<b>840.850.11</b>	1-1/2	38.1	11/16	17.4	1/4	6.35					



# 5-piece Complete Kitchen Sets

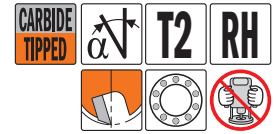

PACK QTY.  
1 PC

## 800.509.11 1/2" shank

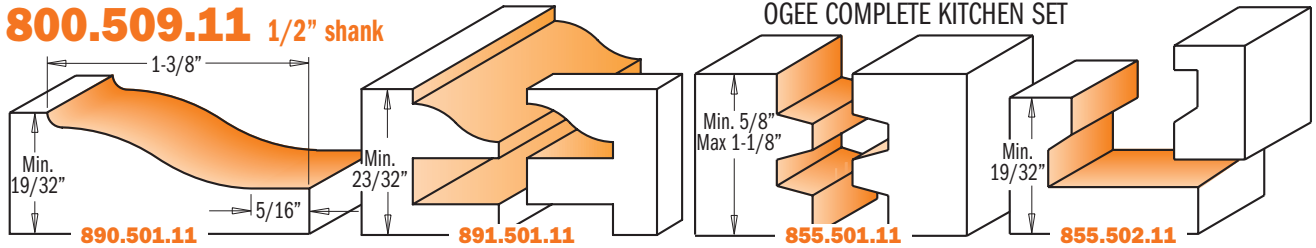

Drawing is 1:1 scale

SET CONTAINS	ORDER NO.	D		I		T <sub>1</sub>	L		LB
	S=Ø1/2" shank	inches	mm	inches	mm	inches	inches	mm	inches
Ogee Raised Panel Bit	890.501.11	3-1/4	82.5	19/32	15	19/32 to 23/32	2-1/2	63.8	1/2
Ogee Rail & Stile Bits	891.501.11	1-3/4	44.5			23/32 to 7/8	2-51/64	71	22mm
Reverse Glue Joint Bit	855.501.11	1-3/4	44.5	1-1/4	31.7	19/32 to 1-3/16	2-3/4	70.1	
Drawer Lock Bit	855.502.11	2	50.8	1/2	12.7	5/8 to 1	2	50.8	

## 800.510.11 1/2" shank

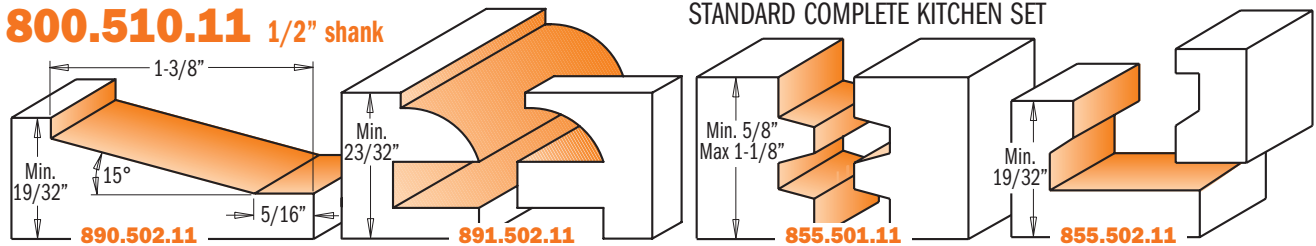

SET CONTAINS	ORDER NO.	D		I		T <sub>1</sub>	L		LB
	S=Ø1/2" shank	inches	mm	inches	mm	inches	inches	mm	inches
Standard Raised Panel Bit	890.502.11	3-1/4	82.5	19/32	15	19/32 to 23/32	2-1/2	63.8	1/2
Standard Rail & Stile Bits	891.502.11	1-3/4	44.5			23/32 to 7/8	2-51/64	71	22mm
Reverse Glue Joint Bit	855.501.11	1-3/4	44.5	1-1/4	31.7	19/32 to 1-3/16	2-3/4	70.1	
Drawer Lock Bit	855.502.11	2	50.8	1/2	12.7	5/8 to 1	2	50.8	

## 800.511.11 1/2" shank

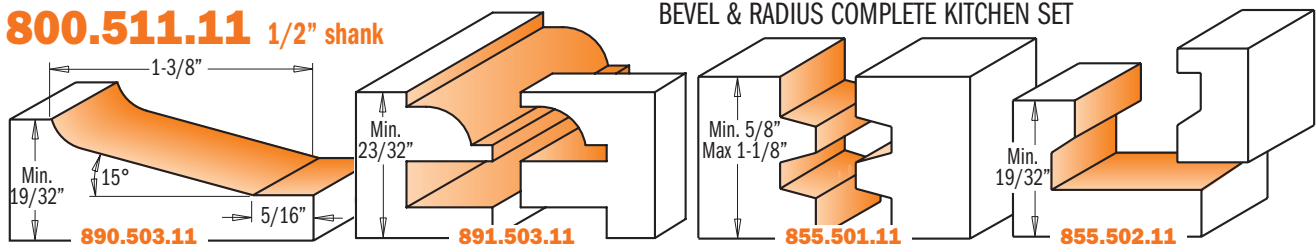

SET CONTAINS	ORDER NO.	D		I		T <sub>1</sub>	L		LB
	S=Ø1/2" shank	inches	mm	inches	mm	inches	inches	mm	inches
Bevel & Radius Raised Panel Bit	890.503.11	3-1/4	82.5	19/32	15	19/32 to 23/32	2-17/32	64.6	1/2
Bevel & Radius Rail & Stile Bits	891.503.11	1-3/4	44.5			23/32 to 7/8	2-51/64	71	22mm
Reverse Glue joint Bit	855.501.11	1-3/4	44.5	1-1/4	31.7	19/32 to 1-3/16	2-3/4	70.1	
Drawer Lock Bit	855.502.11	2	50.8	1/2	12.7	5/8 to 1	2	50.8	



# 3-piece Kitchen Sets

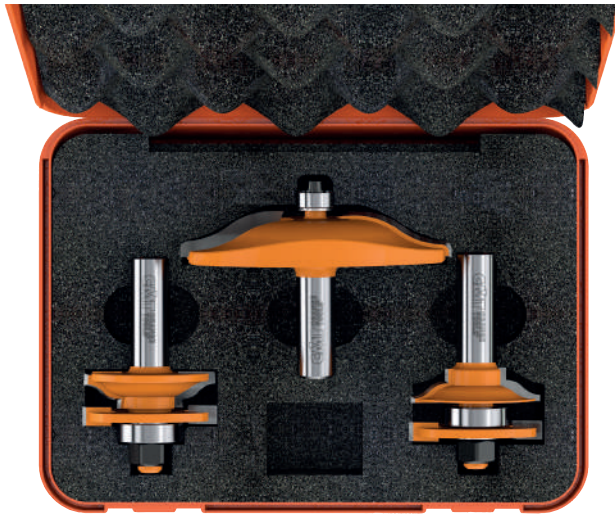

## 800.513.11

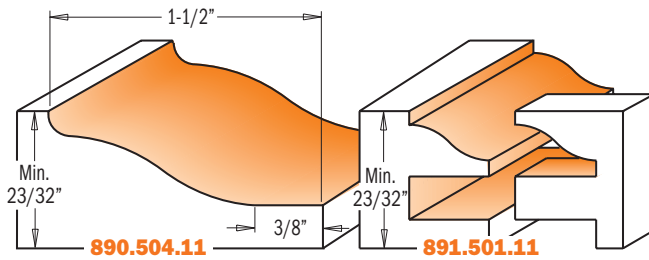

## 800.512.11

Drawing is 1:1 scale

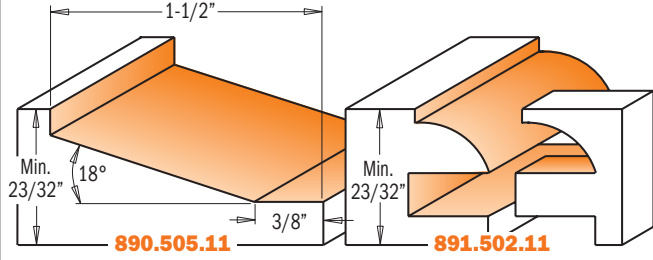

## 800.514.11

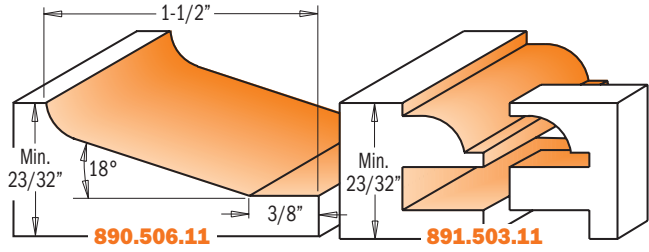

## 800.516.11

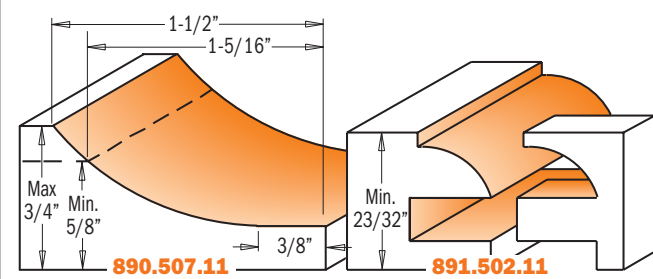

## 800.513.11 Ogee Kitchen Set 1/2" shank

SET CONTAINS	ORDER NO. S=Ø1/2" shank	D		I		T <sub>1</sub>	L		LB
		inches	mm	inches	mm	inches	inches	mm	inches
Ogee Raised Panel Bit	890.504.11	3-1/2	88.9	19/32	15	23/32 to 25/32	2-17/32	64.6	1/2
Ogee Rail & Stile Bits	891.501.11	1-3/4	44.5			23/32 to 7/8	2-51/64	71	22mm

## 800.512.11 Standard Kitchen Set 1/2" shank

Standard Raised Panel Bit	890.505.11	3-1/2	88.9	19/32	15	23/32 to 25/32	2-17/32	64.6	1/2
Standard Rail & Stile Bits	891.502.11	1-3/4	44.5			23/32 to 7/8	2-51/64	71	22mm

## 800.514.11 Bevel & Radius Kitchen Set 1/2" shank

Bevel & Radius Raised Panel Bit	890.506.11	3-1/2	88.9	19/32	15	23/32 to 25/32	2-17/32	64.6	1/2
Bevel & Radius Rail & Stile Bits	891.503.11	1-3/4	44.5			23/32 to 7/8	2-51/64	71	22mm

## 800.516.11 Cove Kitchen Set 1/2" shank

Cove Raised Panel Bit	890.507.11	3-1/2	88.9	19/32	15	23/32 to 25/32	2-17/32	64.6	1/2
Standard Rail & Stile Bits	891.502.11	1-3/4	44.5			23/32 to 7/8	2-51/64	71	22mm

# 6-piece Cabinetmaking Sets

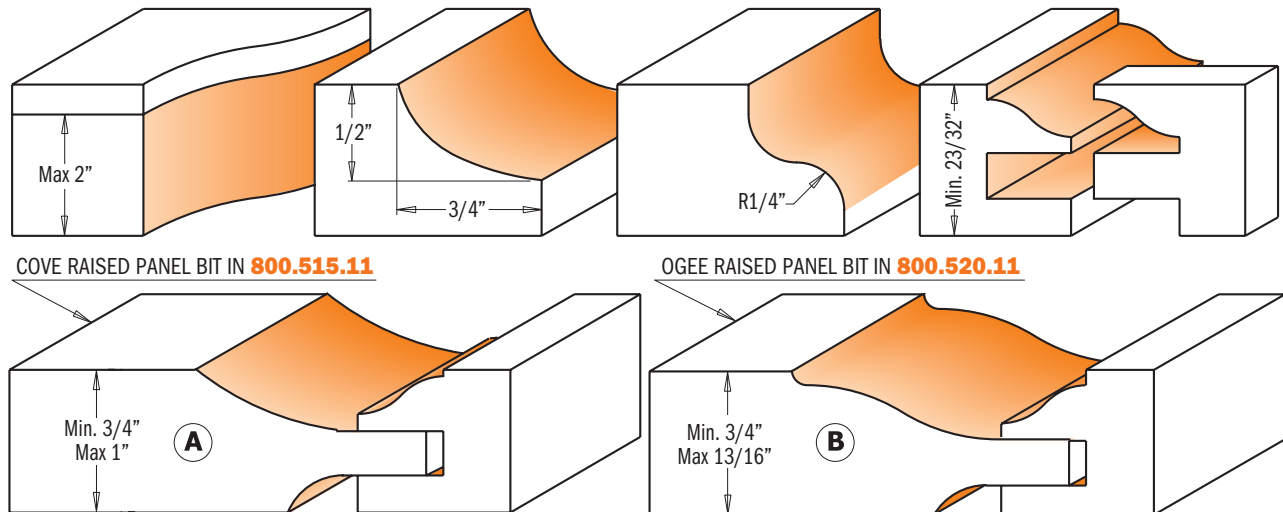
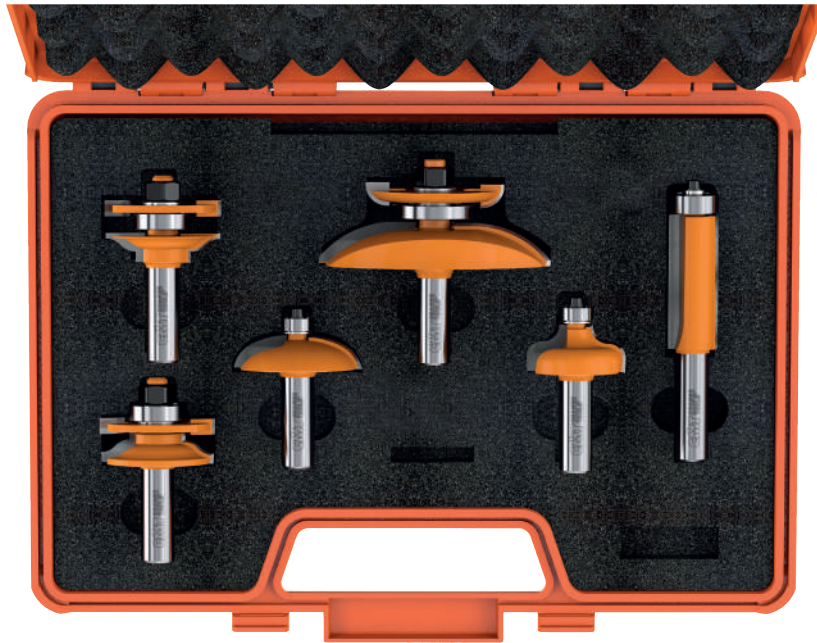

Drawing is 1:1 scale

## 800.515.11 COVE CABINETMAKING SET 1/2" shank

SET CONTAINS	ORDER NO. S=Ø1/2" shank	D		I		R		L inches	LB inches
		inches	mm	inches	mm	inches	mm		
Cove Raised Panel w/Back Cutter	890.527.11	3-1/2	89	1-1/8	28.5	1-1/2	38.1	3-35/64	1-1/4 & 16mm
Ogee Rail & Stile Bits	891.501.11	1-3/4	44.5	7/8	22.2	5/16	7.94	2-51/64	7/8
Super Duty Flush Trim Bit	806.690.11	3/4	19.05	2	50.8			4-5/16	3/4
Drawer Front Bit	837.955.11	2	50.8	1/2	12.7			2-13/32	1/2
Ogee Door Edge Bit	859.564.11	1-1/2	38.1	3/4	19.05	1/4	6.35	2-5/8	1/2

## 800.520.11 OEGEE CABINETMAKING SET 1/2" shank

SET CONTAINS	ORDER NO. S=Ø1/2" shank	D		I		R		L inches	LB inches
		inches	mm	inches	mm	inches	mm		
Ogee Raised Panel w/Back Cutter	890.524.11	3-1/2	89	1-1/8	28.5	15/16	23.8	3-5/64	1-1/4 & 16mm
Ogee Rail & Stile Bits	891.501.11	1-3/4	44.5	7/8	22.2	5/16	7.94	2-51/64	7/8
Super Duty Flush Trim Bit	806.690.11	3/4	19.05	2	50.8			4-5/16	3/4
Drawer Front Bit	837.955.11	2	50.8	1/2	12.7			2-13/32	1/2
Ogee Door Edge Bit	859.564.11	1-1/2	38.1	3/4	19.05	1/4	6.35	2-5/8	1/2

# Building Arched Raised Panel Doors

## STEP 1. MAKING A SAMPLE DOOR

- A) This sample door size is 12" wide by 20" long.
- B) The door thickness should be 3/4" - 7/8"

## STEP 2. DETERMINING THE SIZES OF EACH PART OF THE DOOR

- A) Always use a 1/2" overlay on all sides of the door.
- B) If the door opening is 11" wide by 19" high then the door size is 12" x 20".

**IMPORTANT:** Use 2-7/16" wide stiles so the templates will work properly.

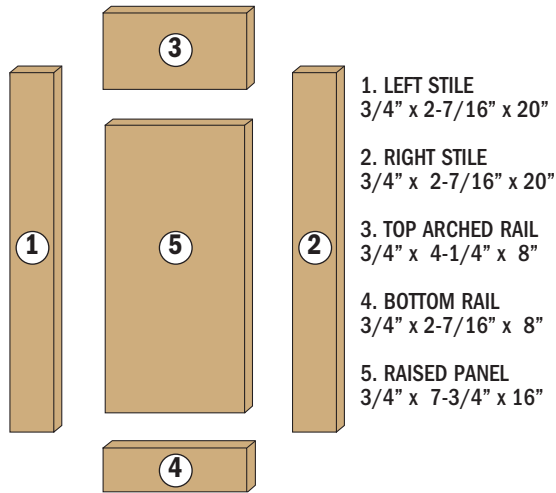

### 1-2. LEFT AND RIGHT STILES

- A) Always cut stiles 2-7/16" wide.
- B) Length of stiles is same as door length.

### 3. TOP ARCHED RAIL

- A) Cut 4-1/4" wide. Templates are 4" wide.
- B) Length of rail is found by subtracting 4" from the total door width. (Overall door width is 12" minus 4" = 8" length of rail)

**NOTE:** THIS FOLLOWING PROCEDURE CAN ONLY BE USED WHEN USING 2-7/16" WIDE STILES. SUBTRACT 4" FROM THE TOTAL DOOR WIDTH INSTEAD OF 4-7/8" SINCE 7/16" IN EACH STILE WILL BE TAKEN UP IN THE PATTERN CUT.

### 4. BOTTOM RAIL

- A) Always cut 2-7/16" wide.
- B) Length of rail is again found by subtracting 4" from the total door width. (Overall door width is 12" minus 4" = 8" for bottom rail lengths)

### 5. RAISED PANEL

- A) Width is always 1/4" less than rail length. (1/8" space should be left on each side for expansion of panel)
- B) Rail length is 8" minus 1/4" = 7-3/4" width of raised panel.
- C) Length of raised panel is found by taking the overall door length and again subtracting 4". (Overall door length is 20" minus 4" = 16" length of panel)

SUBTRACT 4" FROM THE OVERALL LENGTH OF THE DOOR. SUBTRACT 4" INSTEAD OF 4-7/8" SINCE THE PATTERN CUT TAKES UP 7/16" ON EACH RAIL.

At this point, all 5 pieces of the door should be cut to the correct size.

## STEP 3. CUTTING THE COPE CUTS ON EACH END OF THE 2 RAILS

- A) Cope cutter is the cutter with the bearing in the middle
- B) Set the cope cutter to the correct height in the router.

- 1) The correct height is when, after the cut is made, the reveal on the front side should be 1/8" minimum (Illustration 1)

- 2) Spaces A and B shown should be equal. If one is to be bigger, make B thicker for strength of panel.

- C) Set fence even with bearing.

- D) Use wooden pushblock to prevent tearout at end of cope cut.

- E) Run stock through with good side down at 14,000-16,000 RPMs.

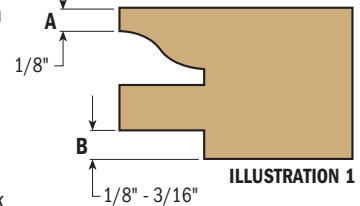

## STEP 4. USING RAIL TEMPLATE TO FLUSH TRIM TOP RAIL TO CORRECT SHAPE

- A) Locate center of top rail with pencil on the back side.
- B) Pick out the correct template.

**NOTE:** THE SIZE ON THE TEMPLATE IS FOR THE OVERALL DOOR WIDTH. FOR THE TEMPLATES TO WORK PROPERLY STILES MUST BE MADE 2-7/16" WIDE. IF STILES ARE MADE IN DIFFERENT WIDTHS, ADJUSTMENTS IN PICKING OUT TEMPLATES MUST BE MADE.

- C) Line up template on back side of rail centering the notch of template with center line of rail. Now nail through the template into the 2 copes that were just cut (Illustration 2).

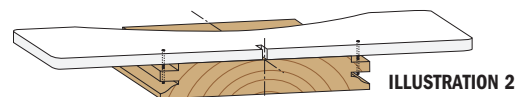

- D) Rough cut with jig or band saw within 1/8" or 1/4" of template (Illustration 3).

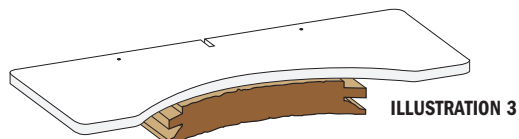

- E) Put flush trimming bit into router and set so bearing is flush with template (Illustration 4).

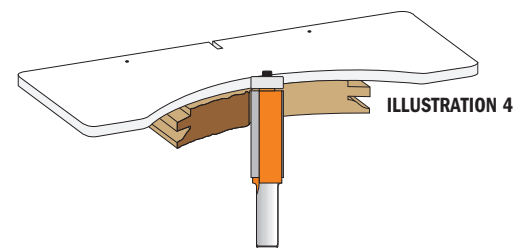

- F) Run router at 20,000-22,000 RPMs and flush trim top crown rail with good side down.

# Building Arched Raised Panel Doors

**NOTE:** WHEN STARTING CUT, ALWAYS REMEMBER TO MAKE CONTACT WITH BEARING TO A PLACE ON THE TEMPLATE WHERE THERE IS NO WOOD TO PREVENT KICKBACK.

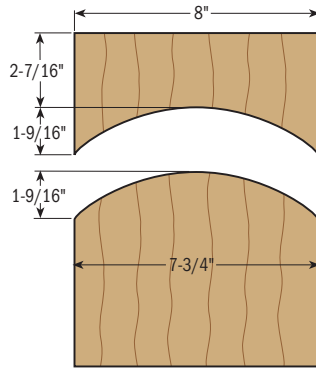

**G)** Slow down at end of cut to prevent tearout. Leave template attached to rail for now.

## STEP 5. USING PANEL TEMPLATE TO FLUSH TRIM THE RAISED PANEL TO SHAPE

- A)** Locate center of raised panel on front side.
- B)** Pick out correct template (same size as rail template).
- C)** Line up center notch of template with center line of panel and make sure it is also square (Illustration 5).
- D)** Nail template to panel about 1/2" in from each side (Illustration 5).

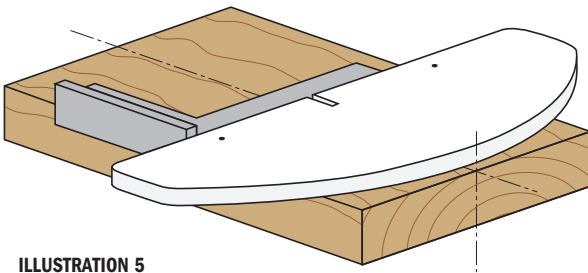

ILLUSTRATION 5

**NOTE:** DRIVE NAILS IN ABOUT 1/4"-3/8". THE NAIL HOLES WILL BE MACHINED OUT WHEN RAISED PANEL CUT IS MADE.

- E)** Rough cut stock to within 1/8" - 1/4" of template.
- F)** Flush trim raised panel in the same manner as you did the top rail with the template on top (Back to illustration 4).

**NOTE:** AGAIN MAKE SURE BEARING COMES IN CONTACT WITH TEMPLATE FIRST AND THEN GUIDE INTO THE WOOD.

**G)** Pull nails out after flush trimmed.

## STEP 6. CUTTING FREEHAND PATTERN CUT ON TOP ARCHED RAIL

- A)** Pattern cutter is the cutter with the bearing on top.
- B)** Insert pattern cutting bit to correct height to match cope cut. This can be done by making a few practice cuts in scrap wood.
- C)** Run router at 14,000-16,000 RPMs.
- D)** Start cut with bearing making contact with template only and ease into cut. No fence is used. (Illustration 6).
- E)** Slow down at end of cut to prevent any chipout.
- F)** Remove template from top arched rail.

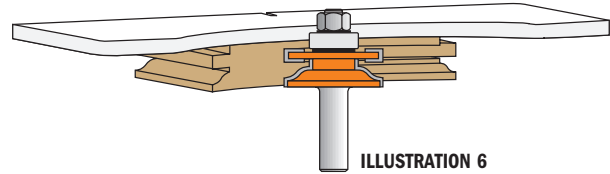

ILLUSTRATION 6

## STEP 7. CUTTING THE STRAIGHT BOTTOM RAIL AND 2 STILES

- A)** Insert fence and line up fence with bearing on the same pattern cutter.
- B)** Run router 14,000-16,000 RPMs
- C)** Use push-block and push bottom rail and stiles through with good side down.

## STEP 8. MAKING RAISED PANEL CUT

**A)** Insert panel cutter to correct height.

**NOTE:** IT MAY TAKE A COUPLE OF PRACTICE CUTS IN SCRAP WOOD BEFORE GETTING THE PANEL FLUSH WITH PATTERN CUT.

- B)** Set fence so it is even with bearing on panel cutter.
- C)** Run router slow 10,000 RPMs. ALWAYS USE PUSH BLOCKS FOR SAFETY.
- D)** Make first cut across the grain with good side face down.
- E)** Cut with the grain on left side.
- F)** Remove fence and use a half-fence. (Illustration 7)
- G)** Start by re-doing left side and come around and cut the curved top of the panel freehand.
- H)** Install full fence and complete right side.

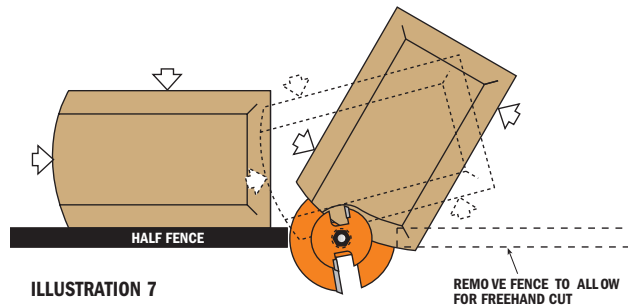

ILLUSTRATION 7

REMOVE FENCE TO ALLOW FOR FREEHAND CUT



# 3-piece Junior Raised Panel Sets with Back Cutter



CMT's Junior Raised Panel Sets add intricate detail on a whole new scale! The Junior Raised Panel Set lets you make frame and panel details as small as 2-3/4" square in material as thin as 7/16". Delicate panel doors are only the beginning - use these bits with templates to add interesting arches to your work. The set includes your choice of a Cove or Ogee Raised Panel Bit and an Ogee Rail & Stile pair. Packaged in a handy lightweight recloseable plastic case.

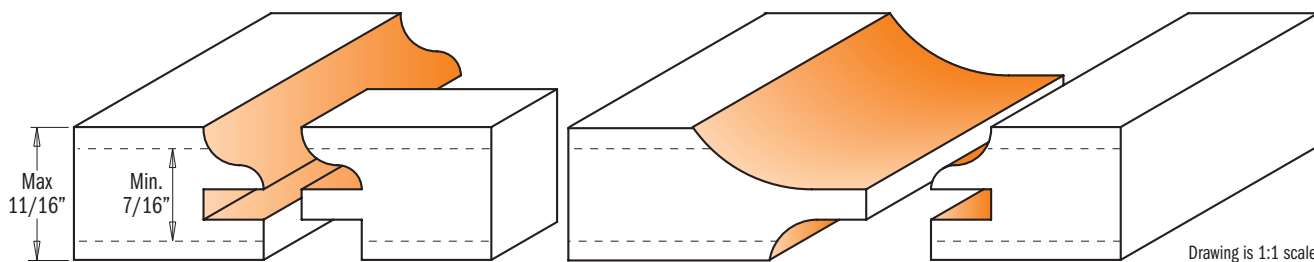

Drawing is 1:1 scale

## 800.518.11 COVE JUNIOR RAISED PANEL SET 1/2" shank

SET CONTAINS	ORDER NO.	D		I		R		L	LB
	S=Ø1/2" shank	inches	mm	inches	mm	inches	mm	inches	inches
Cove Junior Raised Panel w/Back Cutter	<b>890.537.11</b>	2-1/2	63.5	11/16	17.4	3/4	19.05	2-3/4	5/8
Ogee Junior Rail & Stile Bits	<b>891.517.11</b>	1-1/4	31.7	11/16	17.4	1/8-3/16	3.2-4.7	2-41/64	5/8

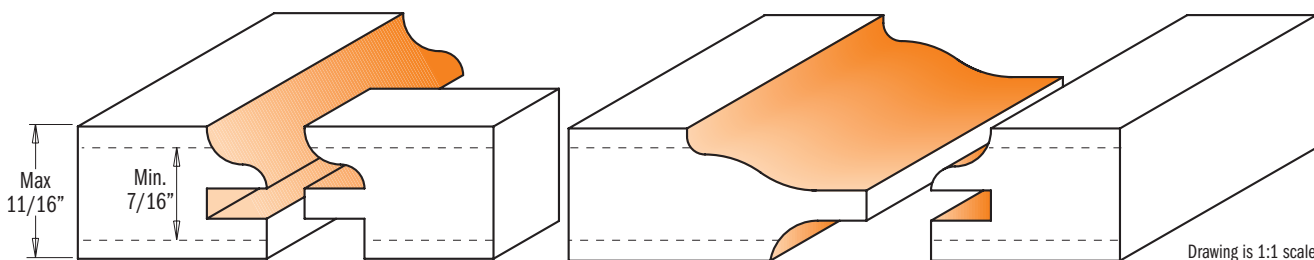

Drawing is 1:1 scale

## 800.522.11 OEGEE JUNIOR RAISED PANEL SET 1/2" shank

SET CONTAINS	ORDER NO.	D		I		R		L	LB
	S=Ø1/2" shank	inches	mm	inches	mm	inches	mm	inches	inches
Ogee Junior Raised Panel w/Back Cutter	<b>890.534.11</b>	2-1/2	63.5	11/16	17.4	1/2	12.7	2-3/4	5/8
Ogee Junior Rail & Stile Bits	<b>891.517.11</b>	1-1/4	31.7	11/16	17.4	1/8-3/16	3.2-4.7	2-41/64	5/8

# 3-piece Raised Panel Sets with Back Cutter



If your project calls for top quality raised panel doors, milled with accuracy and efficiency, then this set is a great choice. The ogee rail and stile bits are made to exact specifications to match perfectly, and the stile cutter is designed with a shear angle to produce superior cuts with minimal splintering. The raised panel bit is available with either cove or ogee profiles. Both bits include a back cutter which allows milling of the front and back of the panel in a single pass. Packaged in a sturdy recloseable plastic case.

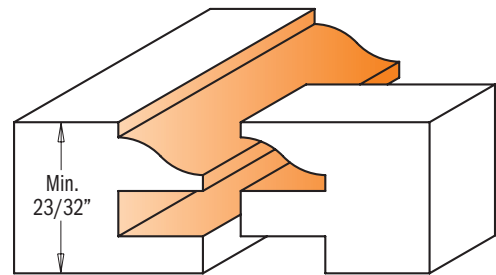
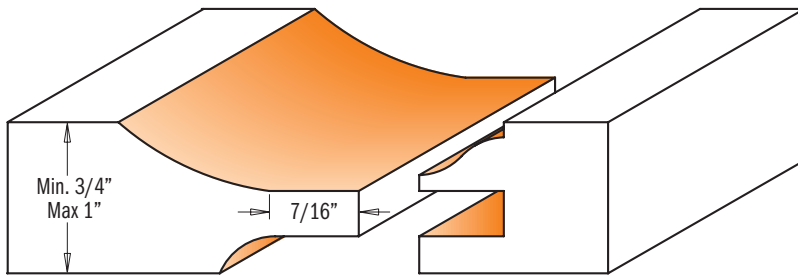

Drawing is 1:1 scale

## 800.517.11 COVE RAISED PANEL SET 1/2" shank

SET CONTAINS	ORDER NO.	D		I		R		L	LB
	S=01/2" shank	inches	mm	inches	mm	inches	mm	inches	inches
Cove Raised Panel w/Back Cutter	<b>890.527.11</b>	3-1/2	89	1-1/8	28.5	1-1/2	38.1	3-5/64	1-1/4 & 16mm
Ogee Rail & Stile Bits	<b>891.501.11</b>	1-3/4	44.5	7/8	22.2	5/16	7.94	2-51/64	7/8

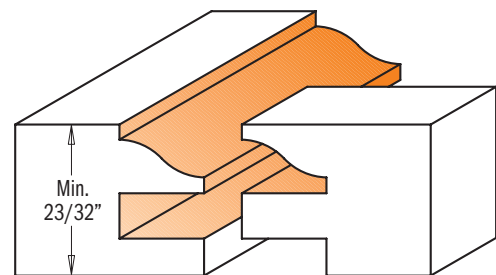
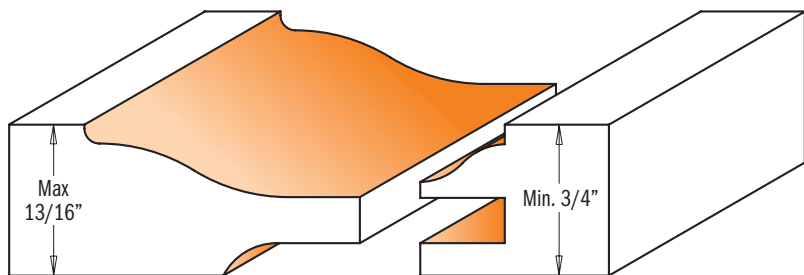

Drawing is 1:1 scale

## 800.521.11 OEGE RAISED PANEL SET 1/2" shank

SET CONTAINS	ORDER NO.	D		I		R		L	LB
	S=01/2" shank	inches	mm	inches	mm	inches	mm	inches	inches
Ogee Raised Panel w/Back Cutter	<b>890.524.11</b>	3-1/2	89	1-1/8	28.5	15/16	23.8	3-5/64	1-1/4 & 16mm
Ogee Rail & Stile Bits	<b>891.501.11</b>	1-3/4	44.5	7/8	22.2	5/16	7.94	2-51/64	7/8



# 3-piece Small Arch Door Set



This three-piece set will produce beautiful raised panel doors with a classic, diminutive beveled profile. Designed for use in fine furniture making, the set includes two matched cope and stick bits for producing frames in 5/8" to 3/4" thick material. The stick bit shapes a decorative 3/16" thumbnail molding along the edge of the frame. The panel bit is designed for 1/2" thick material. All bits are equipped with guide bearings for shaping curved work such as the small arched panel doors seen on secretaries and corner cabinetry. This set also produces panels for small chests, lids for small boxes, or drawer fronts. Instructions included. Packaged in a sturdy recloseable plastic case.

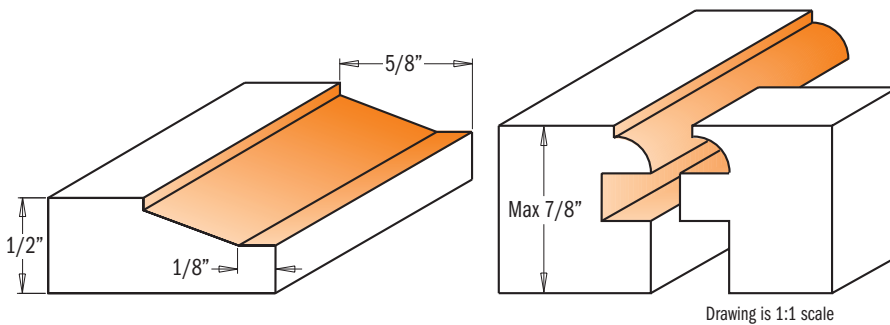

## 800.524.11 1/2" shank

SET CONTAINS	ORDER NO. S=Ø1/2" shank	D		I		T <sub>1</sub>	L		LB
		inches	mm	inches	mm	inches	inches	mm	inches
Small Standard Raised Panel Set	<b>890.512.11</b>	1-7/8	47.6	3/8	9.52	1/2 to 19/32	2-9/32	58	1/2
Small Standard Rail & Stile Bits	<b>891.512.11</b>	1-1/8	28.7			5/8 to 7/8	3-1/8	79.2	16mm

# Slot Cutter Set



Create slots, grooves and rabbets in all materials using the adjustable CMT slot cutter set. See chart below for all applications and correct cutter combinations. Ideal for biscuit joints and milling perfect tongue and groove joints.

The set includes 4 different bearings which allow cutting depth of 5/16" - 3/8" - 1/2" and 9/16". Packaged in a sturdy recloseable plastic case.

**SAFETY TIPS:** never use the slot cutter set without shims between the cutters. The distance between the cutters can vary from 3/64" to 1/16". A shim must also be positioned between the ball bearing and the cutters.

## ASSEMBLY ILLUSTRATION

Spare parts		ORDER NO.
H inches	mm	
9/16	8-19	791.034.00
1/2	8-22	791.005.00
3/8	8-28,5	791.030.00
5/16	8-31,5	791.033.00

## 823.001.11

SET CONTAINS	PIECES	ORDER NO.	S		I		D		B
			inches	mm	inches	mm	inches	mm	
Slot cutter	1	822.316.11							8
Slot cutter with 45° bore	1	823.332.11							8
Slot cutter with 45° bore	1	823.340.11							8
Slot cutter	1	822.348.11							8
Slot cutter with 45° bore	3	823.364.11							8
Slot cutter arbor with bearing Ø1/2" - 7/8"	1	824.121.10	1/2						
Slot cutter arbor with bearing Ø5/16" - 7/8"	1	824.122.10	1/2						
Slot cutter arbor with bearing Ø5/16" - 7/8"	1	824.127.10	1/2						
Slot cutter arbor with bearing Ø5/16" - 7/8"	1	824.128.10	1/2						
Bearing	1	791.033.00					1-1/4	31.7	8
Bearing	1	791.030.00					1-1/8	28.57	8
Bearing	1	791.034.00					3/4	19.05	8
Hex key 3mm	1	991.067.00							



## Adjustable Shaker Router Bit Sets



### 800.624

These new bit sets are excellent for producing adjustable tongue and groove joints with a bevel, in order to eliminate panel rattle that may occur with the production of standard cabinets. Cut precise grooves into your plywood veneered panels and make perfect rattle-free fits. To be used on table-mounted routers. Avoid using these bits in hand-held power tools.

Drawing is 1:1 scale

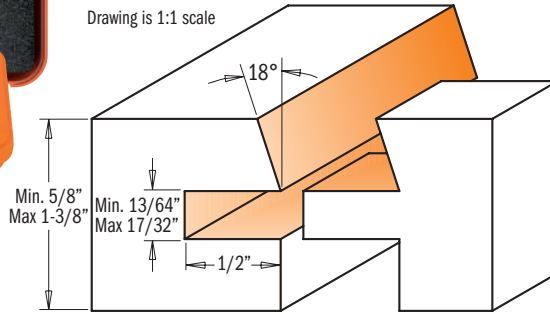

PACK QTY.  
5 PCS

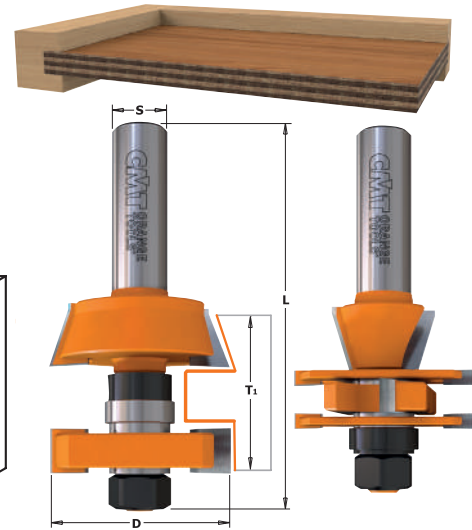

ORDER NO. S=Ø1/2" shank	D inches	mm	T <sub>1</sub> inches	A	L inches
<b>800.624.11</b>	1-5/8	41.2	5/8 - 1-3/8	18°	3-27/64

Spare parts

791.025.00	822.025.11	822.026.11	822.027.11	822.028.11	990.020.00	
	3.7mm	7.14mm	3.7mm	10.4mm		

Spare parts: **541.515.00** 0.1mm spacer  
**541.516.00** 0.3mm spacer

**541.517.00** 0.5mm spacer  
**541.518.00** 1mm spacer

**541.500.00** 3mm spacer  
**541.519.00** 5.8mm spacer

## Adjustable Tongue & Groove Bit Set for Mission Style Cabinet Doors



### 800.625

Exclusive CMT design which allows the perfect fit for undersized plywood panel. The tongue cutter features opposing shear angles to obtain flawless finishing on a large variety of materials such as plywood, softwood and hardwood.

For use on a table-mounted router. Not for handheld routers.

- Adjustable in 0.002" increments;
- For groove width from 13/64" to 17/32";
- Cut stock thickness of 1/2" to 1-1/4";
- Features micrograin carbide for longer life.

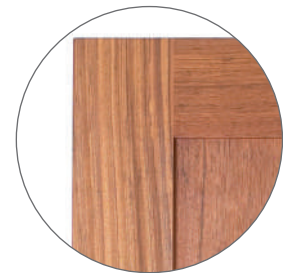

PACK QTY.  
5 PCS

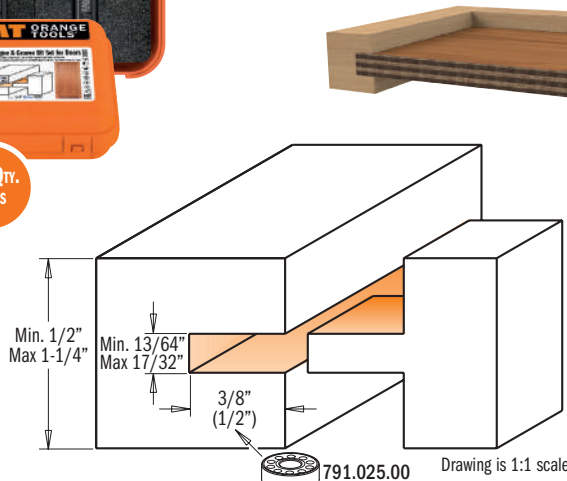

Drawing is 1:1 scale

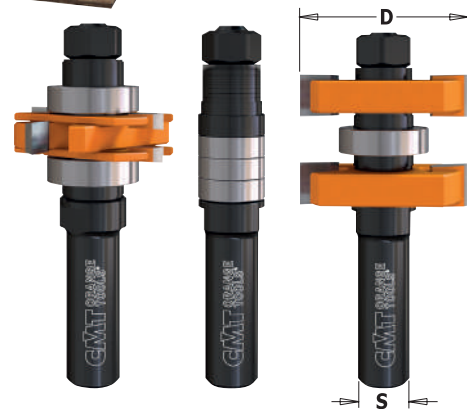

ORDER NO. S=Ø1/2" shank	D inches	mm	T <sub>1</sub> inches
<b>800.625.11</b>	1-5/8	41.2	1/2 - 1-1/4

Spare parts

824.136.00	791.012.00	822.025.11	822.026.11	822.027.11	822.028.11	990.020.00
	8-22mm	3.7mm	7.14mm	3.7mm	10.4mm	

Spare parts: **541.515.00** 0.1mm spacer  
**541.516.00** 0.3mm spacer

**541.517.00** 0.5mm spacer  
**541.518.00** 1mm spacer

**541.500.00** 3mm spacer  
**541.519.00** 5.8mm spacer

# Tenon Cutting Router Bits



**800.627**

CARBIDE TIPPED

T2

RH



**Cut perfectly fitted tenons, everytime.**

If you've struggled cutting tenons that fit, here's the perfect solution for precise tenons. CMT's new tenon cutting router bit will produce perfectly fitting tenons in every board you cut, even if the boards vary slightly in thickness. Simply set the distance between the cutters using the included spacers, and you can easily cut tenons from 3/16" to 5/8" thick, up to 1-1/16" long. This simple-to-use router bit takes the mystery out of achieving the excellent tenon-to-mortise fit required for high quality joinery.

**SAFETY PRECAUTIONS:**

maximum speed: 12,000 rpm.  
Router table only.

PACK QTY.  
5 PCS

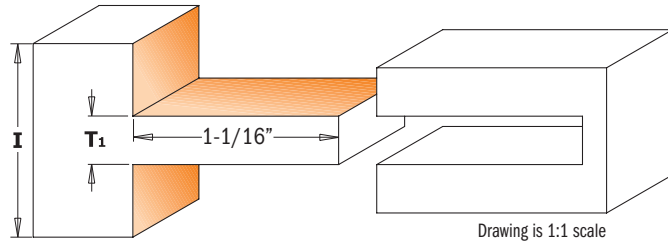

ORDER NO. S=Ø1/2" shank	I		D	T <sub>1</sub>	L
	inches	mm	inches	inches	inches
<b>800.627.11</b>	1-3/8	34.9	3	3/16 - 3/8	3-5/16

Spare parts

824.134.00	822.020.11	541.526.00	541.520.00	541.521.00	541.522.00	541.523.00

Spare parts: **990.022.00** Nut for arbor, M12x1.25mm

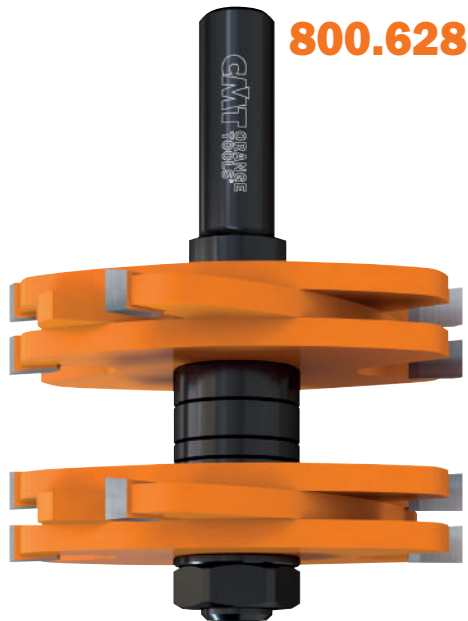

**800.628**

PACK QTY.  
5 PCS

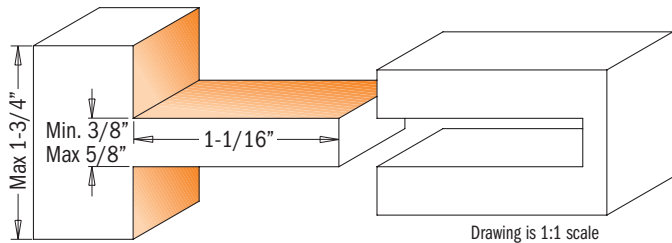

ORDER NO. S=Ø1/2" shank	I		D	T <sub>1</sub>	L
	inches	mm	inches	inches	inches
<b>800.628.11</b>	1-3/4	44.5	3	3/8 - 5/8	4

Spare parts

824.135.00	822.020.11	541.526.00	541.520.00	541.521.00	541.522.00	541.523.00

Spare parts: **990.022.00** Nut for arbor, M12x1.25mm

# 3-piece Tongue & Groove Cabinetmaking Set



PACK QTY.  
1 PC

CMT has developed a tongue and groove cabinet making system that derives from traditional European methods of joinery. Combine the CMT tongue and groove system with the ease and speed of new world pocket hole methods and you have the versatility to build single cabinets or entire kitchens! The CMT Tongue and Groove Set includes a matched set that produces a 1/4" x 1/4" tongue. The feature of the CMT system that sets it apart from other tongue and groove sets is that the tongue is offset to one side of the joint. This system produces a stronger joint creating a greater drilling area when used in conjunction with the CMT Pocket Pro™ and face frame screws. When the Pocket Pro™ is set at the one inch setting, the screw will bypass the tongue and get a full bite in the grooved section, producing a much stronger joint. In some cabinet making applications, it is necessary to trim portions of the tongue. For this reason, we have included a 1/2" shank flush trim bit to complete the three piece set.

The CMT tongue and groove joint is used in every element of cabinetry. When used in conjunction with the CMT Pocket Pro™ System you can combine the most appealing characteristics of traditional European joinery together with the newest techniques for crafting face frame joints, even in concealed areas where bottoms, sides and dividers are attached to the face frame.

You can be sure that you are buying an original CMT product by checking the tool shank. Only genuine CMT bits carry the one and only CMT Orange Tools mark! Packaged in a sturdy recloseable plastic case.

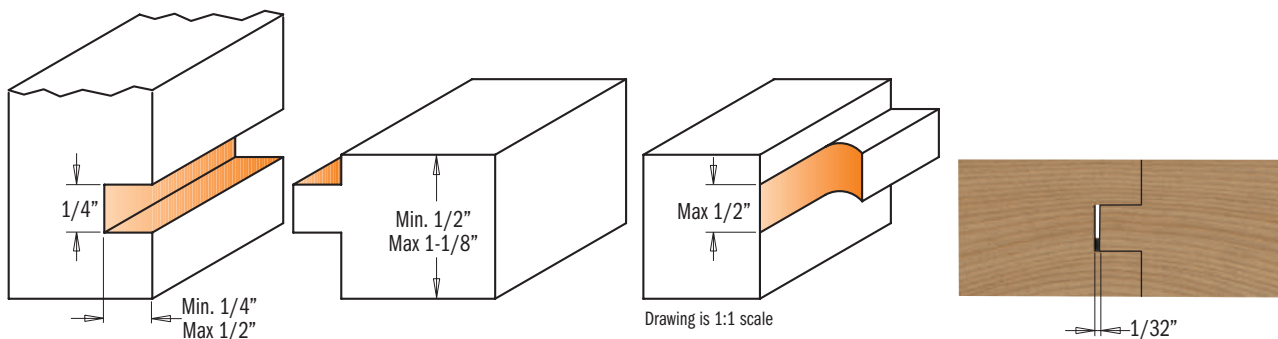

## 800.526.11 1/2" shank

SET CONTAINS	ORDER NO. S=Ø1/2" shank	D		I		L		B	
		inches	mm	inches	mm	inches	mm	inches	mm
Flush Trim	806.628.11	1/2	12.7	1/2	12.7	2-25/32	70.6	1/2	12.7
Rail & Stile	855.507.11	1-11/16	42.8	1-1/8	28.5	2-3/4	70	1-1/4	31.7



# 3-piece Entry & Interior Door router Bit Set



855.806.11



**INSTRUCTION MANUAL INCLUDED!**

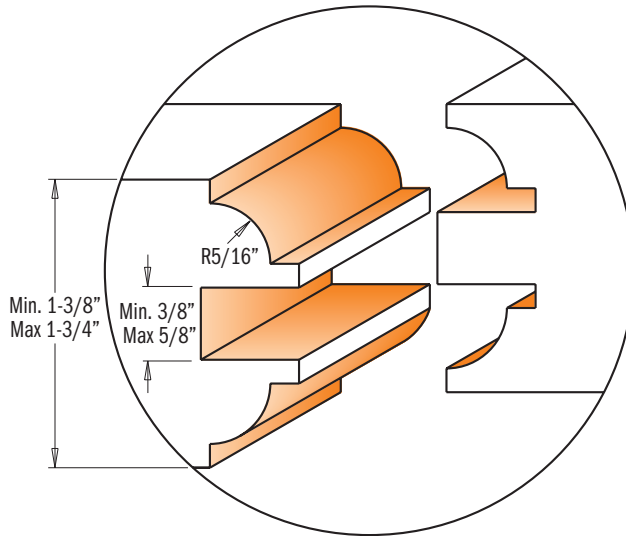

The new CMT three-piece set simplifies door construction, making it easy as 1-2-3! This handy multi-functional set creates fine entry and passage doors as well as beautiful furniture tenons. The featured tenon cutter produces a beefy 1-1/16" long tenons. Coupled with the cope cutter, strong tenons are a breeze and with minimum set up. As an extra bonus, the tenon cutter can be used for furniture making that requires a tenon anywhere from 3/16" to 5/8" in thickness. Packaged in a sturdy recloseable plastic case.



## ENTRY & INTERIOR DOOR CONSTRUCTION - EASY AS 1-2-3!

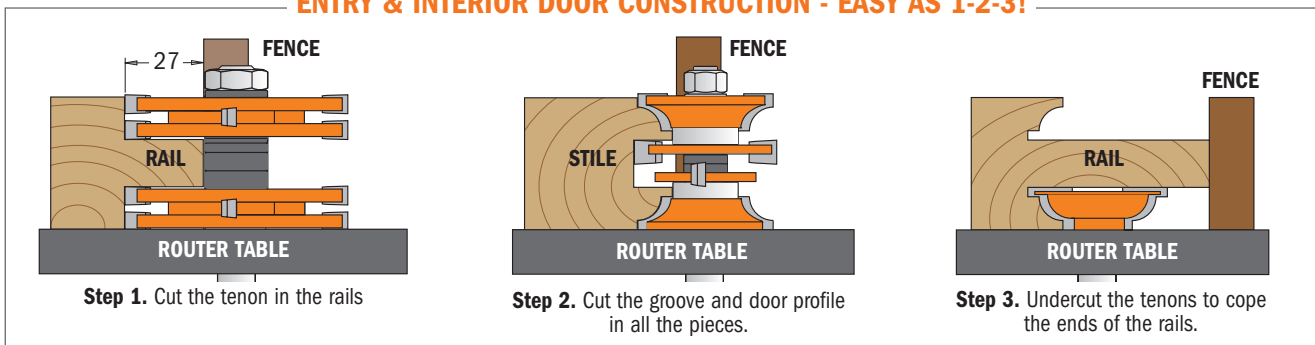

**800.527.11** 1/2" shank

SET CONTAINS	ORDER NO. S=Ø1/2" shank	D		I		T <sub>1</sub>	L		B
		inches	mm	inches	mm	inches	inches	mm	mm
Tenon Cutting Router Bit	<b>800.628.11</b>	3	76	1-3/4	44.5	3/8 to 5/8	3-15/16	100	
Rail & Stile Router Bit Set	<b>855.806.11</b>	1-7/8	47.6	1-3/4	44.5	1-3/8 to 1-3/4	4	101.6	22



# 3-piece Divided Light Door Set



PACK QTY.  
1 PC

Build authentic divided light doors for fine furniture and cabinets with this 3-piece set. The set includes a stick bit to cut the decorative ovolo profile on the frame edges, a cope bit which shapes the mating profile on the ends of the stock, and a rabbeting bit for cutting the recess for the glass. Because the bits have guide bearings you can also create arched or curved frames.

The unique design of the cope bit allows you to use full-length tenons to create strong, authentic mortise-and-tenon joinery. As the stock is coped, the tenon passes over the bit. The set is designed for 7/8" wide bars such as those on a corner cupboard door. Instructions included.

Note: You will need to produce mortise and tenon joints with a tenoning jig or other tools. Packaged in a sturdy recloseable plastic case.

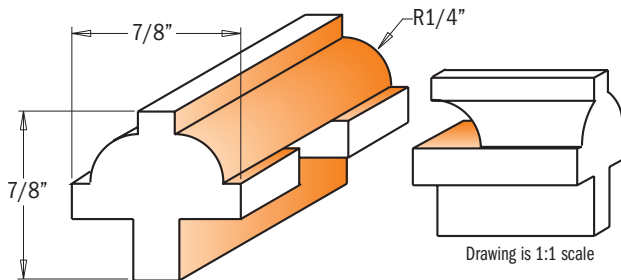

## 800.525.11 1/2" shank

SET CONTAINS	ORDER NO.	D		I		R		L		H	
	S=Ø1/2" shank	inches	mm	inches	mm	inches	mm	inches	mm	inches	mm
Rabbeting Bit	<b>835.850.11</b>	1-3/8	34.9	1/2	12.7			2-11/32	59.4	1/2	12.7
Rail & Stile Bits	<b>855.802.11</b>	1-1/4	31.7	1/2	12.7	1/4	6.35	2-1/4	57		

# 3-piece Glass Panel Set



CMT's unique stile and rail set allows you to produce glass panel doors utilizing a rubber panel retainer to secure the glass in a 1/8" slot cut into the frames. These 1/2" shank bits work the same as our other stile and rail sets, but leave you with a square rabbet on the inside of your door for glass installation. Packaged in a sturdy recloseable plastic case.

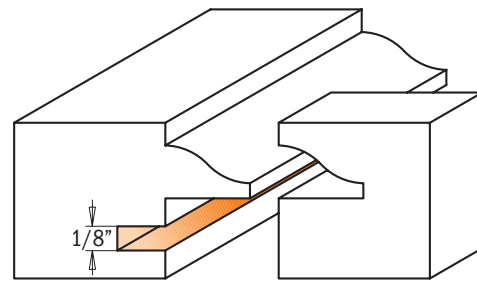
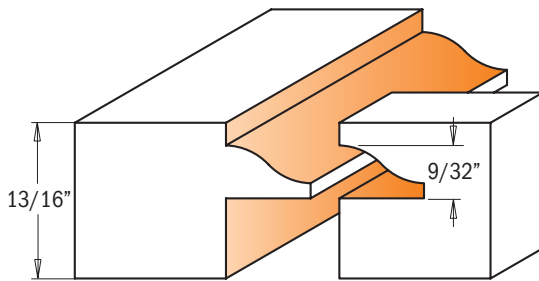

Drawing is 1:1 scale

**Here's how it works:**  
Mill the cope and pattern cuts first, then use the slot cutter to cut the groove for the rubber panel retainer. The edge of the pattern cut will ride on the bearing of the slot cutter bit. When you cut the slot in the rails you can cut the slot the full length of the stock. When you cut the slot in the stiles you need to set up reference points to stop and start the cuts so they are hidden from view on the top and bottom of the doors.



## 855.803.11 1/2" shank

SET CONTAINS	ORDER NO.	D		I		R		L	
	S=Ø1/2" shank	inches	mm	inches	mm	inches	mm	inches	mm
Ogee Rail & Stile Set	<b>855.803.11MF</b>	1-5/8	41.2	13/16	20.6	5/16	7.94	3-1/32	77
1/8" Slot Cutter	<b>822.016.11B</b>	2-1/8	53.9	1/8	3.17			2-13/64	55.9

# 7-piece Crown Molding Set



PACK QTY.  
1 PC

This set lets you make crown molding that surpasses anything you'll find at the lumberyard, and that's just the beginning! By arranging the profiles of the six router bits in various combinations you can create dozens - or hundreds - of different decorative profiles! The set consists of a 7" diameter, 5/8" arbor cove cutter for your table saw, and six 1/2" shank carbide tipped router bits. All six bits - three ogees and three roundovers - feature CMT's unique inverted design. Why use inverted profiles? Because the flat face of your workpiece always remains firmly anchored to your router table for unprecedented accuracy and control. Packaged in a sturdy recloseable plastic case.

## 800.523.11 1/2" shank

SET CONTAINS	ORDER NO. S=Ø1/2" shank
Inverted roman ogee profile - 5/32" radius	867.501.11B
Inverted roman ogee profile - 5/32" radius	867.502.11B
Inverted roman ogee profile - 1/4" radius	867.503.11B
Inverted roundover profile - 1/4" radius	867.601.11B
Inverted roundover profile - 5/16" radius	867.602.11B
Inverted roundover profile - 3/8" radius	867.603.11B
Cove cutter head - 7" diameter, 6 carbide teeth, 5/8" bore	235.006.07
Shim, 5/8" bore	299.011.00

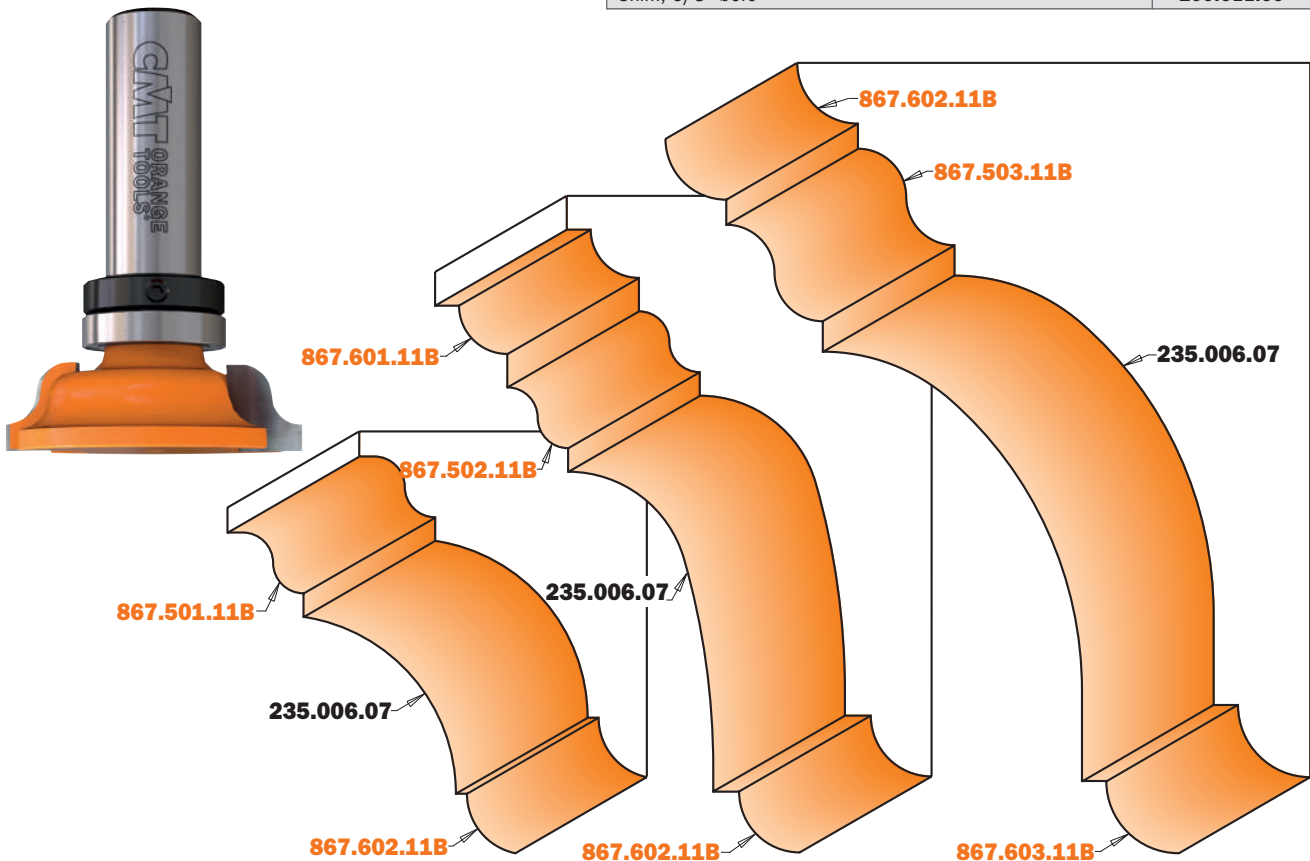

Drawing is 2:1 scale



## Creating decorative molding with CMT's Crown Molding Set

CMT's Crown Molding Set allows you to shape elegant moldings with your tablesaw and router table. The set consists of a cove cutter and six router bits with inverted profiles. The cove cutter mounts on your tablesaw and is used in conjunction with a pair of angled fences. Changing the fence angle and cutter height allows you to create an almost infinite variety of cove shapes and sizes. After milling the cove, you can use the special router bits with inverted profiles to complete the molding.

### PLAN YOUR CUTS

Begin with a drawing of your design or use one of the designs shown below. Next, sketch the cove outline on each end of the stock as shown at right.

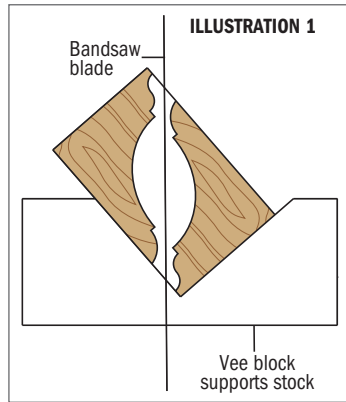

### PREPARE THE STOCK

In order to get the best possible yield from your stock, we suggest that you rip the stock diagonally on a bandsaw before milling the cove as shown in **illustration 1**.

### MOUNTING THE CUTTERHEAD

Begin by disconnecting the tablesaw from its power source and removing the blade. To mount the cutterhead, first position the 2-5/8" diameter spacer that came with the set against the flange on the saw arbor. The spacer will center the cutterhead within the throat plate opening. Next, position the cutterhead on the arbor and secure the assembly with the washer and arbor nut. Finally, place the dado throat plate in position. Before turning on the power, rotate the cutterhead by hand to be certain that it clears the throat plate.

### MILLING COVES

This process is very similar to cutting coves with a standard saw blade on a table saw. If this operation is new to you or if you have questions beyond the instructions, we highly recommend you take time to further study this technique in either a woodworking class or consult a woodworking book that teaches the safest way to perform this operation.

Always make your molding by milling the cove first while the stock has the greatest mass. To safely use the cove cutter, it's necessary to have a dado head insert plate for your saw. Use a dual fence set up as shown in **illustrations 2 & 3** to guide and support the workpiece as the cove is shaped. The fences are clamped to the top of the tablesaw and the stock passes between them, running at an angle to the cutting blade. With the cutterhead height set at the depth of the cove to be cut, position a fence at an angle so that the stock enters the cutter along the left leading edge and exits the stock along the right trailing edge.

Before making the first cut, lower the cutterhead to 1/16" above the table top. Turn on the power and feed the stock slowly between the fences; after each pass raise the cutterhead another 1/16".

Remember to use a guard and push blocks for added safety.

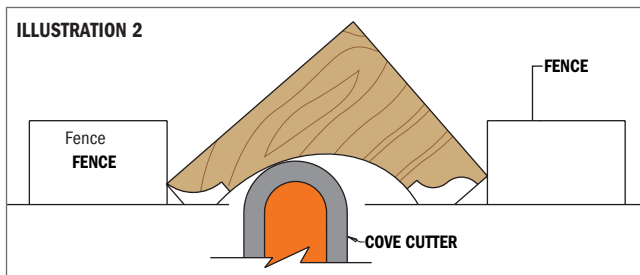

**ILLUSTRATION 3: Creating different coves with different fence angles**

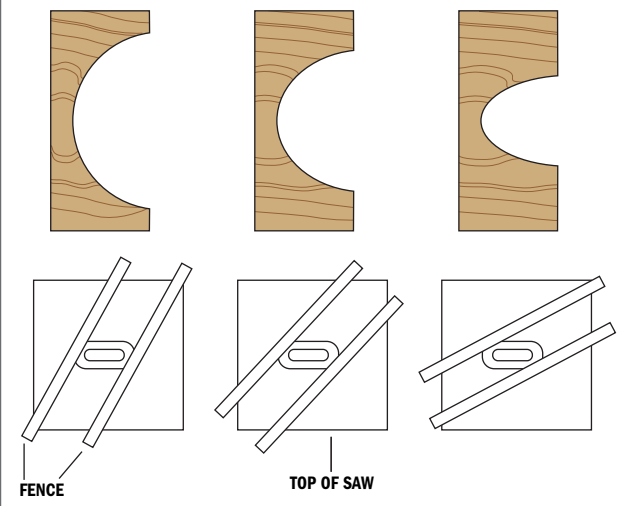

### ROUTING MOLDINGS WITH THE INVERTED BITS

Because the profiles are inverted on the shank, you can rout large moldings that are impossible to shape with ordinary router bits.

Before routing, always begin with a drawing of the molding that you would like to produce. Remember, begin by shaping the cove with the cove cutter on your tablesaw, then set up the routing tasks.

Afterwards, rout the profiles that flank each side of the cove. Use your router table and a fence for the best support of the stock.

For added safety and the smoothest possible surface, always take multiple light cuts and support the workpiece with featherboards.

### MILLING CURVED MOLDINGS

The inverted router bits each have a bearing mounted on the shank. This feature allows you to shape curved profiles such as gooseneck and circular moldings. When routing curved moldings, first attach a plywood template to the workpiece to serve as a guide for the bearing to ride on.

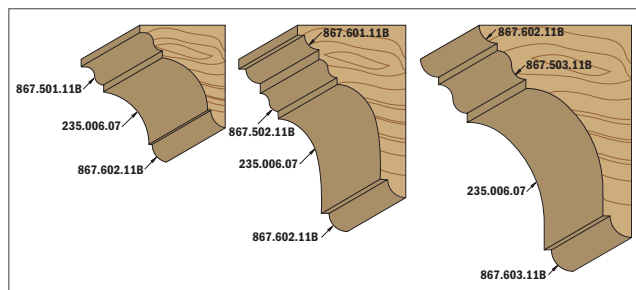



# NEW CONTRACTOR ROUTER BITS BY CMT



Deluxe packaging



For value-driven contractors,  
remodelers and DIYers.  
Great quality/price ratio  
and long-lasting performance.



#### HEAT-TREATED SHANK & BODY FOR GREATER DURABILITY

The bits are made from the finest steel hardened to reach 58 Rockwell which ensures durability and good cutting performance.

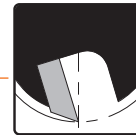

#### ANTI-KICKBACK DESIGN

Controls depth of cut and minimizes kickback reducing your risk of injury.



#### SINTERHIP HI-DENSITY CARBIDE

New process called SinterHIP (Hot Isostatic Pressing), helps prevent material failure and increases cutting life.



#### CORROSION-FREE BLACK COATING

Protects against corrosion and provides a longer bit life.

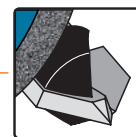

#### PRECISION GROUND CUTTING EDGES

Each cutting edge is precisely sharpened to obtain a sharp and durable cutting angle.

# Mortising Bits

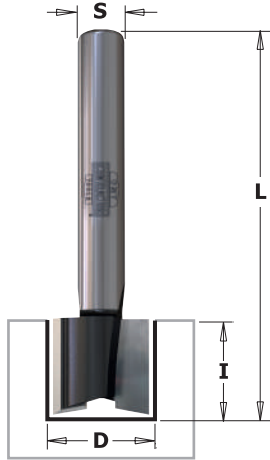

## 801

Hi-Density carbide cutting edges provide good performance in mortising applications eliminating splintered edges and rough bottoms. Works well on natural wood and wood composites.



ORDER NO.	S=01/4" shank	D		I	L
		inches	mm		
80101	10	1/2	12.7	1/2	2
80105	10	5/8	15.87	25/32	2
80107	10	3/4	19.05	25/32	2

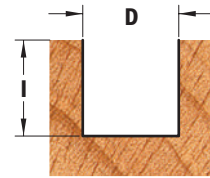

Drawing is 1:1 scale

# Straight Bits



## 811

Designed for making slots and routing channels in wood and wood composites. Hi-Density carbide-tipped cutting edges provide smooth performance and a precise cut. Engineered for efficient chip clearance.



ORDER NO.	S=01/4" shank	D		I	L
		inches	mm		
81103*	10	1/8	3.2	5/16	2
81105*	10	3/16	4.75	1/2	2
81108*	10	1/4	6.35	5/8	1-7/8
81203	10	1/4	6.35	1	2-1/2
81112	10	5/16	8	1	2-1/4
81115	10	3/8	9.52	1	2-3/16
81119	10	1/2	12.7	1	2-3/16
81208	10	1/2	12.7	1-1/4	2-7/16
81125	10	5/8	15.87	1	2-3/16
81131	10	3/4	19.05	1	2-3/16

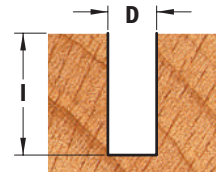

Drawing is 1:1 scale

\*T1

# Pattern Bits



## 811

Our pattern bit makes template routing easy and accurate. Create cabinets, furniture, signs, toys or just about any other project you can imagine. Our smooth-running top bearing will glide along your template creating a perfect copy in the wood piece below.



ORDER NO.	S=01/4" shank	D		I	L
		inches	mm		
81120	10	1/2	12.7	1	2-11/16

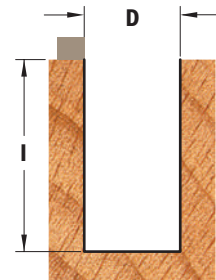

Drawing is 1:1 scale

**Flush Trim Bits**

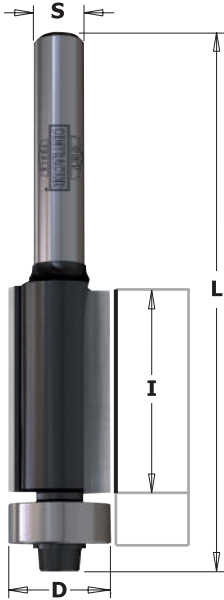

**806**



Precise flush trimming of wood or laminate material. Bottom bearing runs effortlessly against finished work piece delivering a smooth to the touch flush trim cut. Two carbide-tipped cutting edge design optimizes performance.

ORDER NO. S=01/4" shank		D		I	L
		inches	mm	inches	inches
80603	10	3/8	9.52	9/16	2-3/16
80604	10	1/2	12.7	1	2-5/8
80605	10	1/2	12.7	1/2	2-3/16

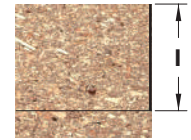

Drawing is 1:1 scale

**Laminate Trimmer Bits**



84201

84301



**842 - 843**



Solid Sinterhip Hi-Density Carbide provides a sharp cutting edge and long life. Features a self-pilot tip and radial relief edge. You can choose either a flush or 7° bevel cut on laminate edge.

ORDER NO. S=01/4" shank		D		I	A	L
		inches	mm	inches		inches
84201	10	1/4	6.35	3/8	0°	1-1/2
84301	10	1/4	6.35	1/4	7°	1-1/2

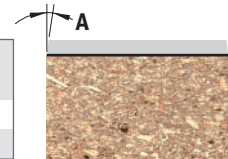

Drawing is 1:1 scale

**Panel Pilot Bits**

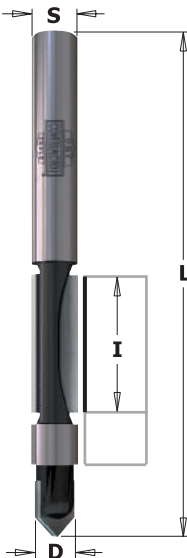

**816**

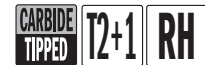

Quickly cut openings in panel, drywall and siding for door and window openings. Features a sharpened carbide tip for plunging and two carbide cutters for fast, smooth cuts. Ideal for trimming veneered boards, laminates and FORMICA®.



ORDER NO. S=01/4" shank	ORDER NO. S=01/2" shank		D		I	L
			inches	mm	inches	inches
81601		10	1/4	6.35	3/4	2-5/8
	81651	10	1/2	12.7	1	3-5/8

# Rabbeting Bits

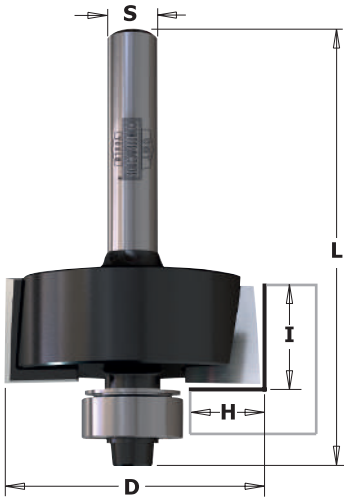

**835**



Ideal for creating inset doors and drawer fronts or to re-groove old window frames to accept a panel of glass. Features two carbide-tipped cutting edges, anti-kickback design with heat treated shank and body for durability. Bottom bearing included.

ORDER NO.		D		I	H	L
S=Ø1/4" shank		inches	mm	inches	inches	inches
83501	10	1-1/4	31.7	1/2	3/8	2-1/8
83503	10	1-1/2	38.1	1/2	1/2	2-1/8

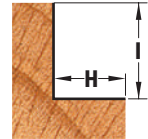

Drawing is 1:1 scale

# Keyhole Bit

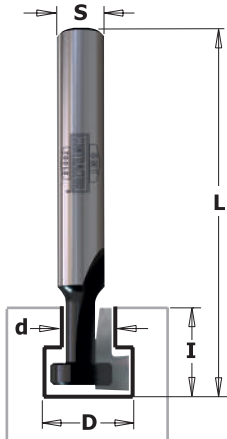

**850**



Easily create a hardware-free way to hang pictures and plaques on a wall. Cuts a key-holed groove or slot in a variety of materials such as wood, plywood and laminates.

ORDER NO.		D		d	I	L
S=Ø1/4" shank		inches	mm	inches	inches	inches
85001	10	3/8	9.52	3/16	7/16	1-7/8

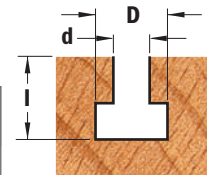

Drawing is 1:1 scale

# Dovetail Bits

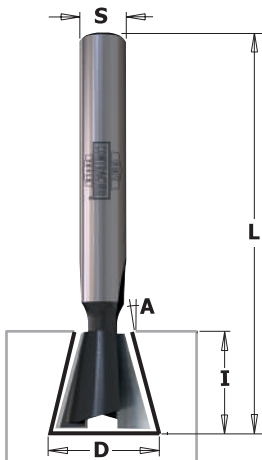

**818**



Use our bits with some of the most popular dovetail jigs on the market to create clean dovetail joints in wood and wood composite material. Balanced for good performance.

ORDER NO.		D		I	A	L
S=Ø1/4" shank		inches	mm	inches		inches
81809	10	3/8	9.52	3/8	9°	1-3/4
81815	10	1/2	12.7	1/2	15°	2-1/16
81821	10	9/16	14.2	1	7.5°	2-5/8

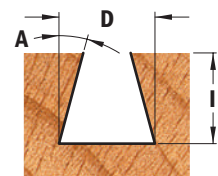

Drawing is 1:1 scale



## Chamfer Bit

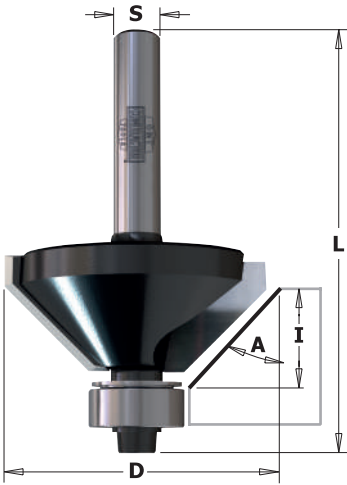

**836**



Produce clean, accurate bevel or chamfer edges for edge jointing, decorative edges or perfectly aligned boxes. Features two carbide-tipped cutting edges, anti-kickback design with heat treated shank and body for durability. Bottom bearing included.

ORDER NO.		D		I	A	L
S=Ø1/4" shank		inches	mm	inches		inches
83605	10	1-3/8	34.9	7/16	45°	2-3/16

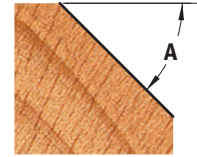

Drawing is 1:1 scale

## V-Grooving Bits

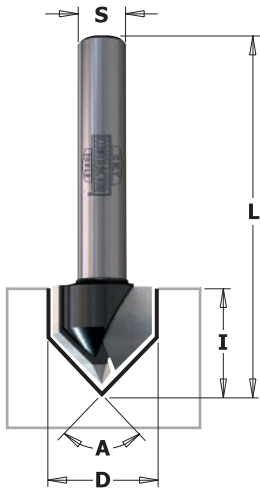

**858 - 815**



Make a clean sharp V-groove in panel and drawer fronts for decorative projects. Good for engraving letters for signs, they feature two sharp carbide-tipped cutting edges for smooth fast cutting. Choose from our 60° or 90° V-groove angle.

ORDER NO.		D		I	A	L
S=Ø1/4" shank		inches	mm	inches		inches
85801	10	7/16	11	9/16	60°	1-3/4
81503	10	1/2	12.7	1/2	90°	1-3/4

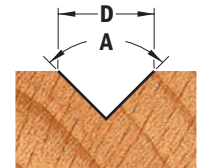

Drawing is 1:1 scale

## Round Nose Bits

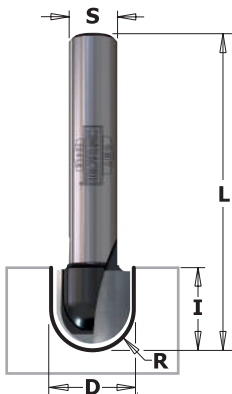

**814**



Designed for professional sign and cabinet makers. Use the round nose to make decorative doors, drawer fronts, signs or add a design to any other creative project. Features two carbide-tipped cutting edges which provide a smooth cut in wood and wood products.

ORDER NO.		D		I	R	L
S=Ø1/4" shank		inches	mm	inches	inches	inches
81410	10	1/4	6.35	3/8	1/8	1-9/16
81411	10	3/8	9.52	3/8	3/16	1-9/16
81404	10	1/2	12.7	1/2	1/4	1-9/16
81412	10	5/8	15.87	1/2	5/16	1-3/4
81408	10	3/4	19.05	1/2	3/8	1-13/16

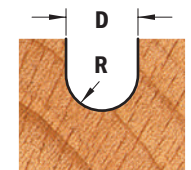

Drawing is 1:1 scale

## Cove Bits

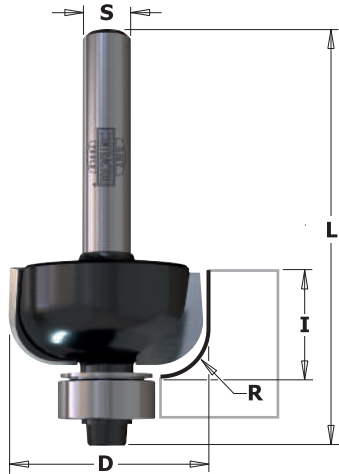

**837**



Give your doors and drawer fronts an elegant touch. Pair a cove bit with a roundover bit to create decorative elements on your furniture projects. Features two carbide-tipped cutting edges, anti-kickback design, heat treated shank and body for durability. Bottom bearing included.

ORDER NO.		D		I	R	L
S=01/4" shank		inches	mm	inches	inches	inches
83702	10	1	25.4	1/2	1/4	2-1/8
83704	10	1-1/4	31.7	9/16	3/8	2-3/16
83705	10	1-1/2	38.1	5/8	1/2	2-7/16

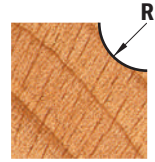

Drawing is 1:1 scale

## Cove & Fillet Bits

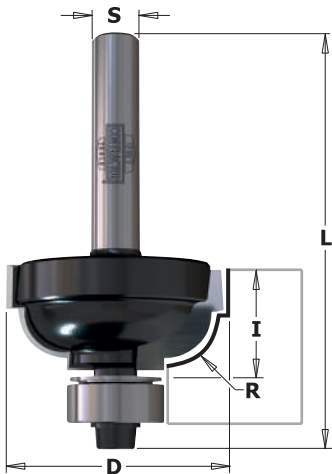

**863**



Cove & fillet bits are a perfect option to add elegance to your furniture! These bits combine a traditional cove cut with a fillet cut to create an eye-catching effect. They feature two carbide-tipped cutting edges, anti-kickback design and a heat treated shank and body for unbeatable durability. Bottom bearing included.

ORDER NO.		D		I	R	L
S=01/4" shank		inches	mm	inches	inches	inches
86301	10	1	25.4	1/2	3/16	2-1/8
86303	10	1-1/8	28.5	17/32	1/4	2-1/8
86304	10	1-3/8	34.9	21/32	3/8	2-5/16

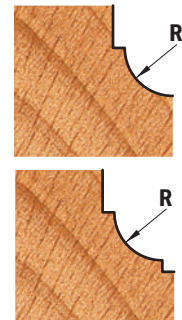

Drawing is 1:1 scale

EACH BIT INCLUDES A 3/8" BEARING FOR BEADING PROFILES

## Roundover & Beading Bits

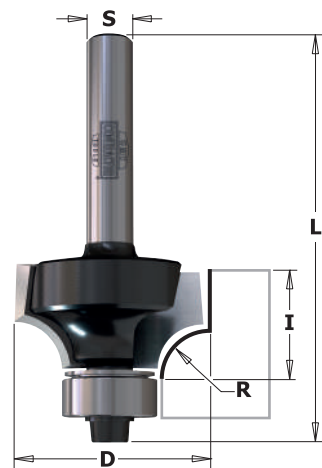

**838**



A popular profile for taking the edge off a sharp corners. When partnered with a cove bit, you can create a drop-leaf table or other intricate projects. Bits equipped with two carbide-tipped cutting edges, anti-kickback design, and heat treated shank/body for increased durability. Bottom bearing included.

ORDER NO.		D		I	R	L
S=01/4" shank		inches	mm	inches	inches	inches
83801	10	5/8	15.87	5/16	1/16	2
83802	10	3/4	19.05	27/64	1/8	2-1/16
83803	10	7/8	22.2	1/2	3/16	2-1/8
83804	10	1	25.4	17/32	1/4	2-1/8
83806	10	1-1/4	31.7	21/32	3/8	2-1/4
83807	10	1-1/2	38.1	3/4	1/2	2-3/8
83808	10	1-3/4	44.5	7/8	5/8	2-5/8

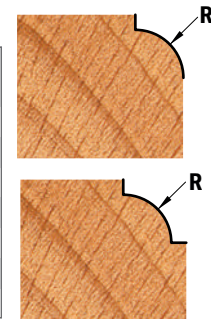

Drawing is 1:1 scale

EACH BIT INCLUDES A 3/8" BEARING FOR BEADING PROFILES

## Bull Nose Bit

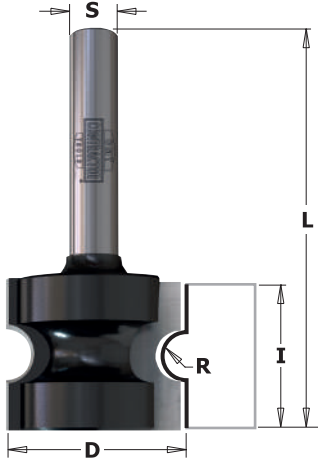

**854**



Ideal for shaping the full edge of any work piece with a smooth bull nose radius. Create a bull nose edge on stair treads, window sills, table tops, shelves, molding and counters. Good for use on natural wood and wood-based materials.

ORDER NO.		D		I	R	L
S=01/4" shank		inches	mm	inches	inches	inches
85401	10	7/8	22.2	3/4	1/8	2

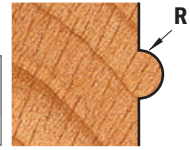

Drawing is 1:1 scale

## Convex Edge Bit



**854**



Used for cutting shallow bull nose profiles and creating a soft, slightly rounded edge on natural wood and wood-based material. Features two carbide-tipped cutting edges, antikickback design and heat treated shank and body for increased durability.

ORDER NO.		D		I	R	L
S=01/4" shank		inches	mm	inches	inches	inches
85411	10	13/16	20.6	1-1/4	23/32	2-1/2

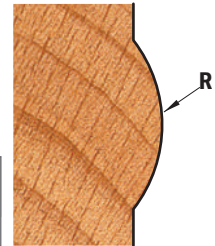

Drawing is 1:1 scale

## Ovolo Bit



**827**



Ideal for furniture makers, you get a roundover with top and bottom bead all in one. Bit equipped with two carbide-tipped cutting edges, features anti-kickback design and heat treated shank and body for increased durability.

ORDER NO.		D		I	R	L
S=01/4" shank		inches	mm	inches	inches	inches
82706	10	1	25.4	9/16	1/4	1-13/16



Drawing is 1:1 scale

## Corner Bead Bit

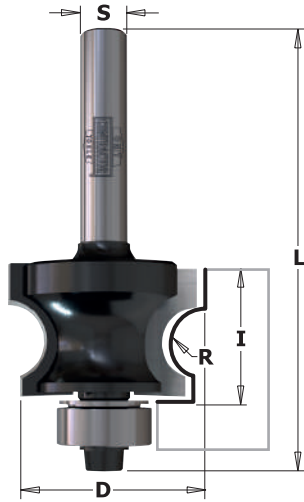

**861**



Used for antique reproduction, restoration projects and furniture details. This tool may look like a bull nose bit, but a smaller cutting diameter adjacent to the bearing gives a truly unique shape. Make one pass to mill an attractive rounded edge, or two passes to mill a full-round corner bead. Features two carbide-tipped cutting edges, anti-kickback design and heat treated shank and body for durability. Bottom bearing included.

ORDER NO.		D		I	R	L
S=01/4" shank		inches	mm	inches	inches	inches
86102	10	1	25.4	11/16	3/16	2-5/16

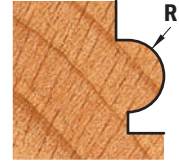

Drawing is 1:1 scale

## Plunge Ogee Bit

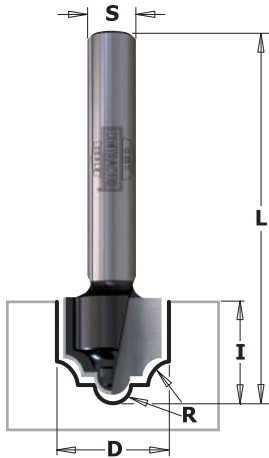

**848**



Lots of creative applications are possible with this bit. Add a classic touch to any edge or highlight door fronts and panels with a decorative layered effect. Features two carbide-tipped cutting edges, along with heat treated shank and body for durability.

ORDER NO.		D		I	R	L
S=01/4" shank		inches	mm	inches	inches	inches
84805	10	1/2	12.7	1/2	3/32	1-13/16

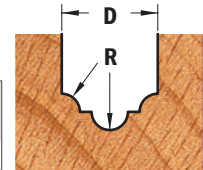

Drawing is 1:1 scale

## Decorative Ogee Bit

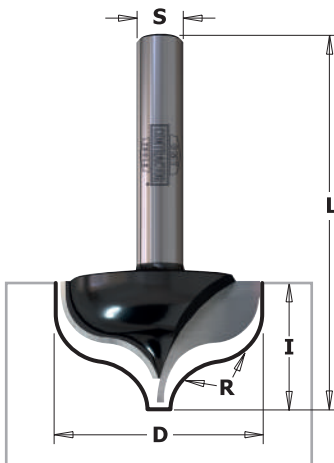

**865**



Use this tool to make decorative veining or edges on doors and drawer fronts. Equipped with two carbide-tipped cutting edges and heat treated shank and body for durability.

ORDER NO.		D		I	R	L
S=01/4" shank		inches	mm	inches	inches	inches
86508	10	1-1/32	26.1	5/8	1/4	1-7/8

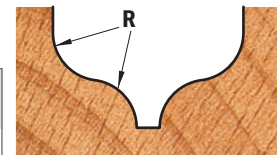

Drawing is 1:1 scale



## Roman Ogee Bits

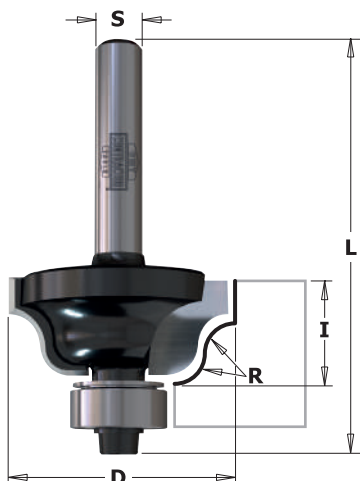

**840**



A very popular bit for making a wavy profile which, gives a touch of class to your furniture. These bits feature an anti-kickback design, rust-resistant black coating and include a smooth running bearing for template work.

ORDER NO. S=Ø1/4" shank		D		I	R	L
		inches	mm	inches	inches	inches
84001	10	1-1/8	28.5	1/2	5/32	2-1/8
84002	10	1-1/2	38.1	11/16	1/4	2-3/8



Drawing is 1:1 scale

## Ogee with Fillet Bit

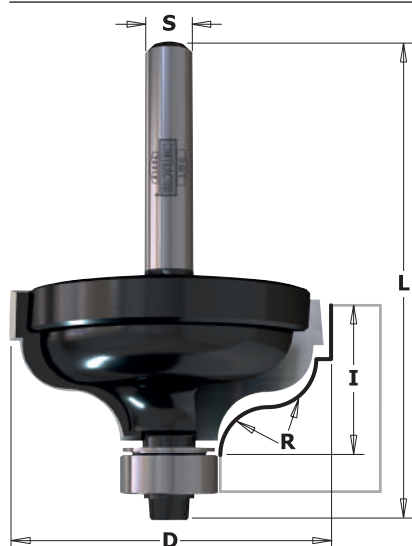

**846**



Create a wavy shape with a fillet on top for your project. This tool is equipped with carbide-tipped cutting edges, features anti-kickback design and heat treated shank and body for durability. Bottom bearing included.

ORDER NO. S=Ø1/4" shank		D		I	R	L
		inches	mm	inches	inches	inches
84602	10	1-5/8	41.2	3/4	1/4	2-7/16

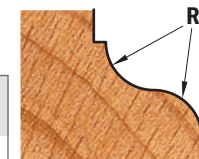

Drawing is 1:1 scale

## Ogee Bit

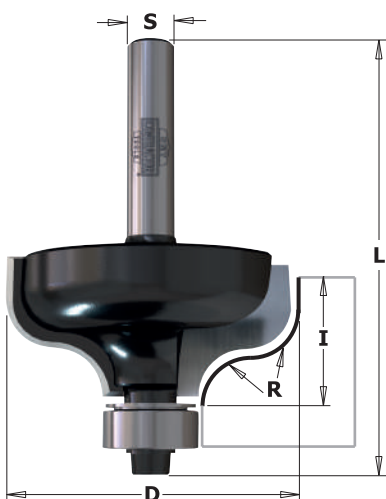

**859**



Create a defined wavy shape to the edge of your furniture and cabinets with this traditional ogee bit. Bit features two carbide-tipped cutting edges and anti-kickback design. Bottom bearing included.

ORDER NO. S=Ø1/4" shank		D		I	R	L
		inches	mm	inches	inches	inches
85902	10	1-1/2	38.1	5/8	1/4	2-1/4

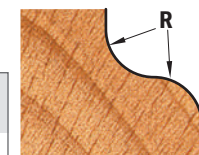

Drawing is 1:1 scale

## Classical Ogee Bit

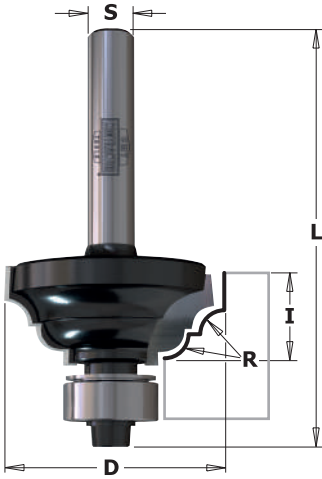

**841**



These bits produce both a concave and a convex profile on your work piece for smooth eye-catching detail! They feature 2 sharp cutting edges, rust-resistant black coating and are equipped with a bottom bearing for easy template work on both natural wood and wood-based materials.

ORDER NO.		D		I	R	L
S=Ø1/4" shank		inches	mm	inches	inches	inches
84103	10	1-1/8	28.5	1/2	1/8	2-1/8



Drawing is 1:1 scale

## Classical Ogee Bit

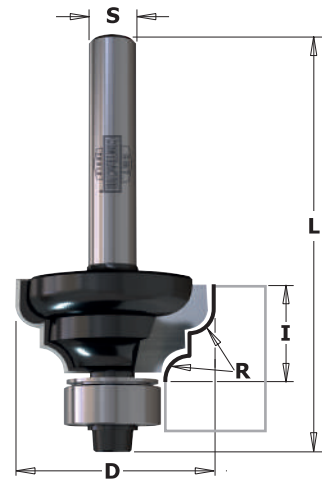

**844**



Get an inverted ogee profile with the concave edge adjacent to the upper surface of your work-piece! Equipped with 2 sharp cutting edges and featuring rust-resistant black coating, this tool defines edges with a horizontal bead along the bottom of the cut. A smooth running bearing makes template work easy on both natural wood and wood-based materials.

ORDER NO.		D		I	R	L
S=Ø1/4" shank		inches	mm	inches	inches	inches
84403	10	1	25.4	1/2	1/8	2-1/8



Drawing is 1:1 scale

## Replacement Bearing Set

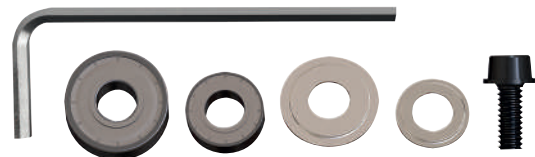

PACK QTY.  
10 PC

**79101**

SET CONTAINS	PIECES
3/8" Bearing	1
1/2" Bearing	1
3/8" Dust Shields	1
1/2" Dust Shields	1
Hex Key	1
Screw	1



PACK QTY.  
1 PC



**80004** 4-PIECE ROUNDROVER SET 1/4" shank

SET CONTAINS	D		I	R	L
	inches	mm			
<b>83802</b>	3/4	19.05	27/64	1/8	2-1/16
<b>83804</b>	1	25.4	17/32	1/4	2-1/8
<b>83806</b>	1-1/4	31.7	21/32	3/8	2-1/4
<b>83807</b>	1-1/2	38.1	3/4	1/2	2-3/8



PACK QTY.  
1 PC



**80005** 5-PIECE STRAIGHT SET 1/4" shank

SET CONTAINS	D		I	L	T
	inches	mm			
<b>81103</b>	1/8	3.2	5/16	2	1
<b>81108</b>	1/4	6.35	1/2	2	1
<b>81115</b>	3/8	9.52	1	2-3/16	2
<b>81119</b>	1/2	12.7	1	2-3/16	2
<b>81131</b>	3/4	19	1	2-3/16	2

# Hinge Boring System

The innovative **CMT333** Hinge Boring System with 3 spindle-heads allows you to bore holes for any hinge brand. The universal modular base supports the installation of many boring heads engineered by worldwide leading companies in the sector. Use the **CMT333** universal hinge boring system on all hand-held or standing drill press tools.

## CMT333-03



Check out the **CMT333** on **YouTube**

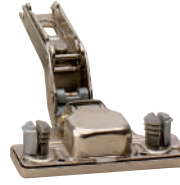

For use on drill presses



For use with portable drills

### Technical Features and Specifications:

- Metal parts are anti-rust
- Aluminum alloy
- Max 5000 RPM
- Six radial anti-friction bearings
- Ground chromium plated slide bars (Maximum Length=90mm)

### The complete system CMT333-03 contains:

- **CMT333** the modular base support
- **CMT333-4595** boring head
- **317.350.11** Ø35mm hinge boring bit.

### Not included:

- 310.080.12** Ø8mm Dowel Drills

### Spare parts

	
990.009.00	991.067.00

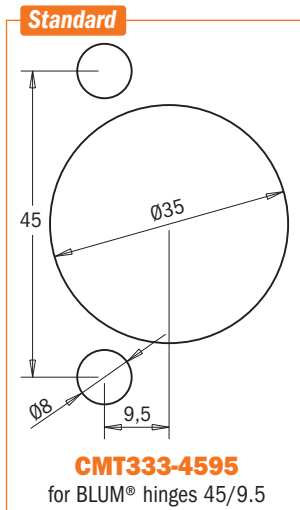

Example BLUM® hinge

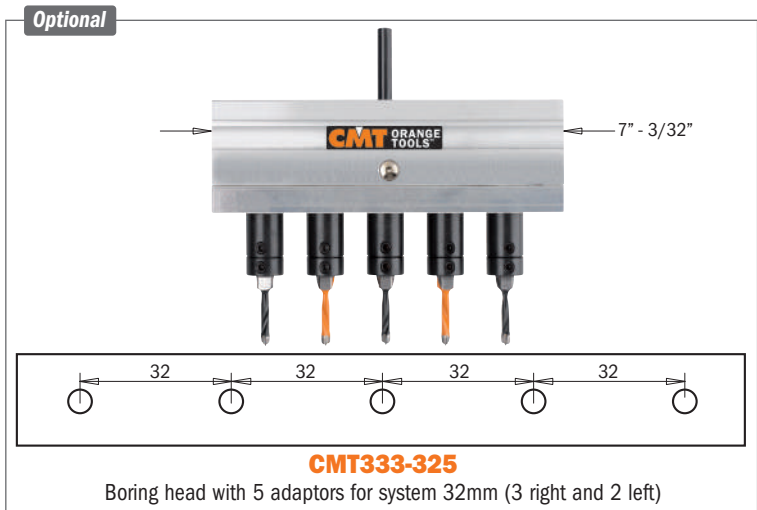



## BLUM® Hinge Boring Head

The innovative **CMT334** BLUM® Hinge Boring Head features three spindles which allow you to bore hinge holes cleanly and efficiently. For use on boring and point-to-point machines.

**CMT334**



ORDER NO.	DESCRIPTION
<b>CMT334-4595</b>	Hinge Boring Head (bits not included)
<b>393.350.11</b>	Boring Bit Ø35mm x 38.5mm. Right-hand rotation
<b>393.080.12</b>	Dowel Drill Ø8mm x 38.5mm. Left-hand rotation

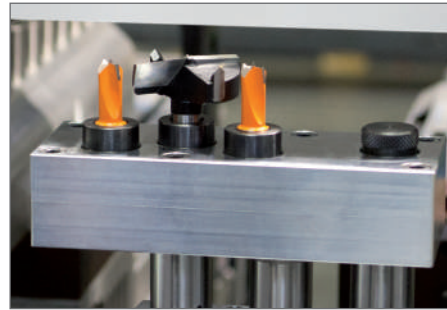
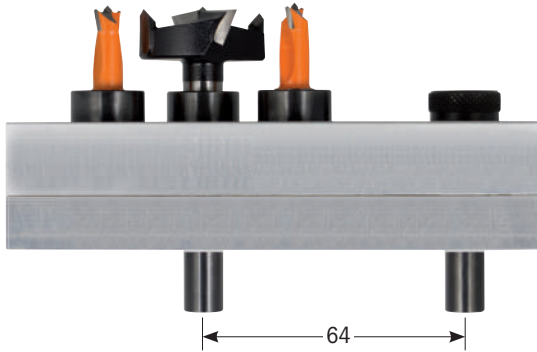

For use on boring and point-to-point machines

Standard

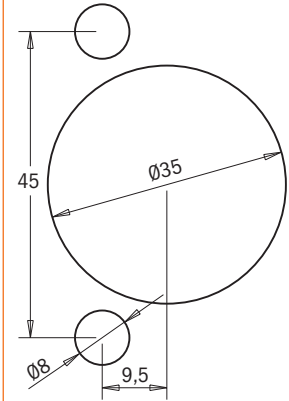

**CMT334-4595**  
for BLUM® hinges 45/9.5

## Inlay Kit

Beautiful, professional-quality inlays aren't as difficult as they seem. In fact, they're easy with a CMT Inlay Kit. Solid brass components come with either a solid carbide spiral bit or straight bit with 1/8" cutting diameter and 1/4" shank. Just remove and reassemble the small bushing to make the recess in the workpiece and cut out the inlay. Perfect for toymaking, puzzle making, lettering and lots of other decorative projects. Use the spiral bit for routing MDF, or the straight bit for natural wood.



**899**

ORDER NO.	DESCRIPTION
<b>899.051.00</b>	Inlay kit with 1/8" solid carbide spiral bit (Ø1/4" shank)
<b>899.052.00</b>	Inlay kit with 1/8" solid carbide straight bit (Ø1/4" shank)
<b>899.001.00</b>	Universal router base
<b>192.001.11</b>	1/8" HWM spiral bit (Ø1/4" shank)
<b>812.032.11</b>	1/8" HWM straight bit (Ø1/4" shank)

# Pocket-Pro Joinery System



For fast, easy and accurate cabinet & furniture construction. Designed by CMT and professional cabinetmakers, this new system allows you to make rock-solid pocket hole joints in stock 1/2" (12.7mm) to 1-5/8" (41.3mm) thick with unprecedented speed and accuracy.

# PPJ-002

The heart of the Pocket-Pro System is our unique moulded jig, which features hardened drill bushings and an interlocking two-piece design. Sliding the jig up or down enables you to adjust the stock thickness in preset 1/16" (1,6mm) increments without test joints or measurements! If you have used other pocket hole jigs you will be familiar with many joint applications, but you will benefit from many Pocket-Pro System advantages.

For example:

- some jigs require adding or removing various parts of the jig to join different stock thicknesses. With the Pocket-Pro System you simply have to adjust the interlocking jig up or down for the full range of joints 1/2" (12.7mm) to 1-5/8" (41.3mm) thick;
- other jigs require frequent repositioning of the depth stop collar for different joint styles. CMT's Pocket-Pro Joinery System allows you to make most of the adjustments leaving the stop collar in the same position of the drill bit;
- plus, with CMT's Pocket-Pro System you can quickly adjust the location of the pocket in relation to the end of your workpiece to create a stronger joint by using longer screws, or to leave more "meat" in the joint.

Check out the Pocket-Pro Joinery System today. Easy enough for beginners and accurate enough for professional workers, it is the world's most versatile pocket hole jig.



ORDER NO.	DESCRIPTION
<b>PPJ-002</b>	Pocket-Pro Joinery System set
<b>Set contains:</b>	
<b>999.505.10</b>	Pocket-Pro main parts
<b>999.505.05</b>	Toggle clamp
<b>515.001.51</b>	Ø3/8" (9.52mm) step drill bit
<b>541.095.00</b>	Ø3/8" (9.52mm) depth collar for step drill bit
<b>999.505.08</b>	L=6" (152mm) Square drive screw driver bit
<b>990.101X30</b>	Masterpack 30 screw L=1-1/4" (31.7mm)

ORDER NO.	DESCRIPTION OPTIONAL
<b>990.101X500</b>	500 fine screws L=1-1/4" (31.7mm)
<b>990.102X500</b>	500 coarse screws L=1-1/4" (31.7mm)
<b>990.103X500</b>	500 fine screws L=1-1/2" (38.1mm)
<b>990.104X500</b>	500 coarse screws L=1-1/2" (38.1mm)

Watch the video on



## ENJOY EASY POCKET HOLE JOINERY!

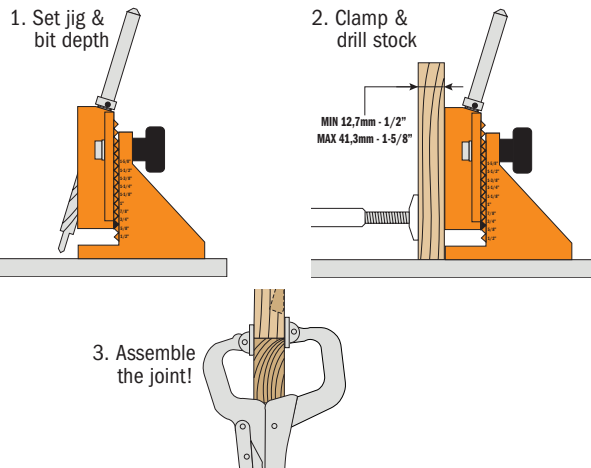

## BUILD ALMOST ANYTHING!

Face Frames

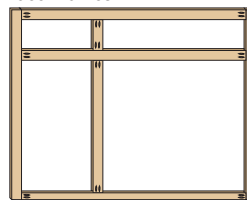

Cabinets and more!

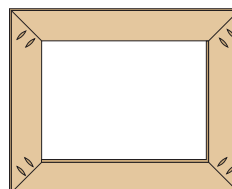
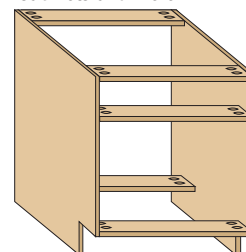

Picture Frames

# Universal Dovetail Jig



## CMT300

Max Length 12"  
Joint Thickness 7/16"~1"

Dovetail joints give a touch of craftsmanship to your work, but many woodworkers avoid these joints, because of their apparent complexity. CMT's new 12" dovetail jig is the fast easy solution! Thanks to precise templates, permanent stops and easy adjustments, we have taken the "tinkering" out of dovetail joinery. Simply clamp your workpiece in with the edges against the factory-set stops, set your bit depth and then you are ready to rout. Rest assured, we haven't cut corners on quality! This jig features a steel body, templates, stops and clamping bars, so it produces perfect long-lasting joints for all your woodworking needs. The machine accepts stock from 7/16" to 1" thickness, and is capable of producing a variety of joints with the available templates. Standard jig includes a template for 1/2" half blind joints and a template guide. Optional templates are available for through dovetail and box joints.

ORDER NO.	DESCRIPTION
CMT300	Universal Dovetail Jig

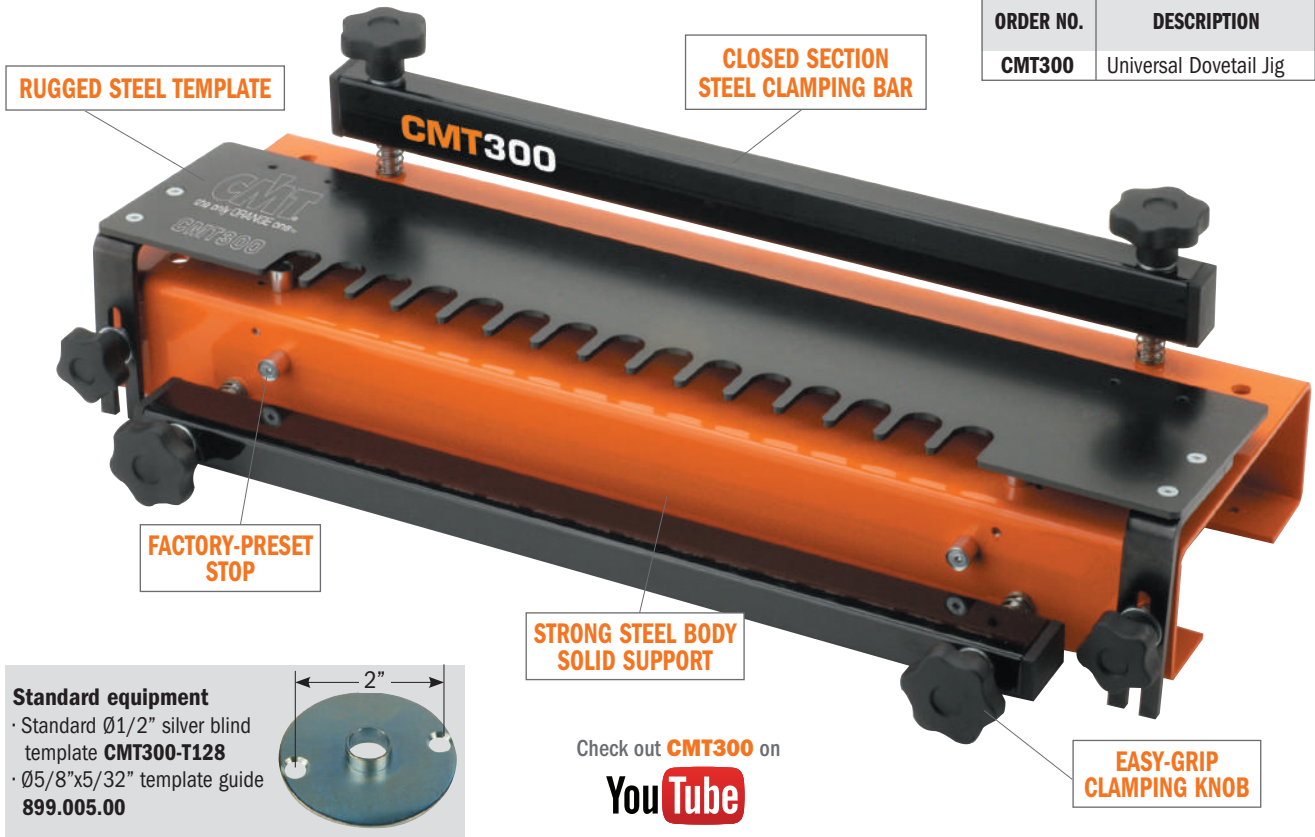

**Standard equipment**

- Standard Ø1/2" silver blind template **CMT300-T128**
- Ø5/8"x5/32" template guide **899.005.00**

Check out **CMT300** on **YouTube**

### IMPORTANT TIP



- TCT DOVETAIL BITS (not included):**
- 818.128.11** D=1/2" A=14° S=1/4"
  - 818.628.11** D=1/2" A=14° S=1/2"



#### Will the template fit my router?

Standard template guide features two prebored holes with 2" center-to-center distance and attaches via two screws. Many routers are compatible with this design. However, if yours is not, choose from the list of universal router bases here below:

**Universal router bases**  
For Ø1/4" and Ø1/2" shank

**ORDER NO.**  
**CMT300-SB2**

#### Here's how it works:





## Half Blind Template **CMT300-T064**

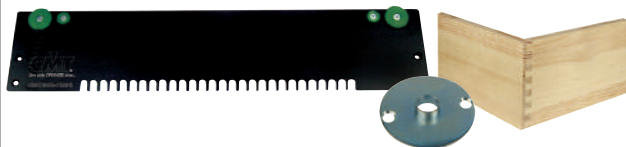

ORDER NO.	TEMPLATE LENGTH inches	DOVETAIL SIZE inches	THICKNESS inches	COLOUR
<b>CMT300-T064</b>	12	1/4	5/16 ~ 15/32	<b>green</b>

**899.003.00** Supplied with  $\varnothing 5/16 \times 5/32$ " precision guide

To be used with CMT dovetail router bits:

**818.064.11** Dovetail bit  $\varnothing 1/4 \times 5/16$ " (shank  $\varnothing 1/4$ ")



## Through Dovetail Templates **CMT300-T129**

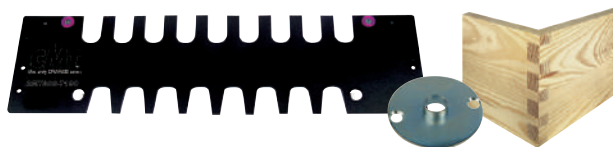

ORDER NO.	TEMPLATE LENGTH inches	DOVETAIL SIZE inches	THICKNESS inches	COLOUR
<b>CMT300-T129</b>	12	1/2	5/16 ~ 25/32	<b>brown</b>

**899.004.00** Supplied with  $\varnothing 7/16 \times 5/32$ " precision guide

To be used with CMT router bits:

**811.081.11** Straight bit  $\varnothing 5/16 \times 1$ " (shank  $\varnothing 1/4$ ")

**818.129.11** Dovetail bit  $\varnothing 1/2 \times 13/16$ " (shank  $\varnothing 1/4$ ")



## Box Joint Templates **CMT300-T080 - CMT300-T127**

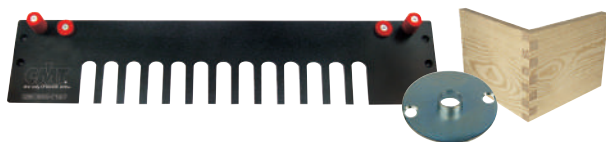

ORDER NO.	TEMPLATE LENGTH inches	DOVETAIL SIZE inches	THICKNESS inches	COLOUR
<b>CMT300-T080</b>	12	5/16	5/16 ~ 25/32	<b>blue</b>

**899.004.00** Supplied with  $\varnothing 7/16 \times 5/32$ " precision guide

To be used with CMT straight router bits:

**811.081.11** Straight bit  $\varnothing 5/16 \times 1$ " (shank  $\varnothing 1/4$ ")



## Through Dovetail Templates **CMT300-T190**

ORDER NO.	TEMPLATE LENGTH inches	DOVETAIL SIZE inches	THICKNESS inches	COLOUR
<b>CMT300-T190</b>	12	3/4	19/32 ~ 1	<b>violet</b>

**899.006.00** Supplied with  $\varnothing 7/8 \times 5/32$ " precision guide

To be used with CMT router bits:

**812.127.11** Straight bit  $\varnothing 1/2 \times 1-1/4$ " (shank  $\varnothing 1/4$ ")

**818.190.11** Dovetail bit  $\varnothing 3/4 \times 7/8$ " (shank  $\varnothing 1/4$ ")

**811.627.11** Straight bit  $\varnothing 1/2 \times 1$ " (shank  $\varnothing 1/2$ ")

**818.690.11** Dovetail bit  $\varnothing 3/4 \times 7/8$ " (shank  $\varnothing 1/2$ ")



ORDER NO.	TEMPLATE LENGTH inches	DOVETAIL SIZE inches	THICKNESS inches	COLOUR
<b>CMT300-T127</b>	12	1/2	5/16 ~ 25/32	<b>red</b>

**899.005.00** Supplied with  $\varnothing 5/8 \times 5/32$ " precision guide

To be used with CMT straight router bits:

**812.127.11** Straight bit  $\varnothing 1/2 \times 1-1/4$ " (shank  $\varnothing 1/4$ ")

**811.627.11** Straight bit  $\varnothing 1/2 \times 1$ " (shank  $\varnothing 1/2$ ")



PRECISION GUIDE FOR ROUTER:

ORDER NO.	DIAMETER inches
<b>899.003.00</b>	5/16 x 5/32
<b>899.004.00</b>	7/16 x 5/32
<b>899.005.00</b>	5/8 x 5/32
<b>899.006.00</b>	7/8 x 5/32

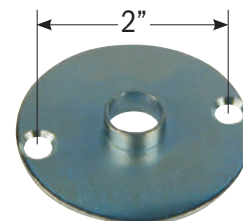

## HERE ARE A FEW OF THE BEAUTIFUL DOVETAIL JOINTS YOU CAN PRODUCE USING CMT BITS

Half blind



**CMT300 - T064**  
**CMT300 - T128** (INCLUDED with CMT300)

Box joint

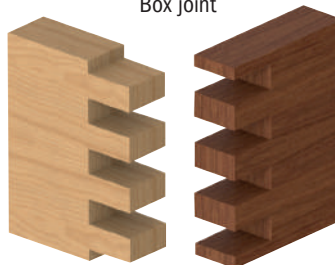

**CMT300 - T080**  
**CMT300 - T127**

Through dovetail



**CMT300 - T129**  
**CMT300 - T190**





## Flexible Template for Curved & Arched Routing

The **CMT flexible template** is easy to screw on any kind of wooden panels, MDF or chipboard for creating forms, arcs and curved elements easily and rapidly. In order to fix your **template** you can use countersunk screws, which are widely available on the market. The CMT template is made of a **highly-resistant flexible plastic**, which can be **tied in knots without any risk of ruining or reducing flexibility**. Screw your template to the edge of the panel and follow its shape and rout the border on the **guide ring**. The template is suitable for **manual feed** on routers, router tables and spindle moulders. Rout easily, safely and accurately to make multiple forms such as **arcs, curved elements and cut-out forms**. Mark the edge of your form and screw it onto a previously-positioned panel from underneath. **Two different profiles in three lengths are available**. Please notice that the smallest profile features a short radius, whereas the larger profile features a larger opening in case of flat and long curves.

ORDER NO.	DESCRIPTION	L inches
<b>TMP-1000</b>	Flexible routing template for routing 23/32" x 23/32"	L=39-3/8"
<b>TMP-1200</b>	Flexible routing template for routing 15/32" x 15/32"	L=47-1/4"
<b>TMP-2000</b>	Flexible routing template for routing 23/32" x 23/32"	L=78-3/4"

Check out the **Flexible Template** on **YouTube**

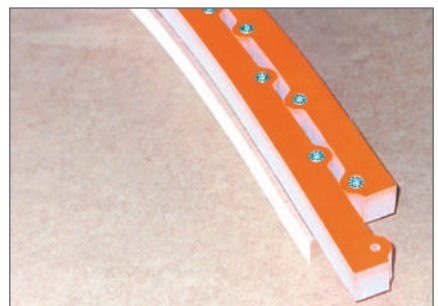
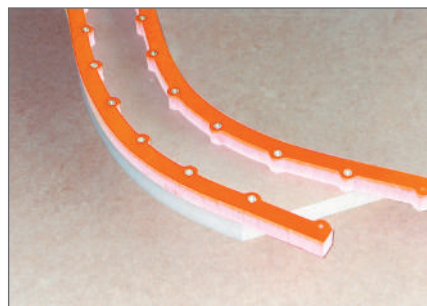
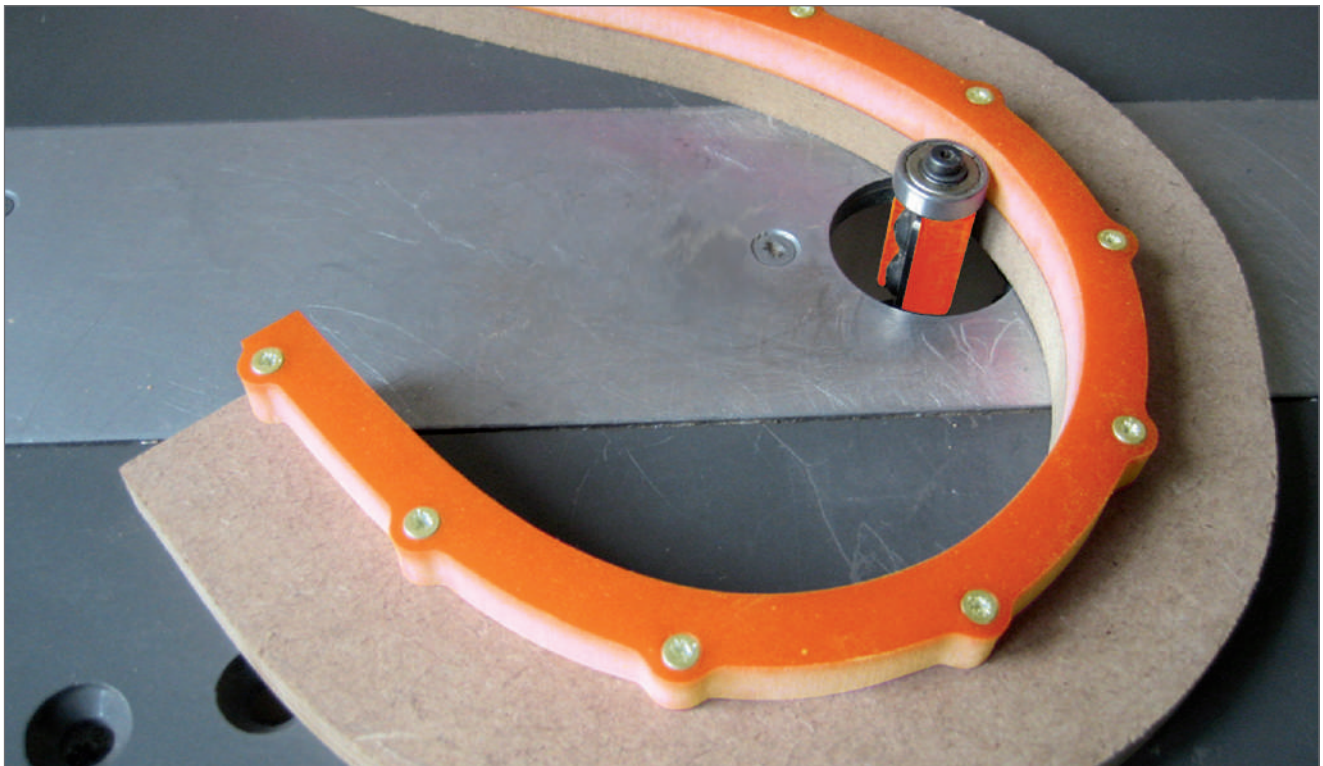



# Adjustable Precision Router Dado Jig

The perfect tool for crafting grooves, dados, and joints. Easy to use and fully adjustable. You can create dados of any size using the same router by simply increasing the number of passes you make. Sturdy construction that's built to last. Smooth rolling steel rollers are ideal for easy maneuverability and stress-free handling. Compatible with almost any router equipped with 1-3/16" (30mm) bushings or by using the Bushing Template Guides included. (bore baseplate sold separately). Guarantees clean precise dados.

**PGD-1**



Prepare your router: Install the guide bushing rings into the bore baseplate and then attach it as the base for your router. Select and insert your router bit. Prepare the Adjustable Guide Rail & Straight Edge Clamp: Position both the adjustable straight edge clamp and then the adjustable precision router dado jig onto your workpiece. Then using the adjustable thumb screws, secure it. Once assembled, ensure that the adjustable precision dado jig slides freely.



Insert your router into the center hole of the adjustable precision router dado jig.

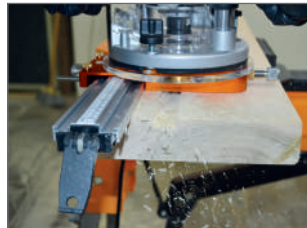

Set your cutting depth by raising or lowering the bit until desired depth is reached. Determine the starting point of the cut you wish to make by using the Dado Alignment Marks on the long sides (width) of the Adjustable Precision Router Dado Jig which indicates the outside edge of the dado cut closest to the straight edge clamp (12-10-8mm front, 1/2", 3/8", 1/4" back).



Holding onto your router in position, power on and begin making the cut by pushing forward and back on the straight edge clamp using the precision router dado jig as a guide. Makes impeccable grooves and dados along the length of your workpiece.



For creating dados that exceed router width, using the adjustable gauge, simply select the desired width on the graduated scale.

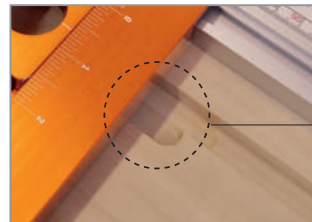

Make as many passes necessary to obtain the desired dado width.

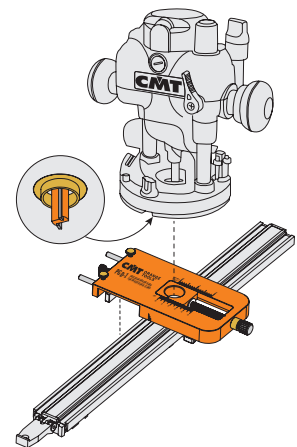
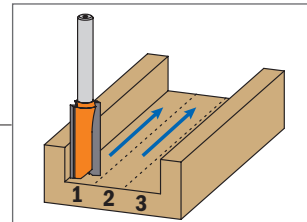

**RECOMMENDED:** for routers with 1-3/16" bushing guide or universal router base.

**RECOMMENDED:** (but not included) **PGC** Straight Edge Clamp with graduated scale (see catalog page 254)

ORDER NO.	DESCRIPTION
PGD-1	Adjustable Precision Router Dado Jig

# Professional Straight Edge Clamps

Used as a fence for your bandsaw, drill press or even as an auxiliary fence on your router table or table saw, CMT's professional straight edge clamps represent a two-in-one tool. Use them as an edge guide, or to easily clamp your boards or any object for woodworking. Available in different sizes.

**PGC**

**Features:**

- Made of extruded aluminum for easy carriage and enhanced durability.
- Light, yet more rigid than any other clamps on the market.
- Measuring scales, low-profile jaws, built-in T-tracks on the top allowing the use of accessories or jigs.
- Either single or back-to-back clamps.

ORDER NO.	DESCRIPTION
<b>PGC-24</b>	Professional Straight Edge Clamp 24"
<b>PGC-36</b>	Professional Straight Edge Clamp 36"
<b>PGC-50</b>	Professional Straight Edge Clamp 50"

Low-profile clamps allow for accurate cuts, dados and grooves. In addition they properly work as an auxiliary fence on your drill press or router table. Sturdy jaws hold your workpiece to the full length of the clamp without any side-to-side play. Back-to-back clamps with the suitable accessories also let you manage your woodworking operations with a lot of versatility. Adjustable scale and two T-tracks allow you to use many accessories.

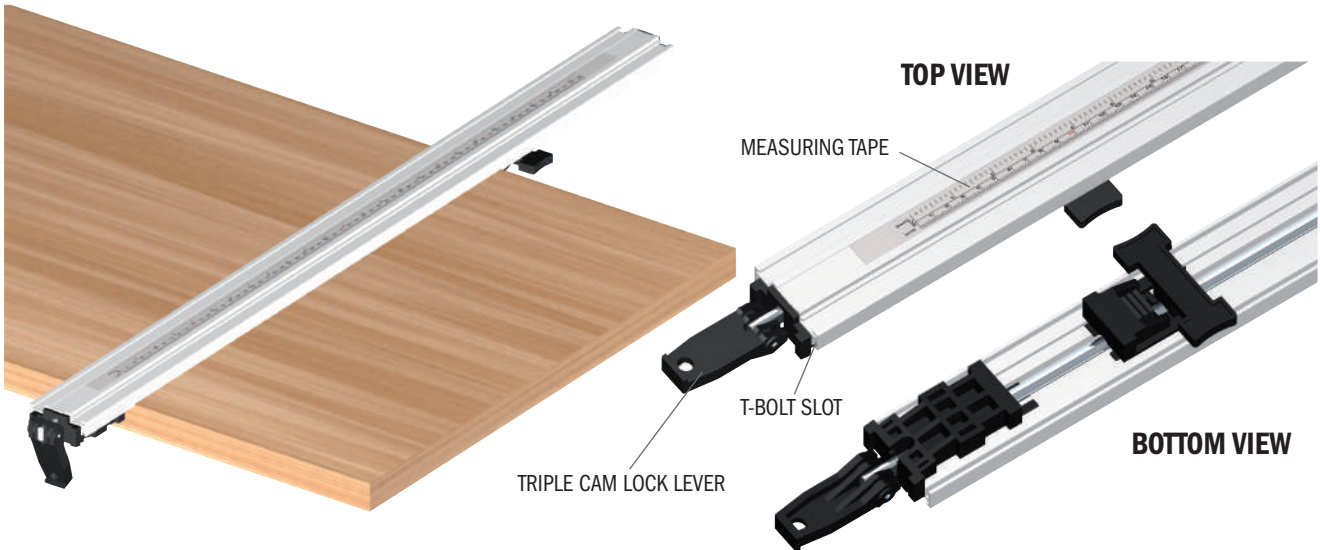

## Back-to-Back Connectors for Straight Edge Clamps (optional)

Lay two more straight edge clamps on the back of the other pair of straight edge clamps and secure them by using your back-to-back connectors. Fasten the bottom jaw pads to the table top and clamp wood with the top jaw pads. Thanks to the low profile jaws, your work surface is never obstructed. The back-to-back straight edge clamps can also be taken apart for making two separate clamps.

ORDER NO.	DESCRIPTION
<b>PGC-B2B</b>	Back to Back Connectors for straight edge clamps (8 pieces)

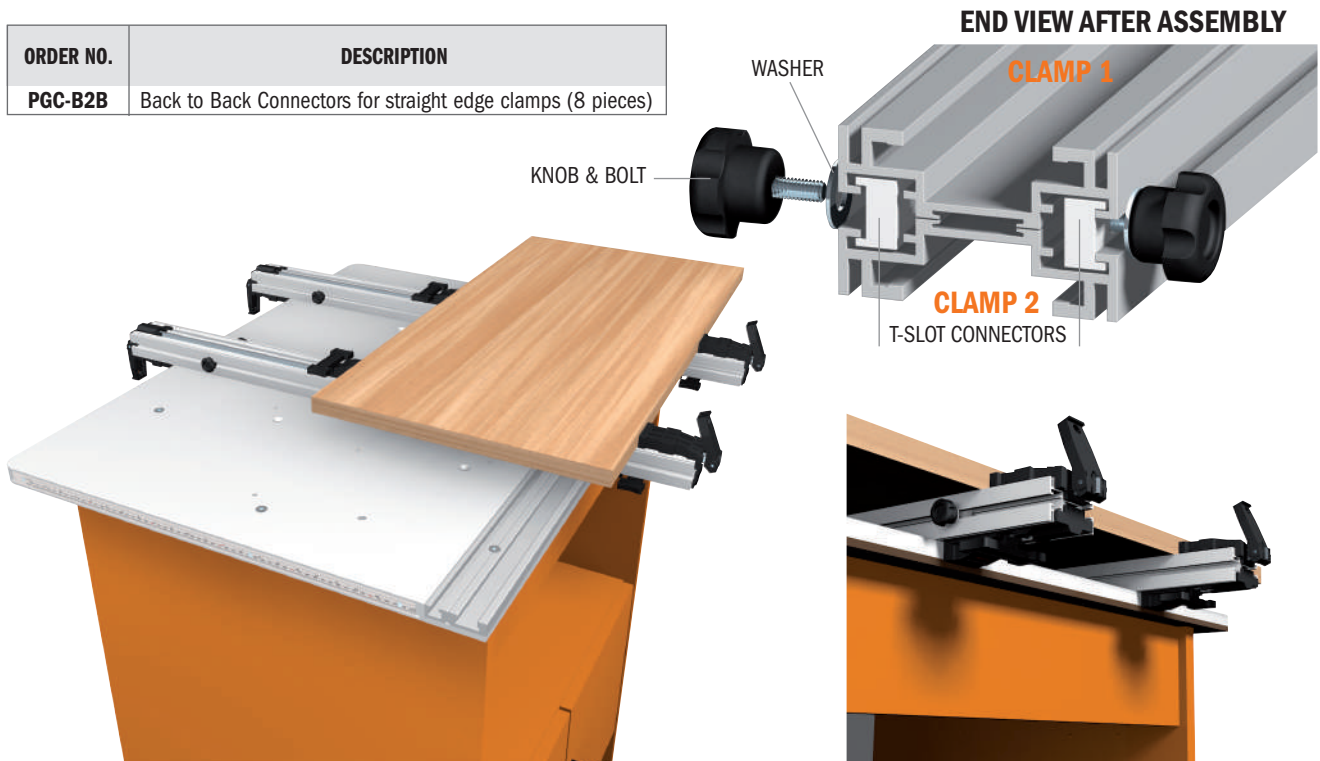



# Contour Duplicator Gauge

new

**CMT ORANGE TOOLS®**

For precision tracing of shapes, even curved, in a variety of materials. Easy sliding calipers designed to mold and duplicate any form: pipes, columns, tubing, regular and irregular walls, baseboards, crown molding, door and window framework. For use on applications such as tile, wood, wood derivatives, composite, porcelain, ceramic, vinyl, flooring for easy tracing, fitting and installation. No guesswork, no patch jobs, less waste!

**CDG-001**

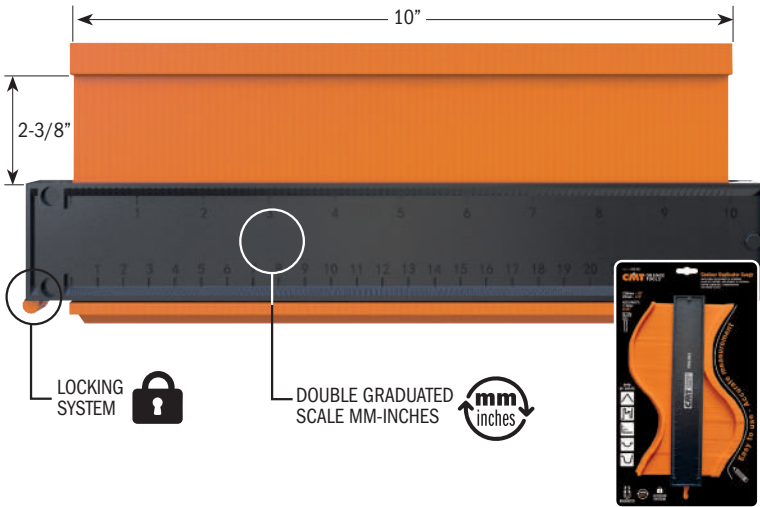

ORDER NO.	5	DESCRIPTION
CDG-001		Contour Duplicator Gauge

EASY TO USE - ACCURATE MEASUREMENT

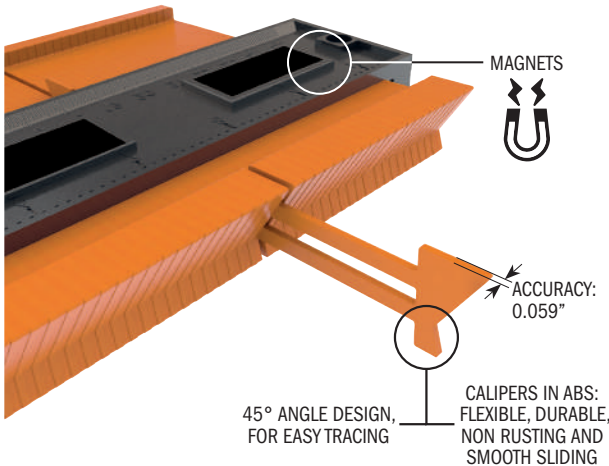
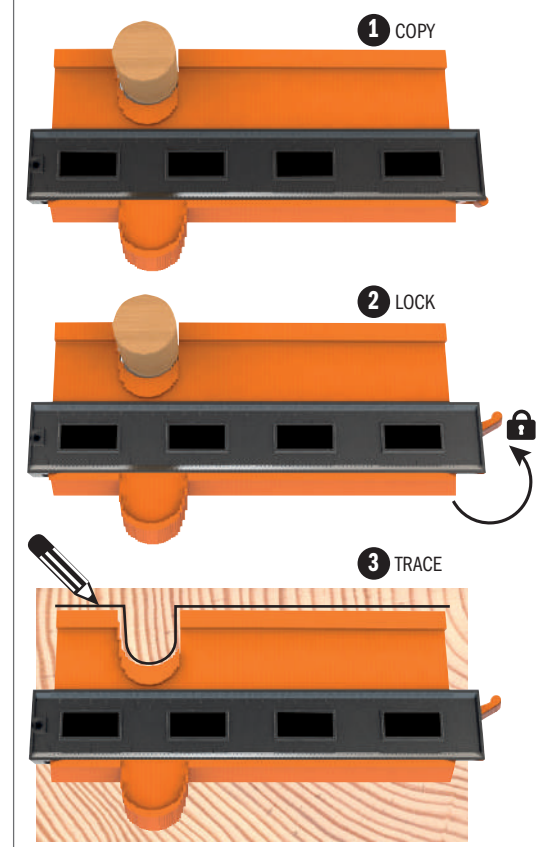

TYPE OF SHAPE

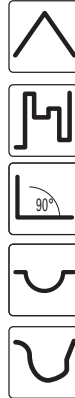

# Adjustable Corner Frame Clamps

new

CMT Adjustable Corner Frame Clamps will easily create the perfect 90° angle or handy T-joints typical in shelving, cabinets and frame applications using boards of variable thicknesses from 6 to 25.4mm. These clamps allow you to work independently, and above all, hands-free so you can glue, dry-fit, nail, screw, or square your joint securely and accurately - just like a professional. The special design allows you to immobilize the panels from the inside (hex key) and from the outside (knob) according to your project needs. Set up is easy as 1-2-3: position the clamp, twist the knob and presto! Equal pressure is instantly applied on each side of the corner and you have a perfectly squared 90° joint! Made of sturdy and durable plastic material, the clamp features a double graduated scale in mm/inches for a broad range of adjustments.

**CFC-002**

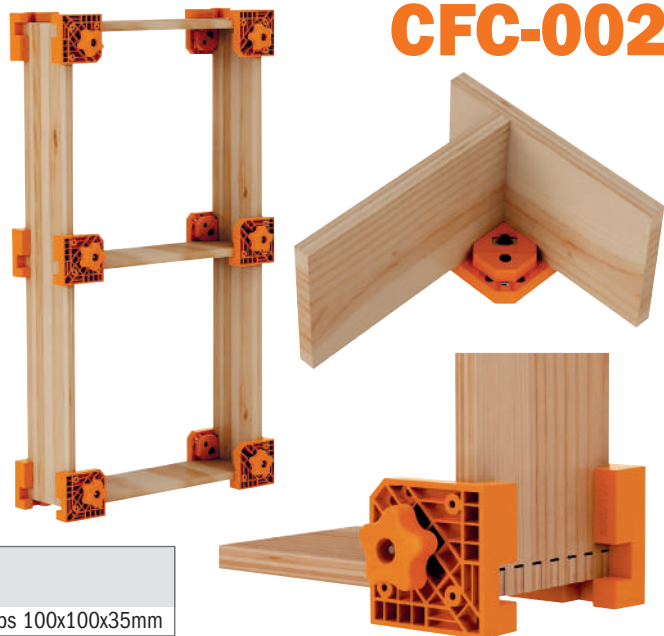

ORDER NO.	12	DESCRIPTION
CFC-002		2 pcs. Adjustable Corner Frame Clamps 100x100x35mm



# FORMULA 2050 Blade & Bit Cleaner



## SAFE, EFFECTIVE AND ENVIRONMENTALLY FRIENDLY

Professional saw shops know that clean cutting edges run cooler, cut better and last longer. That's why we had several quality blade sharpening services test our **FORMULA 2050**. The results? In a word, "Phenomenal!" Most blade and bit cleaning products work with a dissolving action, using nasty, powerful chemicals to dissolve wood residues and adhesives. Our safe and non-toxic **FORMULA 2050** penetrates the microscopic cracks in the resin and attacks the bond between it and the carbide or steel surfaces. The resin releases its grip and you simply wipe it off. **FORMULA 2050** keeps your tooling clean and helps you increase the time between sharpenings and replacement. Satisfaction guaranteed!

**998**



ORDER NO.	DESCRIPTION
998.001.01*	18 oz. (532 ml.) spray bottle
998.001.03	1 gal. (3.78 l) plastic jug
998.001.04	5 gal. (18.9 l) plastic bucket

\*12 bottles minimum and multiple

★★★★★ *This product received a five-star performance rating from "Wood Magazine®"*

- Removes pitch, resin and adhesive residue from all woodworking cutting tools (saw blades, router bits, drill bits, shaper cutters, planer blades, etc.).
- Completely non-toxic, non-flammable and certified biodegradable. Formula 2050 is a safe, earth-friendly product.
- Do not rinse after cleaning. Formula 2050 provides protection from rust and corrosion. Keeps your table saw top rust free too!
- Can be applied by spray bottle or used in ultrasonic cleaners and dip tanks.

## Organizers

### Hold up to 100 bits!

When you're working on a project you need your tools organized and close at hand. CMT's Bit Organizer is the perfect solution. This handy molded tray conveniently holds up to 100 router, drill or boring bits. By using our interchangeable bushings, the Organizer will accept any shank diameter. Order bushings from the chart below.

**03.51**



ORDER NO.	DESCRIPTION
03.51.0106	Bit organizer (without bushings)
03.51.0047A	Interchangeable bushings for 1/4" shanks (20 pieces)
03.51.0057A	Interchangeable bushings for 3/8" shanks (20 pieces)
03.51.0058A	Interchangeable bushings for 10mm shanks (20 pieces)
03.51.0049A	Interchangeable bushings for 1/2" shanks (20 pieces)

## Bench Block Set



## BBS-001

These blocks are great for holding your workpiece without any clamps. Their anti-slip surface grips both your bench top and the underside of your workpiece. Raise your work above the bench and benefit from the clearance it provides for your router bits, cutters, etc.

Length: 3" - Width: 2" - Height: 1"



ORDER NO.	DESCRIPTION
BBS-001	Bench Block Set (4pcs.) 3"x2"x1"

## 12 Corner Radius Router Template Set from 1/8" to 1"



## TMP-R12

Our useful 3-piece corner radius template set includes 5/16" thick acrylic templates that will allow you to make 12 different radii (4 per template) by using a flush trim or a pattern bit (sold separately). Included with the templates you will also find 4 alignment pins and 4 wood screws. Use the pins to align the template onto your workpiece, then use the four wood screws provided to secure it. Remove the alignment pins and use the bit to cut the corner of your workpiece to the same radius as the template.

RADIUS	
inches	mm
1/8	3
3/16	5
1/4	6
5/16	8
3/8	10
7/16	11
1/2	12
9/16	14
5/8	16
3/4	19
7/8	22
1	25

ORDER NO.	DESCRIPTION
TMP-R12	12 Corner Radius Router Template
Set contains:	12 different radii (3 templates)
	4 alignment pins
	4 wood screw

## Template Guide Kit



## CMT-TGA

A practical 7-bushing kit that will extend the possibilities of your router. For template-controlled operations such as dovetailing, stair routing, hinge butt routing, lock face routing and more general template tasks. These template guides can be used with any router featuring a 30mm (1-3/16") bore base-plate. Fits the most popular routers.

ORDER NO.	DESCRIPTION
CMT-TGA	Template Guide Kit

Set contains:

Q.TY	1	1	1	1	1	1	1	2	1
Internal diameter	5/8"	21/32"	17/32"	13/32"	11/32"	9/32"	1/4"	Lock Nut	Adapter
Outside diameter	51/64"	3/4"	5/8"	1/2"	7/16"	3/8"	5/16"	Lock Nut	
Height	9/16"	9/16"	9/16"	5/16"	5/32"	5/16"	5/32"		

## Digital Angle Gauge

# DAG-001



The digital angle gauge is a mini waterproof digital protractor that provides digital readings between  $\pm 90^\circ \times 4$  with a resolution of  $0,1^\circ$  and features auto shut off after 5 minutes. It is small enough to be carried around in your pocket and the LCD screen is easy to read. It incorporates magnets in the base for adhesion to any ferrous surface to accurately measure miter and bevel angles on miter saws, saw benches, etc.

- Accurately sets saw blade bevel angle, works great for miter saws and table saws.
- Automatic LCD backlight
- Large display for easy digital reading
- Measurements in absolute or relative mode
- Angles displayed in degrees
- Automatic digit inversion for overhead measurements
- Set to ZERO
- Magnetic base
- Case included
- Instruction manual

### TECHNICAL DETAILS:

- Range:  $\pm 90^\circ \times 4$
- Resolution:  $0,1^\circ$
- Battery: **Included**
- Battery Type: AAA-1.5V; Alkaline
- Dimensions: 2-3/8" x 2-3/8" x 1-1/8" (60x60x28mm)

ORDER NO.	DESCRIPTION
DAG-001	Digital Angle Gauge

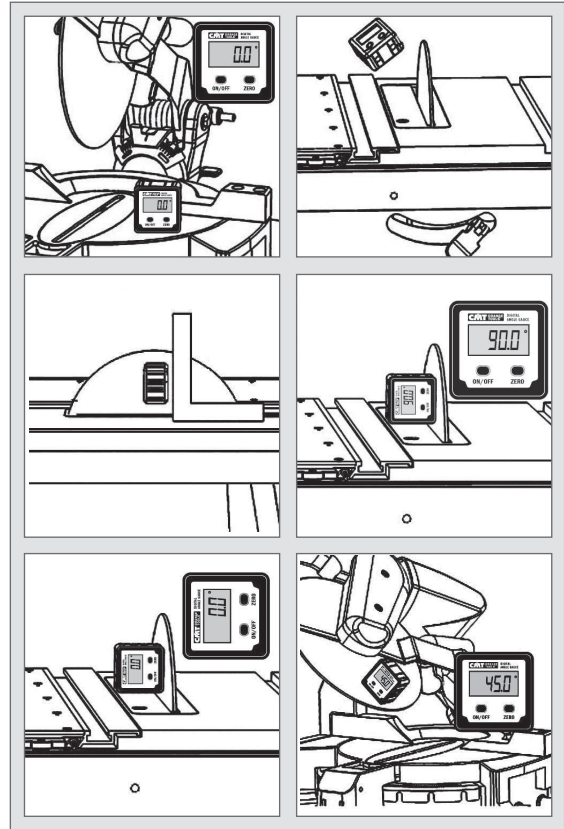

Watch the video on **YouTube**

## Digital Angle Finder

# DAF-001



This digital angle finder is a multi-functional tool for many measuring applications. Easy to operate, the base unit carries the electronics featuring clear detailed LCD display, a pair of levelling vials and a pivoting measuring arm. When the arm is extended, the angle created with the base is indicated clearly on digital read-out to the nearest  $0,05^\circ$ . The measuring range is  $0 - 360^\circ$ . The vials allow both vertical and horizontal variations to be accurately measured. Other features include a lock function to prevent the last measurement being lost, a low battery indicator and automatic shut off function. Robust yet lightweight, this tool is very versatile.

ORDER NO.	DESCRIPTION
DAF-001	Digital Angle Finder

Watch the video on **YouTube**

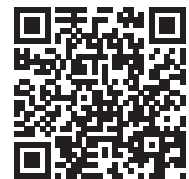

- Easy and simple to use.
- Calculates angles in seconds.
- Large detailed LCD display.
- Robust, lightweight aluminium construction.
- Instruction manual.

### TECHNICAL DETAILS:

- Range:  $0-360^\circ$
- Resolution:  $0,05^\circ$
- Battery: **Included**
- Battery Type: CR2032-3V; Lithium Button Cell
- Dimensions: 10-1/4" x 2" x 1" (260x50x25mm)

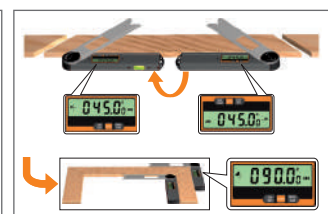
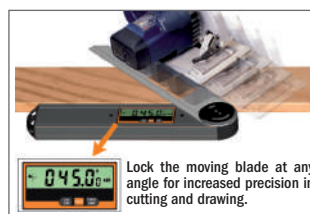
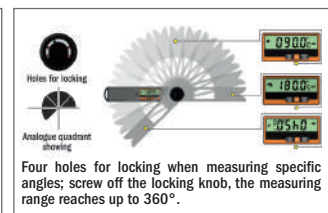
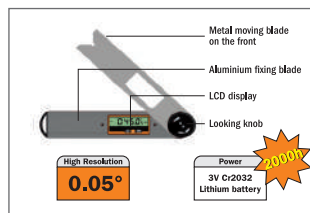



# Digital Height Gauge

## DHG-001



- Precise measurements for router bits, saw blades, band saw blades, cutter heads, drill bits, holes depth.
- Measuring ruler with Metric/Imperial scale and locking screw.
- Horizontal & vertical measuring.
- Digital easy-to-read display.
- Self-standing with magnets, for setting cutting depth on router tables and low profiles for backfence adjustment.
- Instruction manual.



**TECHNICAL DETAILS:**

- Measuring range: Scale: 0~3" (0~80mm); Needle: 0~2" (0~50mm)
- Wide opening: 2.5" (60mm)
- Resolution: 0.002" (0.05mm)
- Accuracy: ±0.004" (±0.1mm)
- Battery: **Included**
- Battery Type: CR2032-3V; Lithium Button Cell

ORDER NO.		DESCRIPTION
DHG-001	10	Digital height gauge

PLACE YOUR GAUGE ON A FLAT SURFACE AND SET TO "0" ON THE DISPLAY.

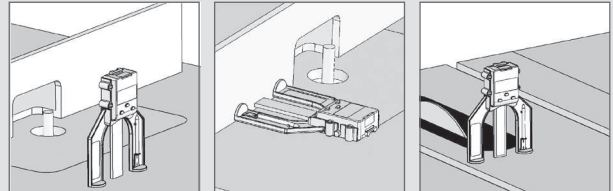

POSITION YOUR GAUGE ON THE DESIRED POSITION.

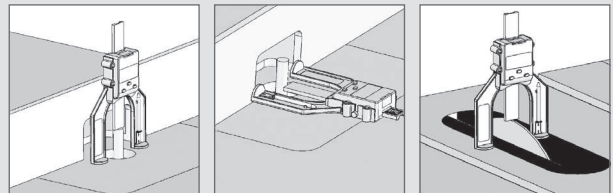

INSERT NEEDLE AND SET TO "0".

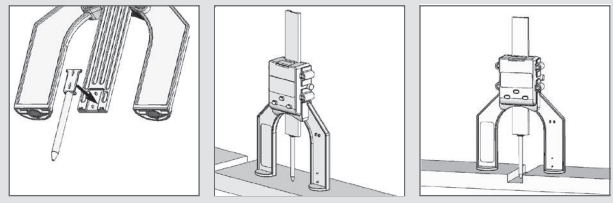

# Digital Moisture Meter

## DMM-001



Ideal for use in woodworking, building construction and agricultural industries. The **DMM-001** is also an invaluable tool in the restoration field. Ideal for locating moisture in carpets and sub-flooring.

Ultra-sensitive Digital Moisture Meter easily detects hidden leaks in wood, concrete, plaster and carpet. Providing accurate moisture level readings make this tool great for new home inspections, locating roof leaks or even selecting dry lumber at the yard. Display will show the moisture content in Percent Moisture Content directly.

**TECHNICAL DETAILS:**

- Moisture measuring range: 5~50% (in wood); 1.5~33% (in building material)
- Measuring accuracy: ±2%
- Backlight shut off: In about 15 seconds
- Auto power off: After 3 minutes idle
- Battery: **Included**
- Battery Type: 9V Battery Block (6F22 or 6LR6); Alkaline
- Low battery indicator: <7V
- Working current: <25mA
- Working temperature: 32°F~122°F
- Working humidity: <90%RH non-condensing
- Storage: -4°F~140°F ≤85% (without battery)
- Dimensions: 5-11/16" x 2-9/16" x 1" (145x65x25mm)
- Weight: About 3oz (without battery)

- Measures moisture content by detecting a material's electrical resistivity using two pins.
- Measurement output is displayed on a practical LCD screen.
- Instruction manual.



Calibration holes

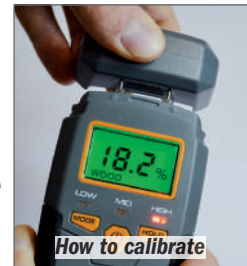

How to calibrate



ORDER NO.		DESCRIPTION
DMM-001	5	Digital Moisture Meter

Spare parts DMM-001/1 Set 2 Pin for DMM-001



# Bowl & Tray System

**BTS-001**

The CMT Bowl and Tray Kit, **BTS-001**, provides a fun and easy way for you to make divided bowls and trays in your shop. No lathe? No problem. This bowl making technique uses a router and CMT's unique Bowl and Tray router bit. The resulting bowls and trays are beautiful, and will leave your friends saying, "How did you make this?" What great gifts! The templates will withstand a lifetime of use, and can be used to make more than just one style of bowl or tray. The collet extension, used to make extra deep bowls, is also useful whenever your general woodworking requires extra deep cuts.



ORDER NO.	DESCRIPTION
<b>BTS-001</b> ■	Bowl and Tray System
<i>Set contains</i>	
<b>851.502.11B</b>	Router Bit
<b>796.001.00</b>	Router Collet Extension
<b>TMP-011</b>	MDF Template nr. 1
<b>TMP-012</b>	MDF Template nr. 2

■ *Until stock last*



Watch the video on



*Trace the templates onto the bowl blank.*



*Rough out the interior using a drill press and a 2" Forstner bit.*



*Rout the interior to final shape using the bowl and tray router bit and collet extension.*



*Bandsaw the exterior to final shape.*

## RCS



The 3D Router Carver System is protected by U.S. Patent No. 5,146,965

### Exclusively from your CMT distributor

Turn your router into a remarkable carving tool. It's fast, easy, and a whole lot of fun!

Who says that intricate woodcarving requires an artist's touch? Thanks to the patented 3D Router Carver System, anyone with a 1/2" collet plunge router can create any of the beautiful designs shown on these pages in just minutes. Decorate doors, drawers, cabinets, furniture or just about any flat wooden surface with one or more of these designs.

How does it work? The secret is in the 3D Router Carver Bit and the way that bit interacts with the carving templates. The V-Groove router bit is enclosed in a 45° cone-shaped guide. You rout with the plunge mechanism of your router unlocked, allowing the bit to move up or down as the router moves forward. As the slot in the template get wider, the bit moves down, producing a wider, deeper V-groove. As the slot gets narrower, the bit moves up, and the groove gets narrower and shallower. It sounds simple, and it is! (that's why the system is patented in the USA and around the world).

Please see the illustrations below for more details on the carving technique. You'll receive complete instructions with your 3D Carver templates. For an informative visual demonstration, check out the 3D Router Carver video online.

What do you need to get started?

- The 3D Router Carver Bit
- The Carver Template of your choice
- The Holding Frame to match your template (these are listed in the charts with the templates)
- Your 1/2" collet plunge router

(Note: Be sure the opening in the base of your router is at least 1-7/8" in diameter. If it isn't, you'll need to make a sub-base to accept the large diameter of the 3D Carver bit.)

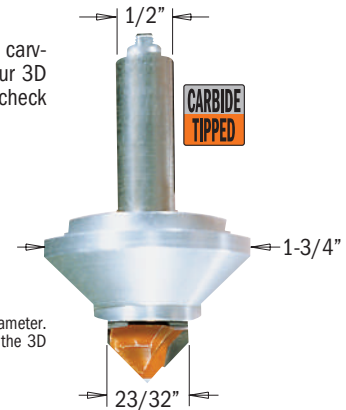

### Complete Classical Starter Set

The ideal introduction to the world of router carving. You'll get everything you need to make two of the most popular designs: the Classical Cabinet Door and Classical Drawer, plus two Holding Frames, a 3D Carver Router Bit, all at a special price! Best of all, the Holding Frames will work with any of our Cabinet Door or Drawer Templates, so you'll be able to add new designs at a minimal cost!

ORDER NO.	DESCRIPTION
RCS-BIT	3D router carver carbide bit
RCS-CUT	3D router spare carbide bit
RCS-ST5	3D router carver starter set



Classical Cabinet Door, #RCS-302

Classical Drawer, #RCS-502



**1.** Clamp or tack the holding frame to your workpiece

### HERE'S HOW IT WORKS:

**3.** Plunge the bit into a wide part of the slot and rout with the router's plunge mechanism unlocked.

**4.** With the frame still in place, flip the template & rout again. Some templates will be routed 2 to 4 times, depending on the complexity of the design.

**2.** Drop the template into the holding frame

Allow the plunge mechanism to move up and down as you advance. Wider template slots allow wider, deeper grooves. Narrower slots produce shallower grooves.

**5.** Remove the frame and you're finished!



## CABINET DOOR & PANEL CARVINGS



## RCS

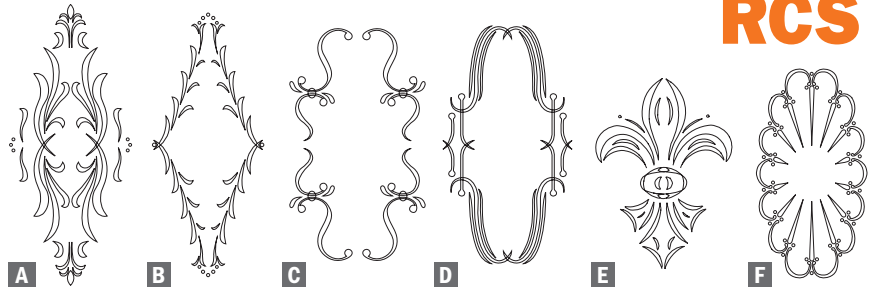

These designs are ideal for the doors or panels of cabinets, entertainment centers, fireplace surrounds or almost any flat surface. See the designs below for complementary patterns for drawers, rails and corners. Approximate carving time 5 minutes.

ORDER NO.	DESCRIPTION	CARVING DIMENSIONS inches	NO. OF TEMPLATES
RCS-302	Classical cabinet door - A	17-1/4 x 7-1/4	2
RCS-304	Florentine cabinet door - B	16-1/4 x 6-5/8	2
RCS-305	Cascade cabinet door - C	14-3/8 x 8-1/4	1
RCS-306	Roma cabinet door - D	14-3/4 x 7-7/8	1
RCS-805	Fleur-de Lys door - E	9-7/8 x 7	4
RCS-806	Spanish fan template - F	15 x 7-7/8	2
RCS-003	Cabinet door holding frame		

## DRAWER & FURNITURE CARVINGS

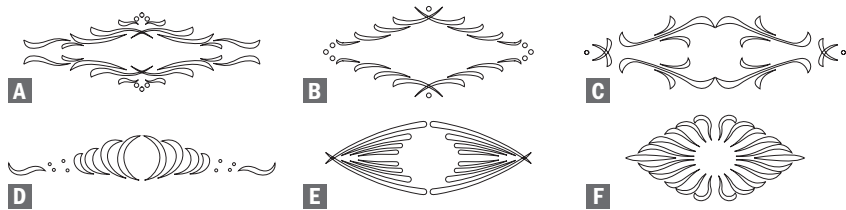

Originally intended for drawer fronts, these designs are great for lots of other projects: small doors, side panels of cabinets, furniture and more. For door and drawer combinations, match the style of the door designs above. Approx. carving time 4 minutes.

ORDER NO.	DESCRIPTION	CARVING DIMENSIONS inches	NO. OF TEMPLATES
RCS-502	Classical drawer - A	8-1/4 x 2-3/4	2
RCS-504	Florentine drawer - B	7-5/8 x 3-3/8	2
RCS-505	Cascade drawer - C	9-7/8 x 2-1/2	1
RCS-506	Folklore drawer - D	9-7/8 x 1-1/2	2
RCS-507	Roma drawer - E	7-1/2 x 2-1/2	2
RCS-510	Blaze drawer - F	9-7/8 x 4-3/8	2
RCS-005	Drawer holding frame		

## PANEL & RAIL CARVINGS

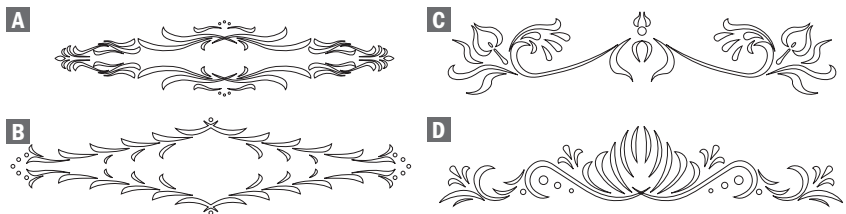

With a long, horizontal shape, these designs are perfect for door rails, headboards, cabinet face frames and valences. Approximate carving time 4 minutes.

**TIP:** Many carvings, like the Florentine Rail, are enhanced with the addition of a Rosette.



ORDER NO.	DESCRIPTION	CARVING DIMENSIONS inches	NO. OF TEMPLATES
RCS-402	Classical rail - A	21-5/8 x 4-3/4	2
RCS-404	Florentine rail - B	21-5/8 x 5	2
RCS-405	Cascade rail - C	20-7/8 x 4-3/8	3
RCS-406	Folklore rail - D	21-5/8 x 4-3/8	3
RCS-004	Rail holding frame		

## SOUTHWESTERN CARVING DESIGNS

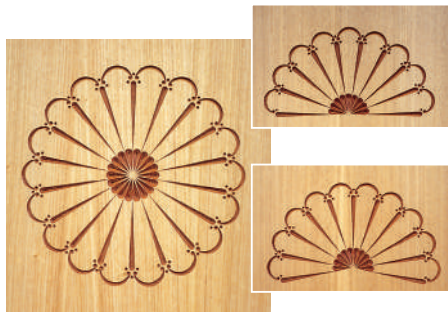

These popular Southwestern designs are actually several shapes in one. Both sizes can be routed as circular carvings, or use only portions of the template to suit your project.

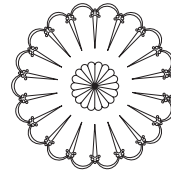

Rout the complete Spanish Fan Design or make partial rosettes

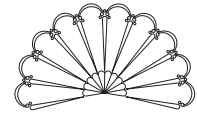
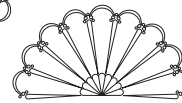

## RCS

ORDER NO.	DESCRIPTION	CARVING DIMENSIONS inches	NO. OF TEMPLATES
<b>RCS-801</b>	Large spanish fan	15-3/4	1
<b>RCS-802</b>	Small spanish fan	7-7/8	1
<b>RCS-007</b>	Rosette holding frame		

## ROSETTE CARVINGS



You get two templates for the price of one with these designs! Each item includes templates for two sizes of Rosette. For use with the Rosette Frame sold above, or for use the large rosettes with the cabinet door frame or small rosettes with rail frame.

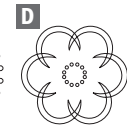
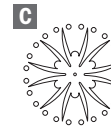
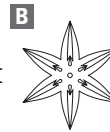
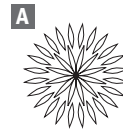

ORDER NO.	DESCRIPTION	CARVING DIMENSIONS inches	NO. OF TEMPLATES
<b>RCS-701</b>	Rosette #1 & #5 - A	3-3/8 & 2-5/8	2 & 2
<b>RCS-702</b>	Rosette #2 & #6 - B	3-1/2 & 2-3/4	1 & 1
<b>RCS-703</b>	Rosette #3 & #7 - C	3-1/4 & 2-1/2	1 & 1
<b>RCS-704</b>	Rosette #4 & #8 - D	3-1/8 & 2-7/16	1 & 1
<b>RCS-007</b>	Rosette holding frame		

**Just for fun:  
DESIGNS FOR  
EVERY ANIMAL  
LOVER!**

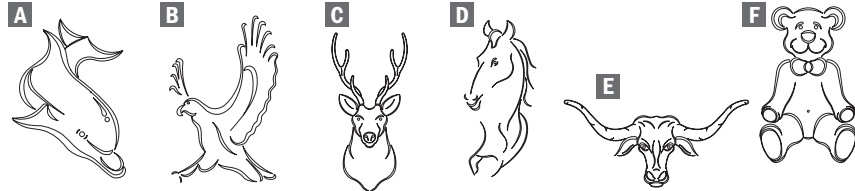

Your imagination will be your guide on these neat designs. Furniture or decorations for the kids, paneling for the den or rec room, a gift for the sportsman - who knows?

ORDER NO.	DESCRIPTION	CARVING DIMENSIONS inches	NO. OF TEMPLATES
<b>RCS-803</b>	Dolphin - A	7-7/8 x 11-7/16	4
<b>RCS-804</b>	Eagle - B	7 x 11-3/4	4
<b>RCS-901</b>	Deer - C	15-1/2 x 7-1/2	4
<b>RCS-902</b>	Horse - D	17-1/2 x 8	3
<b>RCS-904</b>	Longhorn - E	16-1/2 x 7-5/8	4
<b>RCS-906</b>	Teddy bear - F	15-1/2 x 8	3
<b>RCS-003</b>	Cabinet door holding frame		

## CORNER & SMALL DECORATION CARVING DESIGNS

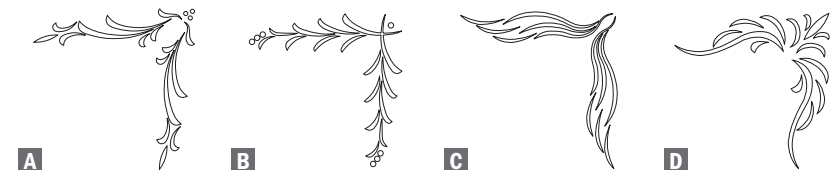

ORDER NO.	DESCRIPTION	CARVING DIMENSIONS inches	NO. OF TEMPLATES
<b>RCS-602</b>	Classical corner - A	6-1/8 x 1-9/16	3
<b>RCS-604</b>	Florentine corner - B	4-3/4 x 1-1/8	3
<b>RCS-605</b>	Cascade corner - C	7-1/2 x 1-9/16	3
<b>RCS-606</b>	Folklore corner - D	6 x 1-3/4	3
<b>RCS-006</b>	Corner holding frame		



# Interchangeable Torque Wrench 20~200 Nm

new

**CMT ORANGE TOOLS®**

The Interchangeable Torque Wrench comes complete with a sturdy protective case to store and keep tools safe, an instruction manual, and calibration certification(unique for each instrument) according to DIN ISO 6789 & ASME B107.300-2010.

**TW-200**



Scale Adjuster

Torque Scale (Nm/Lbt-ft)

Interchangeable Head  
S=14x18mm

**Optional**



ORDER NO.	S mm		DESCRIPTION
<b>TW-200</b>	14x18	12	Interchangeable Torque Wrench 20~200 Nm
<b>TW-2836</b>	14x18	1	Hook Head Insert Ø=28-36mm (ER16 & ER20)
<b>TW-4045</b>	14x18	1	Hook Head Insert Ø=40-45mm (ER25)
<b>TW-5055</b>	14x18	1	Hook Head Insert Ø=50-55mm (ER32)
<b>TW-5862</b>	14x18	1	Hook Head Insert Ø=58-62mm (ER40 & EOC25)
<b>TW-8001</b>	14x18	1	Hook Head Insert Ø=80mm (Kinetic Dust Extractor 992)
<b>TW-1001</b>	14x18	1	Hook Head Insert Ø=100mm (Kinetic Dust Extractor 992)
<b>TW-A095</b>	14x18	5	Push Ratchet Insert S2=3/8"
<b>TW-A127</b>	14x18	5	Push Ratchet Insert S2=1/2"
<b>TW-A912</b>	14x18	50	Adapter Insert S2=9x12mm

To download this user manual in a different language, visit [www.cmtorangetools.com](http://www.cmtorangetools.com)

**Applications**



The Interchangeable Torque Wrench is versatile enough for use in many fields, but we recommend it for the tightening of CMT chucks.

**TECHNICAL DETAILS:**

- Range..... 20~200 Nm (10-150 lbf-ft)
- Resolution ..... 1 Nm
- Tolerance..... ±4%
- Length..... 500mm (19.7")
- Weight..... 1.15Kg. (40.6oz)
- Automatic quick-release, audible and palpable click, when selected torque is reached
- Right-handed (CW)

**TORQUE SUGGESTED\***

CHUCK/COLLET	Nm	Lbf-ft
ER16	57	42
ER20	80	59
ER25	104	77
ER32	135	100
ER40	176	130
EOC25	122	90

\* Suggested tightening torque for CMT Chuck/Collet

## Carpenter Pencil & Ink Pen

An easy-grip shape and larger rectangular surface area means this pencil won't roll away or slip from your hands. The non-round core makes highly legible thick or thin lines. Perfect for high precision tracing and marking virtually any surface. Easy to erase. Strong break-resistance lead center withstands rough handling as well as the rigours and extreme conditions of the construction environment.

A classic black ink pen with great features: ball point style for smooth fluid writing on the job, even on an angle, easy click open and close, sturdy metal pocket clip to keep it in place and our bright orange colour for better visibility.



**PCL-1**



**PCL-2**

new

ORDER NO.		DESCRIPTION
<b>PCL-1</b>	50	Carpenter Pencil
<b>PCL-2</b>	50	CMT Ink Pen

# Adjustable Torque Screwdriver Set 1~6 Nm

**new**

**CMT ORANGE TOOLS®**



The Adjustable Torque Screwdriver set includes 20 types of inserts and provides a sturdy protective case to store and keep tools safe. In addition to the instruction manual, inside you'll find the calibration certificate (unique for each instrument) according to DIN ISO 6789 & ASME B107.300-2010.

**TW-006**



Female Hex Drive 1/4" (6.35mm)

Graduated Torque Scale Nm  
Unlocking/Locking Nut

**Set contains**

- Torque screwdriver
  - 20 types of inserts:
  - Plastic case
  - Instruction manual
  - Calibration certificate
- ⊕ 0-1-2-3 (n°4 pcs)
  - ⊖ 8-9-15-20-25 (n°5 pcs)
  - ★ 3-4-5-6 (n°4 pcs)
  - ⊕ 1.5-2-3-4-5-6 (n°6 pcs)
  - + Square Adaptor 1/4" (6.35mm), n°1 pc

**TECHNICAL DETAILS:**

- Range..... 1~6 Nm
- Resolution ..... 0.1 Nm
- Tolerance..... ±6%
- Length..... 195mm (7.7")
- Weight..... 335gr. (11.8oz)
- Automatic quick-release, audible and palpable click, when selected torque is reached
- Automatic reset after 90°
- Right-handed (CW)

**TORQUE SUGGESTED\***

THREAD	Nm
M2,5	1,0
M3	1,2
1/8"	1,4
M3,5	1,8
M4	2,7
M5	5,3

\* Suggested tightening torque for CMT screws (Class 8.8)



To download this user manual in a different language, visit [www.cmtorangetools.com](http://www.cmtorangetools.com)

ORDER NO.	DESCRIPTION
TW-006	Adjustable torque screwdriver set 1~6 Nm

**Applications**

The Adjustable Torque Screwdriver is versatile enough for use in many fields, but we recommend it for the tightening or fastening of CMT bits and cutters heads with interchangeable knives.

Some CMT products may require the use of an extension, which is not included in the TW-006 set.

# CMT Professional Tool Bag

- Top zipped design and wide opening for accessing tools easily.
- Sturdy material and hard rubber bottom are resistant to rough handling and protects the contents from hard falls.
- 6 interior pockets, 12 exterior pockets.
- Ideal for storing and transporting hand tools as well as other medium sized items & accessories.

**BAG-001**

Material: Polyester 600D with 3mm EPE foam  
Dimensions: 400x200x250mm

ORDER NO.	DESCRIPTION
BAG-001	CMT Professional Tool Bag



5 rubber studs at bottom



## Laminate/Veneer Cutter



A very useful hand tool for clean, splinter-free cuts on laminates and veneer with no waste. Place your material into the fence provided and have the cutter run along the edge of the panel. The two opposing steel-made circular cutting blades mounted on roller bearings will trace the cutting line. Use the micrometer knob on the top of the tool to set the cutting thickness, or adjust the strip width by using the metric/inch scale provided. Loosen the lock knob on the scale, move the metal bracket which holds the fence and tighten the lock knob again on the desired cutting width.

**DET-003**

**TECHNICAL FEATURES:**

- Cutting width: 15/32" ~ 4-21/64".
- Cutting depth: 0 ~ 5/64".
- Weight: 2.65 lbs.

ORDER NO.	DESCRIPTION
DET-003	Laminate/Veneered cutter

Spare parts: **DET-003K** Pair of cutters right-left for DET-003

## Edge Banding End Trimmer

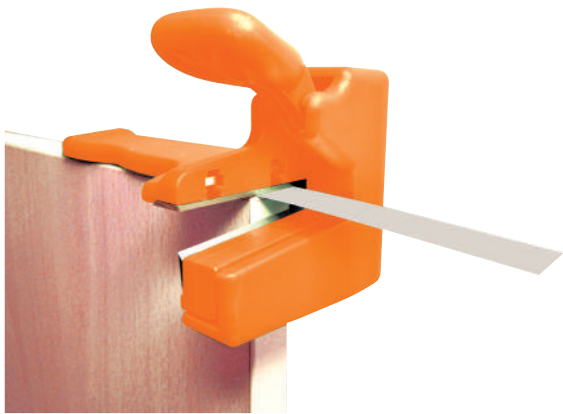

An indispensable tool for easy and safe end trimming after edge banding. Position the tool on the banding, press the handle down to operate the blade in a shearing action. The cutting knives are interchangeable, so when the cutting knife becomes dull, you can simply replace it with the anvil knife and double the lifespan. For cutting banding up to 1/64" thick with a maximum cutting width of 2-1/8". This tool can also be paired up with our double edge trimmer **DET-001**. We recommend using our edge banding end trimmer **DET-002** before using our double-edge trimmer **DET-001**.

**DET-002**

ORDER NO.	DESCRIPTION
DET-002	Edge Banding End Trimmer

Spare parts: **DET-002K** 2-Pcs replacement blade set 55x13x1.5mm

## Double-Edge Trimmer



Attach this trimmer to your workpiece, press both ends against the board for a cutting range between 13mm (1/2") and 25mm (1"), move the trimmer in the correct direction indicated by the arrow. This will cut on both sides easily. The first cutter will cut straight, the second one can be adjusted for a tapering cut. Both cutters are made from high-quality hardened steel and can be easily replaced when worn out.



**DET-001**

ORDER NO.	DESCRIPTION
DET-001	Double-Edge Trimmer

Spare parts: **DET-001K** Spare knives for double-edge trimmer

## Latex Coated Gloves

These protective gloves are not only comfortable but offer high elasticity, impressive grip as well as good resistance to abrasion, perforation and tears. CE Certified and Mechanical Hazards EN 388:2016 compliant (2132X). Available in three sizes!

ORDER NO.	DESCRIPTION	DESCRIPTION
GLA-08M	25	Latex coated gloves M (8) 
GLA-09L	25	Latex coated gloves L (9) 
GLA-10XL	25	Latex coated gloves XL (10) 





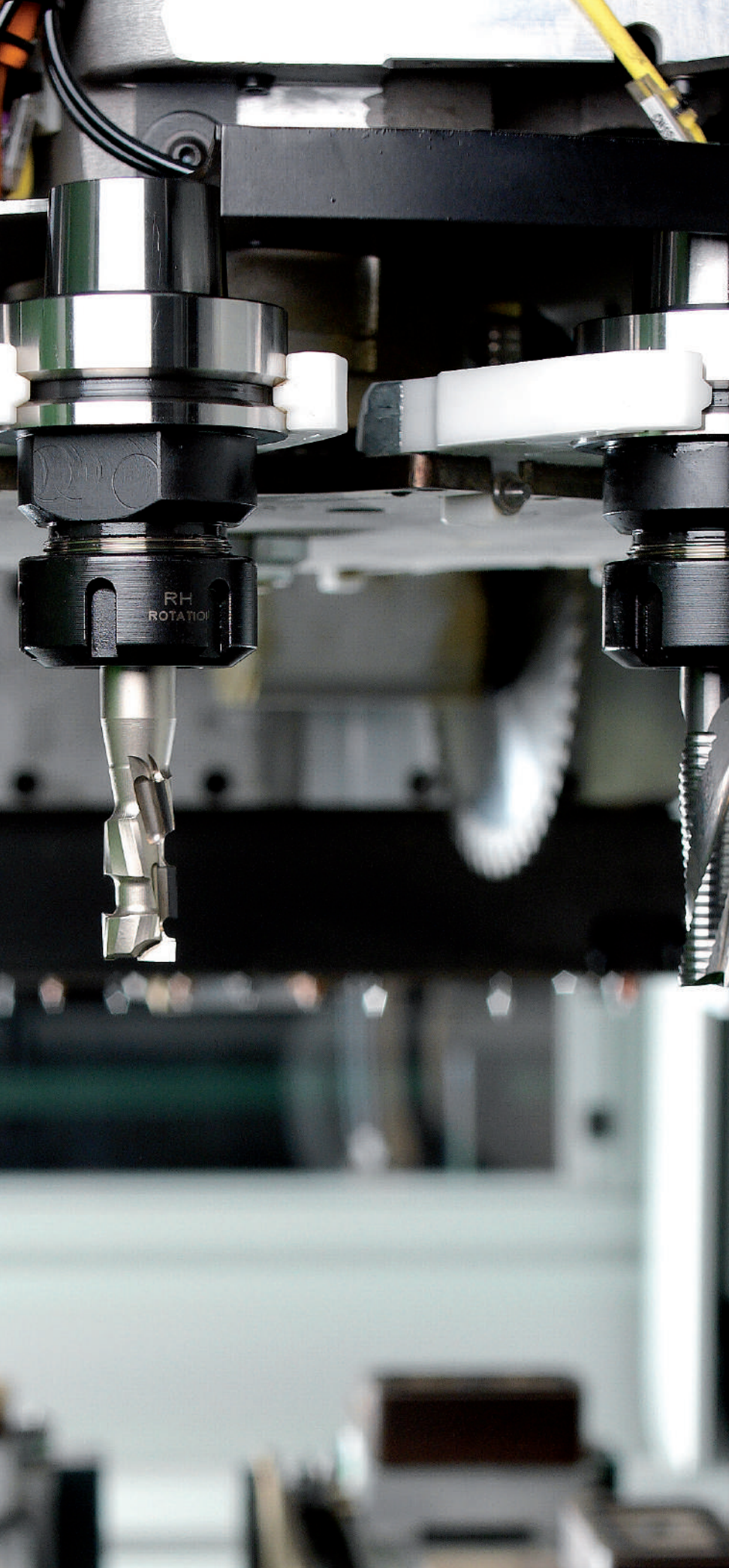

# CNC ROUTER BITS & CHUCKS

<b>PRODUCTS</b>	<b>PAGE</b>
Kinetic Dust Extractor	270
Universal Assembly Support for Chucks	271
CNC Chucks	271-272
Precision Collets	273
HSK Chucks for Grooving Blades	274
Solid Carbide Spiral Bits	275~281
Diamond Compression Bits	282
CNC Cutters with Insert Carbide	282~286





# Kinetic Dust Extractor



**992** Removes MDF & Chipboard dust from the workpiece

ORDER NO.		D		DESCRIPTION
		inches	mm	
992.081.ER20	1	3-5/32	80	Kinetic Dust Extractor for chucks with ER20
992.081.ER25	1	3-5/32	80	Kinetic Dust Extractor for chucks with ER25
992.101.EOC25	1	3-15/16	100	Kinetic Dust Extractor for chucks with DIN6388/EOC25 collets
992.101.ER32	1	3-15/16	100	Kinetic Dust Extractor for chucks with ER32 collets
992.101.ER40	1	3-15/16	100	Kinetic Dust Extractor for chucks with ER40 collets

Spare parts: **991.285.00** C-Spanner 80-90mm (ER20/ER25)  
**991.284.00** C-Spanner 95-100mm (EOC25/ER32/ER40)

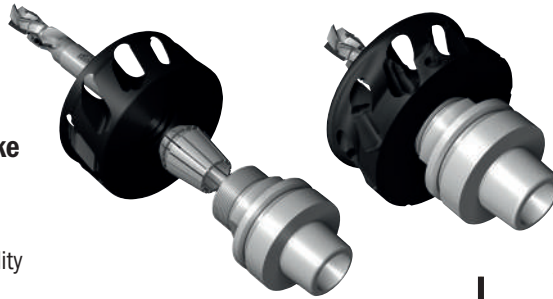

## EASY TO USE!

### Installation and removal just like a clamping nut

- Better health & safety on the worksite
- Better air quality on the worksite
- Improves tool performance & cut quality
- Longer tool life & reduced labor costs
- Recommended for Nesting and routing operations
- No wasted time throughout operation
- Replaces the standard clamping nut
- Suitable for any collet chucks with standard router bits
- Available for ER32 - ER40 - EOC25 (DIN6388) collets
- Tough ceramic coating offers anti-corrosion, anti-friction and anti-static protection.
- Tool body in light alloy
- Lightweight and quiet
- Performs even at low RPM: from 6,000 up to 20,000 rpm
- Materials: chipboard, coated chipboard, MDF, CORIAN®, plasterboard, OSB, HPL.

### SAFETY TIPS:

The **TW-200** Torque Wrench is recommended for the proper fastening of clamping nuts (see page 266)

Always use vacuum system.

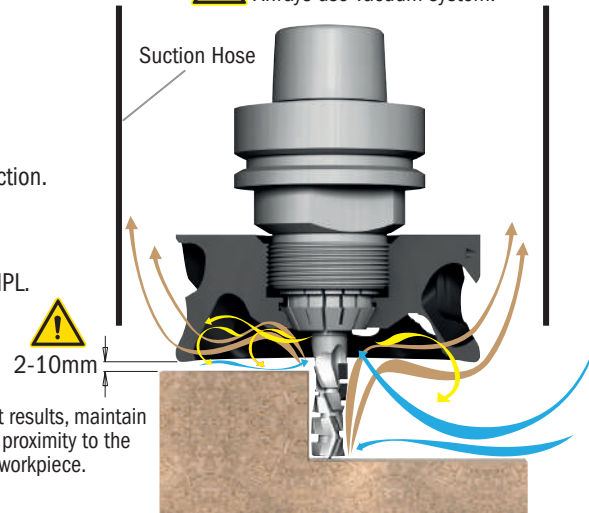

Download Instruction



Watch the video on **YouTube**

### Working **WITHOUT** Kinetic Dust Extractor



### Working **WITH** Kinetic Dust Extractor



## HSK-63F Chuck for "ER32" Precision Collets

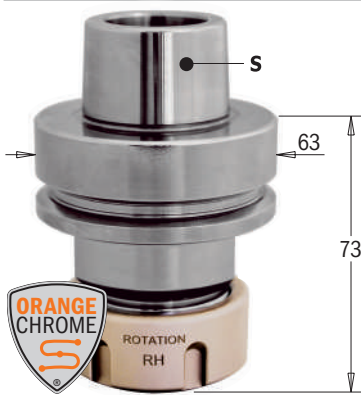

**183.300** X-TREME



ORDER NO. Right-hand rotation	ORDER NO. Left-hand rotation		S	TO BE USED WITH COLLET	NOTE
<b>183.300.01</b>	<b>183.300.02</b>		HSK-63F	ER32	Clamping nut without bearing
<b>183.300.11*</b>		<b>1</b>	HSK-63F	ER32	Clamping nut with bearing

Optional: 990.118.00 M6x10mm screw

\* Suitable for right-hand and left-hand rotation.

For HOMAG®, EIMA®, IMA® FROM 9/94, WEEKE®, BIESSE®, SCM®, MORBIDELLI® and MASTERWOOD® machines.

**NON-STICK ORANGE CHROME® SHIELD COATING**

- prevents overheating
- protects against corrosion and rust
- reduces resin build-up
- longer life and greater tool performance

**SAFETY TIPS:**

The **TW-200** Torque Wrench is recommended for the proper fastening of clamping nuts (see page 266)

## HSK-63F Chucks for "ER40" Precision Collets

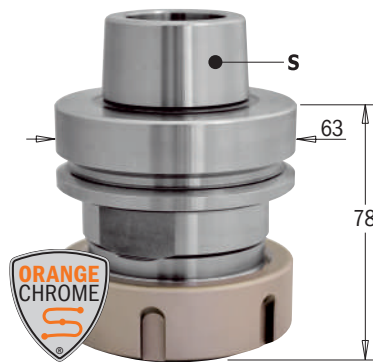

**183.310** X-TREME



ORDER NO. Right-hand rotation	ORDER NO. Left-hand rotation		S	TO BE USED WITH COLLET	NOTE
<b>183.310.01</b>	<b>183.310.02</b>		HSK-63F	ER40	Clamping nut without bearing
<b>183.310.11*</b>		<b>1</b>	HSK-63F	ER40	Clamping nut with bearing

Optional: 990.117.00 M6x6mm screw

\* Suitable for right-hand and left-hand rotation.

For HOMAG®, EIMA®, IMA® FROM 9/94, WEEKE®, BIESSE®, SCM®, MORBIDELLI® and MASTERWOOD® machines.

**NON-STICK ORANGE CHROME® SHIELD COATING**

- prevents overheating
- protects against corrosion and rust
- reduces resin build-up
- longer life and greater tool performance

**SAFETY TIPS:**

The **TW-200** Torque Wrench is recommended for the proper fastening of clamping nuts (see page 266)

## HSK-63F Chucks for "EOC25" Precision Collet "DIN6388"

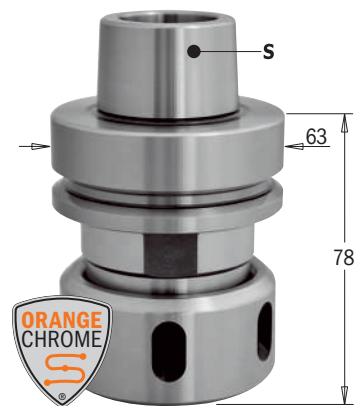

**183.320**



ORDER NO. Right-hand rotation	ORDER NO. Left-hand rotation		S	TO BE USED WITH COLLET	NOTE
<b>183.320.01*</b>		<b>1</b>	HSK-63F	EOC25	Clamping nut with bearing
<b>183.320.03</b>		<b>1</b>	HSK-63F	EOC25	Clamping nut without bearing

Spare parts: 992.283.01 Clamping nut without bearing

992.283.11 Clamping nut with bearing

\* Suitable for left-hand rotation too.

For HOMAG®, EIMA®, IMA® FROM 9/94, WEEKE®, BIESSE®, SCM®, MORBIDELLI® and MASTERWOOD® machines.

**NON-STICK ORANGE CHROME® SHIELD COATING**

- prevents overheating
- protects against corrosion and rust
- reduces resin build-up
- longer life and greater tool performance

**SAFETY TIPS:**

The **TW-200** Torque Wrench is recommended for the proper fastening of clamping nuts (see page 266)

## Universal Assembly Supports for Chucks



**183**

ORDER NO.		D mm	SUITABLE FOR
<b>183-HSK</b>	<b>1</b>	63	HSK-63, BT40, ISO40 DIN 2080, SK40 DIN 69871, CAPTO® C6
<b>183-ISO*</b>	<b>1</b>	50	ISO30, DIN 2080, SK30 DIN 69871, HSK50, CAPTO® C5

\*Not compatible with chucks **183.250** and **183.251**

CMT now offers new universal assembly supports for HSK-63F and ISO30 chucks. Thanks to the bi-directional roller bearings, which clamp the Left-hand rotation to the flange, the system offers the highest protection to the tool taper and clamps are no longer needed.

## ISO30 Chucks for "ER32" Precision Collets

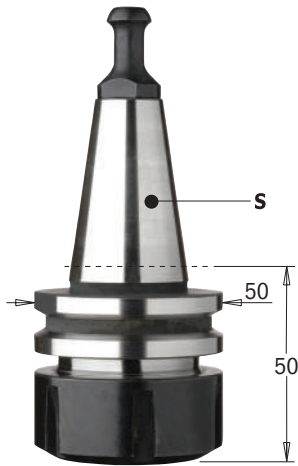

995.200

### 183.200

**RH** **LH**

ORDER NO. Right-hand rotation	ORDER NO. Left-hand rotation		S	TO BE USED WITH COLLET	RETAINING STUD mm
183.200.01	183.200.02	1	ISO30	ER32	Ø12-8

Spare parts: 992.183.01 RH Clamping Nut  
992.183.02 LH Clamping Nut  
991.183.00 C-Spanner "ER32"

For BIESSE® machines.

**SAFETY TIPS:**

The **TW-200** Torque Wrench is recommended for the proper fastening of clamping nuts (see page 266)

## ISO30 Chucks for "ER40" Precision Collets

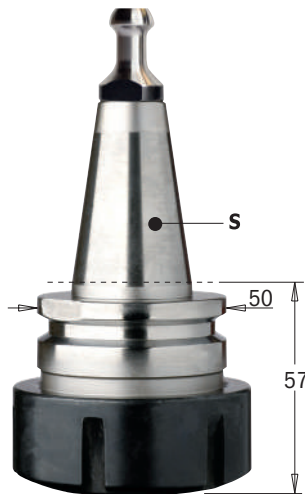

995.200

### 183.201

**RH** **LH**

ORDER NO. Right-hand rotation		S	TO BE USED WITH COLLET	RETAINING STUD mm
183.201.01	1	ISO30	ER40	Ø12-8

Spare parts: 992.383.01 RH Clamping Nut  
991.184.00 C-Spanner "ER40"

For BIESSE® machines.

**SAFETY TIPS:**

The **TW-200** Torque Wrench is recommended for the proper fastening of clamping nuts (see page 266)

## ISO30 Chucks for "ER32" Precision Collets

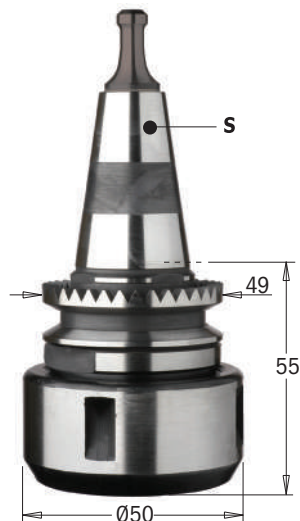

995.250

### 183.250

**RH** **LH**

ORDER NO. Right-hand rotation	ORDER NO. Left-hand rotation		S	TO BE USED WITH COLLET	RETAINING STUD mm
183.250.01	183.250.02	1	ISO30	ER32	Ø8.5

Spare parts: 992.183.01 RH Clamping Nut  
992.183.02 LH Clamping Nut  
991.183.00 C-Spanner "ER32"

For MORBIDELLI® and SCM® machines.

**SAFETY TIPS:**

The **TW-200** Torque Wrench is recommended for the proper fastening of clamping nuts (see page 266)



# Precision Collets "DIN6499"

## 184 TECHNICAL DETAILS:

Replaceable **Standard Precision 0.015** collets. 0; -0.7mm wide clamping tolerance.  
Suitable for most conical chucks. Fit most tapered spindle noses.  
*Special dimensions available on request.*

### RUN-OUT

This tolerance is guaranteed only on the nominal diameter



### ER20

B inches	ORDER NO.
1/4	184.064.20
5/16	184.080.20
3/8	184.100.20
1/2	184.127.20

10 PCS. IN MASTERPACK



### ER25

B inches	ORDER NO.
1/4	184.064.25
5/16	184.080.25
3/8	184.100.25
1/2	184.127.25
5/8	184.160.25

10 PCS. IN MASTERPACK



### ER32

B inches	ORDER NO.
1/4	184.065.00
5/16	184.080.00
3/8	184.095.00
1/2	184.127.00
5/8	184.160.00
3/4	184.190.00
20mm	184.200.00

10 PCS. IN MASTERPACK

For chucks:  
183.000/100/200/250/300/400



### ER40

B inches	ORDER NO.
1/4	184.064.00
5/16	184.082.00
3/8	184.096.00
1/2	184.128.00
5/8	184.162.00
3/4	184.192.00
20mm	184.202.00
25mm	184.252.00

10 PCS. IN MASTERPACK

For chucks:  
183.201/211/221/310

# Precision Collets "DIN6388"

## 185 TECHNICAL DETAILS:

Replaceable **Standard Precision 0.015** collets. 0; -0.7mm wide clamping tolerance.  
Suitable for most conical chucks. Fit most tapered spindle noses.

*Special dimensions available on request.*



### EOC25

B inches	ORDER NO.
1/4	185.064.00
5/16	185.080.00
3/8	185.095.00
1/2	185.127.00
5/8	185.160.00
3/4	185.191.00
20mm	185.200.00
25mm	185.250.00

10 PCS. IN MASTERPACK



### EOC16

B inches	ORDER NO.
5/16	185.080.16
5/8	185.160.16

**new**

10 PCS. IN MASTERPACK



# HSK Chuck for Grooving Blade

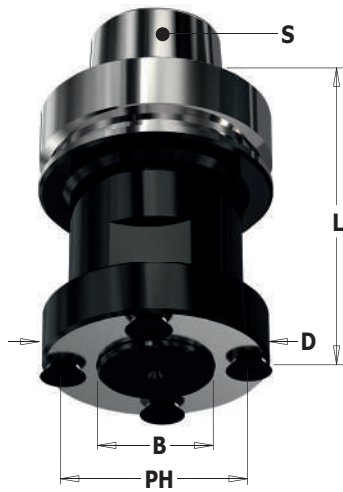

## 183.420

LH RH

ORDER NO.		S	D mm	B mm	PIN HOLE	L mm
183.420.30	1	HSK-63F	59	30	4/M6/48	78

Spare parts: 990.116.00 M6x8,7x12mm TSPEI screw  
991.064.00 4mm allen key



Max saw blade  $\varnothing 10''$  (250mm) for chuck 183.420.30

Do not exceed maximum RPM indicated on the blade.



Grooving saw blades available on request.

**SAFETY TIPS:**



The **TW-006** Torque Screwdriver is recommended for the proper fastening of screws (see page 267).

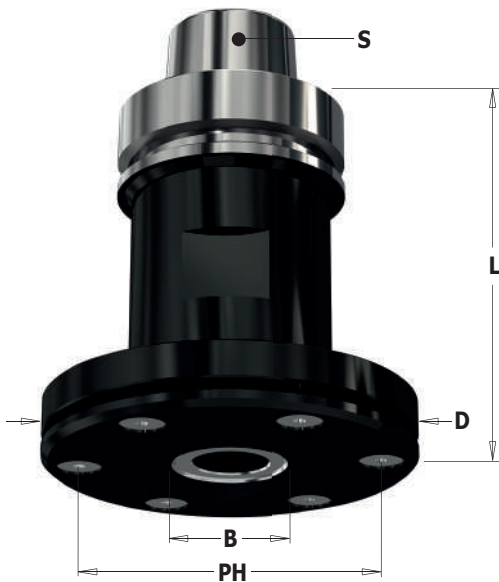

## 183.421

LH RH

ORDER NO.		S	D mm	B mm	PIN HOLE	L mm
183.421.30	1	HSK-63F	98	30	6/M6/80	94

Spare parts: 990.119.00 M6x12x16mm TSPEI screw  
991.064.00 4mm allen key



Max saw blade  $\varnothing 12''$  (300mm) for chuck 183.421.30

Do not exceed maximum RPM indicated on the blade.

with flange  $\varnothing 98\text{mm}$



Grooving saw blades available on request.

**SAFETY TIPS:**



The **TW-006** Torque Screwdriver is recommended for the proper fastening of screws (see page 267).

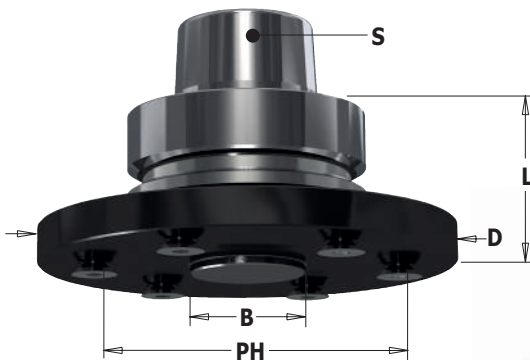

## 183.422

LH RH

ORDER NO.		S	D mm	B mm	PIN HOLE	L mm
183.422.30	1	HSK-63F	110	30	6/M6/80	40

Spare parts: 990.116.00 M6x8,7x12mm TSPEI screw  
991.064.00 4mm allen key



Max saw blade  $\varnothing 14''$  (350mm) for chuck 183.422.30

Do not exceed maximum RPM indicated on the blade.



Grooving saw blades available on request.

**SAFETY TIPS:**



The **TW-006** Torque Screwdriver is recommended for the proper fastening of screws (see page 267).



# XTREME COATING

## THE ULTIMATE TECHNOLOGY FOR INDUSTRIAL CNC TOOLS

DLCS is a modified diamond-like carbon coating with superior load bearing capacity. This hard, durable metal-based finish (chromium nitride) provides an higher hardness surface and enhances the tribological properties of the carbon coating. Its application prevents excessive heat build up which is detrimental to performance. This means cutting tools remain fully effective after every use.

<p><b>Extreme Coating Hardness</b> <b>&gt;HV 2.500</b></p> <p>Offers impressive hardness on cutting edges as well as outstanding protection against wear and tear.</p>	<p><b>Minimal coating thickness</b> <b>µm 2-4</b></p> <p>This micron thin finish guarantees perfectly sharpened edges for high cutting quality.</p>	<p><b>Provides the lowest coefficient of friction</b> <b>0,1-0,2</b></p> <p>Very good running-in and low friction losses. Reduction of sticking. Ideal for high speeds in Nesting applications.</p>	<p><b>Optimal resistance to heat build up</b></p> <p>Reduced overheating. Cutting edges resist excessive wear up to 400°C.</p>
--	---	---	--

### BENEFITS



**3X**  
LONGER LIFE  
THAN UNCOATED

**DLCS CHROME COATING**  
provides 3 times longer life than uncoated tools!



**Test performed in U.S. with 1/2" solid carbide compression spiral bit**

- Machine:** FELDER® Profit H10 Nested Base/Overhead CNC Router
- Working Parameters:** RPM = 18,000 - Feed = 20 mts/minute
- Material:** 19mm Melamine Chipboard
- Application:** Nesting Full Dimensioning
- Performance:** DLCS coated bit cut 165 melamine panels  
Uncoated bit cut 56 melamine panels

FELDER® Profit H10



DLCS coated bit



Melamine Chipboard



Cut quality after 165 panels



# DLCS Chrome Coating Solid Carbide Upcut & Downcut Spiral Bits



**XTREME PERFORMANCE**

**EXTRA HARD DLCS CHROME COATING**

**3X LONGER LIFE THAN UNCOATED**

**LONG LIFE**

## 190.41 COMPRESSION UPCUT & DOWNCUT 2+2-EDGE



ORDER NO.	Right-hand rotation	Box	D inches	D mm	I inches	I Pos. inches	L inches	S inches
190.504.41	10	10	3/8	9.52	1-1/8	9/32	3	3/8
190.505.41	10	10	1/2	12.7	1	15/32	3	1/2
190.506.41	10	10	1/2	12.7	1-1/8	15/32	3	1/2
190.507.41	10	10	1/2	12.7	1-3/8	15/32	3-1/2	1/2
190.508.41	10	10	1/2	12.7	1-5/8	15/32	4	1/2

## 190.41 COMPRESSION UPCUT & DOWNCUT 3+3-EDGE



ORDER NO.	Right-hand rotation	Box	D inches	D mm	I inches	I Pos. inches	L inches	S inches
190.813.41	10	10	3/8	9.52	1	13/64	3	3/8
190.815.41	10	10	1/2	12.7	1-1/8	1/4	3	1/2

## 190.41 MORTISE COMPRESSION UPCUT & DOWNCUT 2+2-EDGE



ORDER NO.	Right-hand rotation	Box	D inches	D mm	I inches	I Pos. inches	L inches	S inches
190.513.41	10	10	3/8	9.52	7/8	3/16	3	3/8
190.515.41	10	10	1/2	12.7	7/8	13/64	3	1/2
190.517.41	10	10	1/2	12.7	1-3/8	13/64	3-1/2	1/2

# Solid Carbide Upcut & Downcut Spiral Bits



## 190 COMPRESSION UPCUT & DOWNCUT 2+2-EDGE



ORDER NO.	Right-hand rotation	Box	D inches	D mm	I inches	I Pos. inches	L inches	S inches
190.008.11	10	10	1/4	6.35	7/8	9/32	2-1/2	1/4
190.504.11	10	10	3/8	9.52	1-1/8	9/32	3	3/8
190.505.11	10	10	1/2	12.7	1	15/32	3	1/2
190.506.11	10	10	1/2	12.7	1-1/8	15/32	3	1/2
190.507.11	10	10	1/2	12.7	1-3/8	15/32	3-1/2	1/2
190.508.11	10	10	1/2	12.7	1-5/8	15/32	4	1/2

## 190 COMPRESSION UPCUT & DOWNCUT 3+3-EDGE



ORDER NO.	Right-hand rotation	Box	D inches	D mm	I inches	I Pos. inches	L inches	S inches
190.813.11	10	10	3/8	9.52	1	13/64	3	3/8
190.815.11	10	10	1/2	12.7	1-1/8	1/4	3	1/2

## 190 MORTISE COMPRESSION UPCUT & DOWNCUT 2+2-EDGE



ORDER NO.	Right-hand rotation	Box	D inches	D mm	I inches	I Pos. inches	L inches	S inches
190.513.11	10	10	3/8	9.52	7/8	3/16	3	3/8
190.515.11	10	10	1/2	12.7	7/8	13/64	3	1/2
190.517.11	10	10	1/2	12.7	1-3/8	13/64	3-1/2	1/2

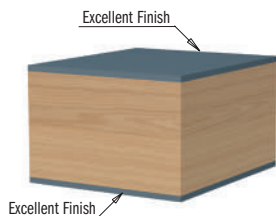

### TECHNICAL DETAILS:

- Premium quality super-micrograin carbide
- 2+2 spiral cutting edges [T2+2].
- 3+3 spiral cutting edges [T3+3].
- Provides excellent finish on both top and bottom sides of the workpiece.

**APPLICATION:** for an excellent edge finish on the top and bottom sides of laminates and double sided melamine. Can also be used with hardwoods and other wood and plastic composites. For fast feed rates on CNC routers, machining centers and point to point machines for ripping, panel sizing, template routing and other routing applications.

# Solid Carbide Upcut 2D/3D Carving Tapered Ball Nose Spiral Bits



## 152



ORDER NO.		D		R	A	I	L	S	T
Right-hand rotation		inches	mm	inches		inches	inches	inches	
<b>152.064.082</b>	10	1/32	0.8	1/64	6.2°	1	3	1/4	3
<b>152.064.162</b>	10	1/16	1.6	1/32	5.4°	1	3	1/4	3
<b>152.064.322</b>	10	1/8	3.2	1/16	3.6°	1	3	1/4	3
<b>152.127.635</b>	10	1/4	6.4	1/8	3°	2	4	1/2	2

### TECHNICAL DETAILS:

- Premium quality HWM.
- Upcut spiral cutting edges [T2/T3].
- **Excellent finish on the lower side of the work piece.**
- Upward chip ejection.

### APPLICATION:

- specially designed for 2D and 3D CNC profiling and carving in plastic, aluminum & wood for several uses like:
- A perfect bit for 3D carving
  - Precision 2D and 3D large scale carving
  - Great for deep profiling
  - Dimensional signage
  - 3D millwork
  - 2D and 3D contouring, profiling, modeling and pattern making for cabinetry, sign making, furniture making and jewelry mold making
  - Perfect for model-makers on large 3D milling profiles in abrasive EPS foam and other materials.
  - **Ideal on aluminum, plastic and wood-based materials.**

### EXCELLENT FOR CUTTING

- Acrylonitrile-Butadiene-Styrene (ABS)
- Acrylic
- Acrylic Stone
- Aluminum
- Brass
- Bronze
- Composite
- Copper
- Ethylene-vinyl Acetate Foam (EVA)
- Expanded Polypropylene (EPP)
- Expanded Polystyrene Foam (EPS)
- Extruded Polystyrene Foam (XPS)
- Fiberglass
- Fiberglass PCB Board
- Foam Board
- Graphite
- HDPE
- HDU
- 20lbs High Density Urethane
- MDF/HDF
- Phenolics
- Phenolic Composites
- Plastics
- Poly (methyl methacrylate) (PMMA)
- Polyethylene Foam
- Polyurethane Foam
- PVC
- PVC Foam Board
- Sign Board
- Sign Foam
- Titanium
- Tooling Board
- Wood
- XPE (Cross Linked Polyethylene) Foam

### ALSO EXCELLENT FOR

- CORIAN®
- COROPLAST®
- DIBOND®
- ETHAFOAM®
- LEXAN®
- PALFOAM®
- POLYLAM®

### TIPS FOR MILLING PLASTICS

- pay attention to heat input
- pay attention to chip-loads when using small diameters
- use air-blast to keep chip away and cooling the tool

# Solid Carbide Spiral Bits



## 198 UPCUT 1-EDGE



ORDER NO.		D		I	L	S
Right-hand rotation		inches	mm	inches	inches	inches
<b>198.001.11</b>	10	1/8	3.18	1/2	2	1/4
<b>198.005.11</b>	10	3/16	4.76	5/8	2	1/4
<b>198.007.11</b>	10	1/4	6.35	3/4	2	1/4
<b>198.008.11</b>	10	1/4	6.35	1	2-1/2	1/4
<b>198.504.11</b>	10	3/8	9.52	1-1/8	3	3/8

### TECHNICAL DETAILS:

- Premium quality HWM.
- 1 spiral cutting edge [T1].
- **Provide an excellent finish on the lower side of the workpiece.**
- Upward chip ejection.

### APPLICATION:

used for efficient contour cutting, end-trimming and panel sizing on solid wood, wood composites, plastic materials and laminates at high feed speed. Ensure to properly clamp workpieces. Can be used on machining centres, point-to-point boring machines, CNC routers and hand-held routers equipped with chucks or adapters.



# Solid Carbide Upcut Spiral Bits



## 191



ORDER NO. Right-hand rotation		D		I inches	L inches	S inches
		inches	mm			
191.001.11	10	1/8	3.18	1/2	2	1/4
191.003.11	10	5/32	3.97	1/2	2	1/4
191.005.11	10	3/16	4.76	3/4	2	1/4
191.007.11	10	1/4	6.35	3/4	2	1/4
191.008.11	10	1/4	6.35	1	2-1/2	1/4
191.501.11	10	5/16	7.94	1	3	1/2
191.503.11	10	3/8	9.52	1-1/4	3-1/4	1/2
191.505.11	10	1/2	12.7	1-1/4	3	1/2
191.506.11	10	1/2	12.7	1-1/2	3-1/2	1/2
191.507.11	10	1/2	12.7	2	4	1/2

### TECHNICAL DETAILS:

- Premium quality HWM.
- 2 spiral cutting edges [T2].
- **Provide an excellent finish on the lower side of the workpiece.**
- Upward chip ejection.

### APPLICATION:

used for efficient contour cutting, end-trimming and panel sizing on solid wood, wood composites, plastic materials and laminates at high feed speed. Ensure to properly clamp workpieces. Can be used on machining centres, point-to-point boring machines, CNC routers and hand-held routers equipped with chucks or adapters.

# Solid Carbide Downcut Spiral Bits



## 192



ORDER NO. Right-hand rotation		D		I inches	L inches	S inches
		inches	mm			
192.001.11	10	1/8	3.18	1/2	2	1/4
192.003.11	10	5/32	3.97	1/2	2	1/4
192.005.11	10	3/16	4.76	3/4	2	1/4
192.007.11	10	1/4	6.35	3/4	2	1/4
192.008.11	10	1/4	6.35	1	2-1/2	1/4
192.501.11	10	5/16	7.94	1	3	1/2
192.503.11	10	3/8	9.52	1-1/4	3-1/4	1/2
192.505.11	10	1/2	12.7	1-1/4	3	1/2
192.506.11	10	1/2	12.7	1-1/2	3-1/2	1/2
192.507.11	10	1/2	12.7	2	4	1/2
10 PCS. IN MASTERPACK						
192.008.11-X10		1/4	6.35	1	2-1/2	1/4
192.501.11-X10		5/16	7.94	1	3	1/2
192.505.11-X10		1/2	12.7	1-1/4	3	1/2

### TECHNICAL DETAILS:

- Premium quality HWM.
- 2 spiral edges [T2].
- **Provide an excellent finish on the upper side of the workpiece.**
- Downward chip ejection.

### APPLICATION:

used for efficient contour cutting, end-trimming and panel sizing on solid wood, wood composites, plastic materials and laminates at high feed speed. Ensure to properly clamp workpieces. Can be used on machining centres, point-to-point boring machines, CNC routers and hand-held routers equipped with chucks or adapters.



X10 (10 PCS. IN MASTERPACK)



**192.41** DLCS Chrome Coating Long Life



SEE PAGE 280

## Solid Carbide Upcut Spiral Bits with Chip-Breaker



**195**



ORDER NO. Right-hand rotation	10	D		I	L	S
		inches	mm	inches	inches	inches
<b>195.506.11</b>		1/2	12.7	1-1/2	3-1/2	1/2

**TECHNICAL DETAILS:**

- Premium quality S.T.C.
- 3 spiral cutting edges [T3R].
- Chip breaker teeth.
- Max 0.3mm tooth depth.
- **Provide an excellent finish on the lower side of the workpiece.**
- Upward chip ejection.

**APPLICATION:**

used for efficient contour cutting, end-trimming and panel sizing on solid wood, wood composites, plastic materials and laminates at high feed speed. Ensure to properly clamp workpieces. Can be used on machining centres, point-to-point boring machines, CNC routers and hand-held routers equipped with chucks or adapters.

## Solid Carbide Downcut Spiral Bits with Chip-Breaker

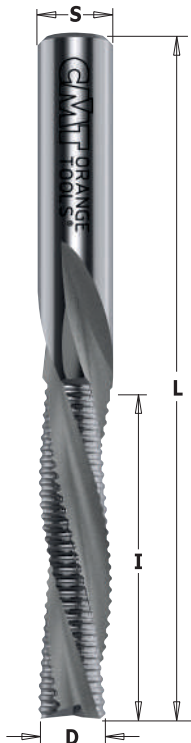

**196**



ORDER NO. Right-hand rotation	10	D		I	L	S
		inches	mm	inches	inches	inches
<b>196.506.11</b>		1/2	12.7	1-1/2	3-1/2	1/2

**TECHNICAL DETAILS:**

- Premium quality S.T.C.
- 3 spiral cutting edges [T3R].
- Chip breaker teeth.
- Max 0.3mm tooth depth.
- **Provide excellent finish on the upper side of the workpiece.**
- Downward chip ejection.

**APPLICATION:**

used for efficient contour cutting, end-trimming and panel sizing on solid wood, wood composites, plastic materials and laminates at high feed speed. Ensure to properly clamp workpieces. Can be used on machining centres, point-to-point boring machines, CNC routers and hand-held routers equipped with chucks or adapters.

# Straight Bits for Industrial Nesting Application **DLCS Chrome Coating**



**new**



**812** **XREME**  
PERFORMANCE

SOLID CARBIDE **T3** **RH** **LONG LIFE**

ORDER NO.		D		I	L
S=Ø1/2" shank		inches	mm	inches	inches
<b>812.564.11</b>	<b>10</b>	1/4	6.35	1	2-7/8
<b>812.581.11</b>	<b>10</b>	5/16	8	1-1/8	3

**TECHNICAL DETAILS:**

- Premium quality HWM.
- Special positively ground cutting edge sharpening for excellent finish.



**DLCS CHROME COATING:**

- Superb wear resistance
- Better chip clearance
- Superior cutting quality
- Less overheating
- More productivity

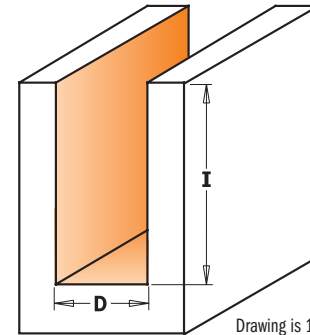

Drawing is 1:1 scale

**3X**  
LONGER LIFE  
THAN UNCOATED

## DLCS CHROME COATING

provides 3 times longer life than uncoated tools!

# Solid Carbide Downcut Spiral Bits **DLCS Chrome Coating**

**new**

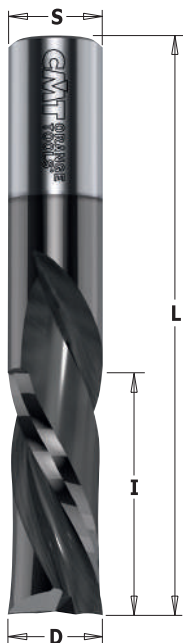

**192.41** **XREME**  
PERFORMANCE

SOLID CARBIDE **T2** **RH** **LONG LIFE**

ORDER NO.		D		I	L	S
Right-hand rotation		inches	mm	inches	inches	inches
<b>192.007.41</b>	<b>10</b>	1/4	6.35	3/4	2	1/4
<b>192.008.41</b>	<b>10</b>	1/4	6.35	1	2-1/2	1/4
<b>192.503.41</b>	<b>10</b>	3/8	9.52	1-1/4	3-1/4	1/2
<b>192.505.41</b>	<b>10</b>	1/2	12.7	1-1/4	3	1/2
<b>192.506.41</b>	<b>10</b>	1/2	12.7	1-1/2	3-1/2	1/2
<b>192.507.41</b>	<b>10</b>	1/2	12.7	2	4	1/2



**DLCS CHROME COATING:**

- Superb wear resistance
- Better chip clearance
- Superior cutting quality
- Less overheating
- More productivity

**3X**  
LONGER LIFE  
THAN UNCOATED

## DLCS CHROME COATING

provides 3 times longer life than uncoated tools!

# Solid Surface and Fiberglass Bit with DLCS Chrome Coating



**151** XTREME PERFORMANCE



ORDER NO. Right-hand rotation		D		I	L	S
		inches	mm	inches	inches	inches
<b>151.064.25E</b>	10	1/4	6.35	1	2-1/2	1/4
<b>151.127.38E</b>	10	1/2	12.7	1-1/2	3-1/2	1/2

**TECHNICAL DETAILS:**

- Premium quality S.T.C.
- Special positively ground cutting edge sharpening for excellent finish

**APPLICATION:** used for efficient contour cutting, end-trimming and panel sizing on glass fiber and fiberglass, phenolic and composite material. For use on machining centres, point-to-point boring machines, CNC routers and hand-held routers equipped with chucks or adapters.



**DLCS CHROME COATING:**

- Superb wear resistance
- Better chip clearance
- Superior cutting quality
- Less overheating
- More productivity



## DLCS CHROME COATING

provides 3 times longer life than uncoated tools!

# Solid Surface and Fiberglass Bit with DLCS Chrome Coating



**151** XTREME PERFORMANCE



ORDER NO. Right-hand rotation		D		I	L	S
		inches	mm	inches	inches	inches
<b>151.064.25D</b>	10	1/4	6.35	1	2-1/2	1/4
<b>151.127.38D</b>	10	1/2	12.7	1-1/2	3-1/2	1/2

**TECHNICAL DETAILS:**

- Premium quality S.T.C.
- Special positively ground cutting edge sharpening for excellent finish

**APPLICATION:** used for efficient contour cutting, end-trimming and panel sizing on fiberglass, glass fiber phenolic and composite material. The 135° tooth geometry allows vertical feeding minimizing the bending of the workpiece. To be used on machining centres, point-to-point boring machines, CNC routers and hand-held routers equipped with chucks or adapters.



**DLCS CHROME COATING:**

- Superb wear resistance
- Better chip clearance
- Superior cutting quality
- Less overheating
- More productivity

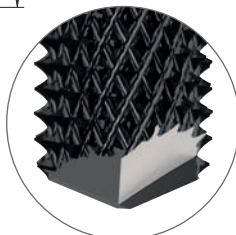

Sharpening 135°



## DLCS CHROME COATING

provides 3 times longer life than uncoated tools!



# Diamond Compression Bits



## 140



ORDER NO. Right-hand rotation		D		I	L	S	T
		inches	mm	inches	inches	inches	
<b>140.127.61</b>	1	1/2	12.7	1-1/16	2-61/64	1/2	1+1 (3DP+1TCT)
<b>140.128.61</b>	1	1/2	12.7	1-3/8	3-11/32	1/2	1+1 (4DP+1TCT)
<b>140.158.61</b>	1	5/8	15.87	1-1/16	3-11/32	5/8	1+1 (3DP+1TCT)
<b>140.159.61</b>	1	5/8	15.87	1-49/64	4-1/16	5/8	1+1 (5DP+1TCT)
<b>140.190.61</b>	1	3/4	19.05	1-1/16	3-11/32	3/4	1+1 (3DP+1TCT)
<b>140.192.61</b>	1	3/4	19.05	1-49/64	4-1/8	3/4	1+1 (5DP+1TCT)

### TECHNICAL DETAILS:

- Super strength steel.
- Shear angle.
- DP cutting edge (H2,5).
- HW plunging tip for diagonal plunge-cutting.
- Resharpeable (max 3 times).
- Max feed speed 5 m/min.

### APPLICATION:

for contour cutting and panel sizing on hard and abrasive materials such as laminates, MDF and melamine. For use on machining centers, point to point boring machines and CNC pantographs equipped with adaptors and chucks.

# Straight Router Cutters with Insert Knives



## 653



ORDER NO. Right-hand rotation		D		I	L	S	Spare parts	
		inches	mm	mm	mm	inches		
<b>653.158.11</b>	10	5/8	15.8	28.3	92	1/2	790.283.12	790.075.00

- Spare parts:
- 990.072.00** M3,5x3,5mm TORX® screw
  - 990.074.00** M4x3,5mm TORX® screw
  - 990.075.00** M4x6mm TORX® screw
  - 991.061.00** T15 TORX® key

### TECHNICAL DETAILS:

- Super strength steel.
- 2 cutting edges [T1+1].

### APPLICATION:

straight router bits with on replaceable plunging knife and side knife fixed by a special TORX® screw. The tool bodies are precisely balanced. For finishing, routing, plunging and grooving on board materials (laminated chipboards and MDF) and hardwood. For use on portable routers or CNC machining centres.

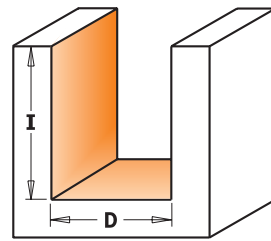
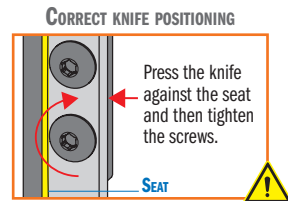

Drawing is 1:1 scale

### SAFETY TIPS:

The **TW-006** Torque Screwdriver is recommended for the proper fastening of screws (see page 267).

# Spoilboard Surfacing Router Cutters with Insert Knives



**663**



ORDER NO.	Box	D	I	L	T	S	Spare parts	
Right-hand rotation		inches	mm	mm	mm	mm		
<b>663.005.11</b>	10	1-1/2	38	12	60	3	790.120.03*	990.075.00
<b>663.015.11</b>	10	1-1/2	38	12	60	3	790.120.03*	990.075.00
<b>663.004.11</b>	10	2-3/8	60	12	80	3	790.120.03*	990.075.00
<b>663.014.11</b>	10	2-3/8	60	12	80	3	790.120.03*	990.075.00
<b>663.003.11</b>	10	3-5/32	80	12	90	3	790.120.03*	990.075.00
<b>663.006.11</b>	1	3-15/16	100	12	90	4	790.120.03*	990.075.00

**Spare parts:** **991.061.00** T15 TORX® key  
**990.036.00** M8x25mm TE screw (for 663.003.11 and 663.006.11)  
**990.020.00** Hex nut for threaded arbors M8 (for 663.003.11 and 663.006.11)  
 \*Minimum 10 pieces or multiple

**TECHNICAL DETAILS:**  
 - Super strength steel.  
 - 3 cutting edges [T3].  
 - 4 cutting edges [T4].

**APPLICATION:** the new router bit for CNC routers is ideal for fast removal of material over a large surface area leaving an improved finish at the bottom of the cut. Used on soft and hardwood, particle board and MDF. The cutter uses 4-sided inserts in super micrograin carbide.  
 A cost effective solution compared to brazed router bits and solid carbide spiral bits.

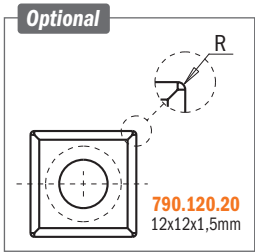

**SAFETY TIPS:**  
 The **TW-006** Torque Screwdriver is recommended for the proper fastening of screws (see page 267).

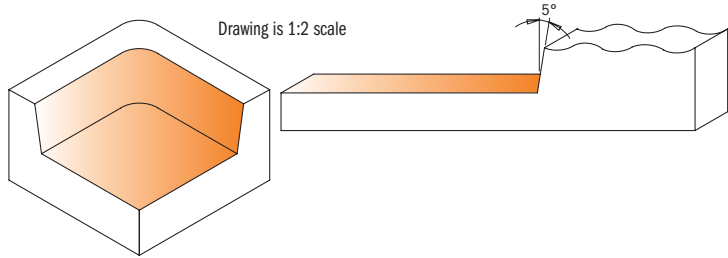

# Spoilboard Surfacing Router Cutters

**new**

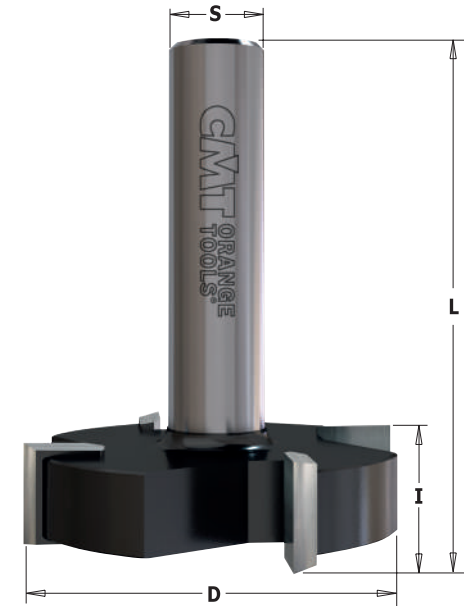

**178**



ORDER NO.	Box	D	I	L	T	S
Right-hand rotation		inches	mm	inches	inches	inches
<b>178.701.11</b>	1	1	25.4	1/4	1-5/8	3
<b>178.704.11</b>	1	2	50.8	1/2	2-1/2	4

**TECHNICAL DETAILS:**  
 - Super-strength steel.  
 - 3 cutting edge [T3]  
 - 4 cutting edge [T4]

**APPLICATION:** the new router bit for CNC routers is ideal for fast removal of material over a large surface area leaving an improved finish at the bottom of the cut. Used on soft and hardwood, particle board and MDF. The cutter uses 4-sided inserts in super micrograin carbide.  
 A cost effective solution compared to brazed router bits and solid carbide spiral bits.

# XTreme Spoilboard Surfacing Router Cutter with Insert Knives



**new**

**663.5 XTREME**



ORDER NO.	Right-hand rotation	D	I	L	S
		inches	mm	inches	inches
<b>663.501.11</b>	<b>10</b>	2	50.8	1	2-1/2

Spare parts	
790.140.20*	990.080.00

**TECHNICAL DETAILS:**  
 - Super strength steel  
 - 6 + 3 cutting edges [T6+V3]

\*Minimum 10 pieces or multiple

**APPLICATION:** this new router bit designed for CNC router machines and stationary router machine work centers are ideal for rabbeting joints and for quick chip removal on large surface areas and leaves a good finish at the bottom of the cut. Ideal for soft and hard wood, particle board and MDF. This bit is equipped with 4 sided insert knives in super micrograin carbide - an economical solution for brazed and solid carbide spiral bits.



**NOTE:** for optimum finish, radius inserts **790.140.20** are recommended.

**790.140.20**  
14x14x2mm

**SAFETY TIPS:**  
 The **TW-006** Torque Screwdriver is recommended for the proper fastening of screws (see page 267).

# XTreme Plunge CNC Cutters with Insert Knives



**653 XTREME**



ORDER NO.	Right-hand rotation	D	I	L	S
		inches	mm	mm	mm
<b>653.001.11</b>	<b>10</b>	1-5/8	40	29.5	100

Spare parts	
790.295.12	790.120.00

**Spare parts:** **990.075.00** M4x6mm TORX® screw  
**991.061.00** T15 TORX® key  
**990.036.00** M8x25mm TE screw  
**990.020.00** Hex nut for threaded arbors M8

**TECHNICAL DETAILS:**  
 - Super strength steel.  
 - 4 cutting edges [T2+2]

**APPLICATION:** the new CNC cutter is designed with 2 plunging knives and two-sided knives fixed by special TORX® screws. It is ideal for direct plunge into the material and fast removal over a large surface area leaving an improved finish at the bottom of the cut. For cutting soft/hard wood, chipboard, melamine, MDF. For use on pantograph CNC machines.

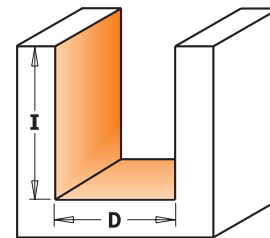
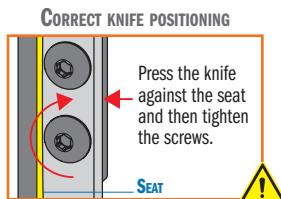

Drawing is 1:1 scale

**SAFETY TIPS:**  
 The **TW-006** Torque Screwdriver is recommended for the proper fastening of screws (see page 267).

# V-Groove - Folding - Signmaking CNC Router Cutters with Insert Knives



## 663.1



ORDER NO.	Right-hand rotation	Box	D inches	D mm	A	I mm	L mm	S mm	T
663.103.11	10	10	1-3/8	35	45°	42	125	20x50	1
663.102.11	5	5	1-21/32	42	60°	35	115	20x50	1
663.101.11	1	1	2-3/64	52	91°	25	102	20x50	1
663.110.11	1	1	2-3/8	60	110°	21	95	20x60	1
663.120.11	1	1	3-27/64	87	120°	24	95	20x50	2
663.130.11	1	1	3-37/64	91	130°	20.2	95	20x50	2
663.150.11	1	1	3-51/64	96.5	150°	12.4	95	20x50	2

Spare parts

	790.580.01*
	790.580.01*
	790.360.01*
	790.360.01*
	790.496.01*
	790.496.01*
	790.496.01*

Spare parts: **990.073.00** M3,5x5x7,2mm TORX® T15 screw (for 790.580.01 and 790.360.01)  
**990.075.00** M4x6x8,2mm TORX® T15 screw (for 790.496.01)  
**991.061.00** T15 TORX® key  
**990.036.00** M8x25mm TE screw  
**990.020.00** Hex nut for threaded arbors M8

\*Minimum 10 pieces or multiple

Optional **S790.360.03\*** 36x12x1,5mm HW-SMG replaceable knife (4 cutting edges 35°)

### CORRECT KNIFE POSITIONING

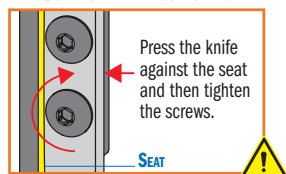

### SAFETY TIPS:

The **TW-006** Torque Screwdriver is recommended for the proper fastening of screws (see page 267).

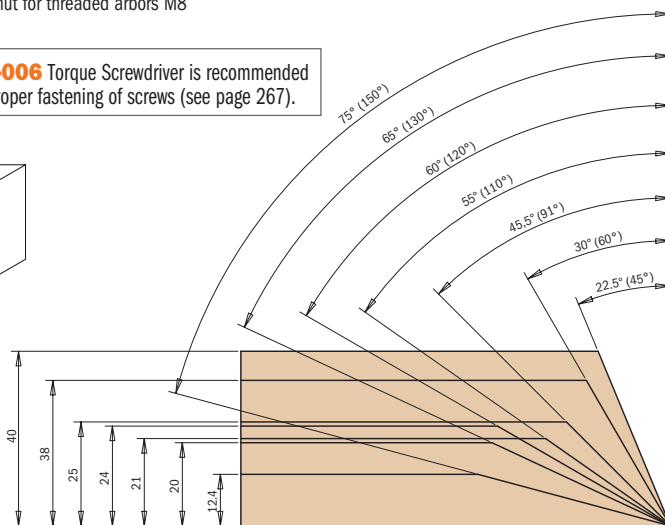
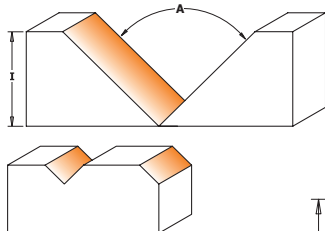

### TECHNICAL DETAILS:

- Super strength steel.
- 1 cutting edge [T1]
- 2 cutting edges [T2]

**APPLICATION:** this innovative CNC router bit offers you an endless range of possibilities for V-Groove, miter folds, signmaking, lettering and chamfer edges. The tool mounts a high grade HWM reversible knife ideal for general purpose, chipboard and plywood, but knives with increased hardness are available for laminated and MDF material.

## Universal Profile Cutter for CNC Machines



Suggested  
MAX RPM 12.000

KNIVES  
NOT INCLUDED

## 663.301



ORDER NO.	Right-hand rotation	Box	D inches	D mm	I mm	L mm	S mm
663.301.11	1	1	2-9/16	65	40-50	93	20

Spare parts: **692.999.01** 38x15x16mm wedge for cutter  
**990.064.00** M8x16mm STEI screw  
**991.064.00** Hex key 4mm

### TECHNICAL DETAILS:

- Super Strength steel.
- 2 cutting edges [T2] for knives 40x4mm and 50x4mm.

**APPLICATION:** for universal profiling of solid wood on CNC router machines. For cutting width 40mm and 50mm (serie 690). Profile knives may only be ordered and used in pairs.  
 For router machines with mechanical feed.

**USEFUL TIPS:** for enhanced safety, when using 50mm knives, it is recommended to carry out the cut in several passes.

### TO BE USED WITH SP KNIVES SERIES 690 (SEE PAGE 337~349)

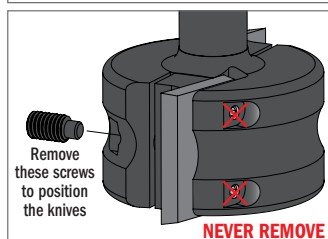
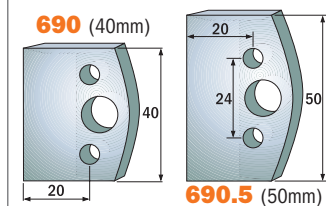

### SAFETY TIPS:

The **TW-006** Torque Screwdriver is recommended for the proper fastening of screws (see page 267).



# Adjustable Chamfering CNC Cutter

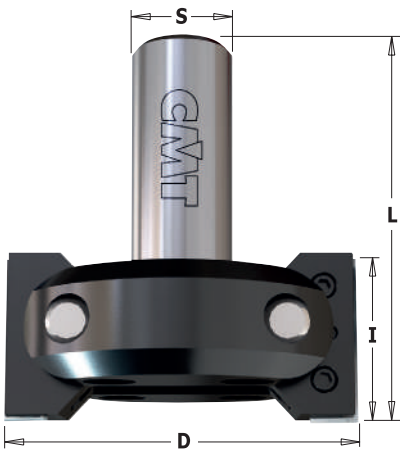

## 663.201



ORDER NO.		D	D_Max 45°	I	A	L	S
Right-hand rotation		inches	mm	inches		inches	mm
<b>663.201.11</b>	<b>1</b>	3-11/32	85	4-1/32	1-9/16	0°-45° - 0°+90°	3-5/8 20

**Spare parts:** **790.395.12** 39.5x12x1.5mm knife (Minimum 10 pieces or multiple)

**663.999.01** 38x6x12mm wedge

**990.087.00** M6x8mm STEI screw (4x2mm threaded pin)

**991.067.00** 3mm hex key

**663.999.02** Kit with 2 wedges and 1 screw for blocking rotation

**990.099.00** M8x25mm TCEI screw

**990.023.00** M8 (4mm) nut

**991.081.00** 4mm "T" hex key

### SAFETY TIPS:



The **TW-006** Torque Screwdriver is recommended for the proper fastening of screws (see page 267).

### TECHNICAL DETAILS:

- Tool body in steel
- 2 reversible S.T.C. knives 39.5x12x1.5mm [T2]
- Peripheral cutting on both sides
- Adjustable swivelling blade (Rotates at 7,5° intervals; Precision = 7.5°)
- Swivelling range 0-45° towards top, and 0-90° towards bottom

**APPLICATION:** for jointing, rebating and chamfering of solid wood and wooden boards. Suitable for CNC router machines and stationary router machine with manual or mechanical feed. Never modify the chamfering angle whilst changing the knives. RH rotation.

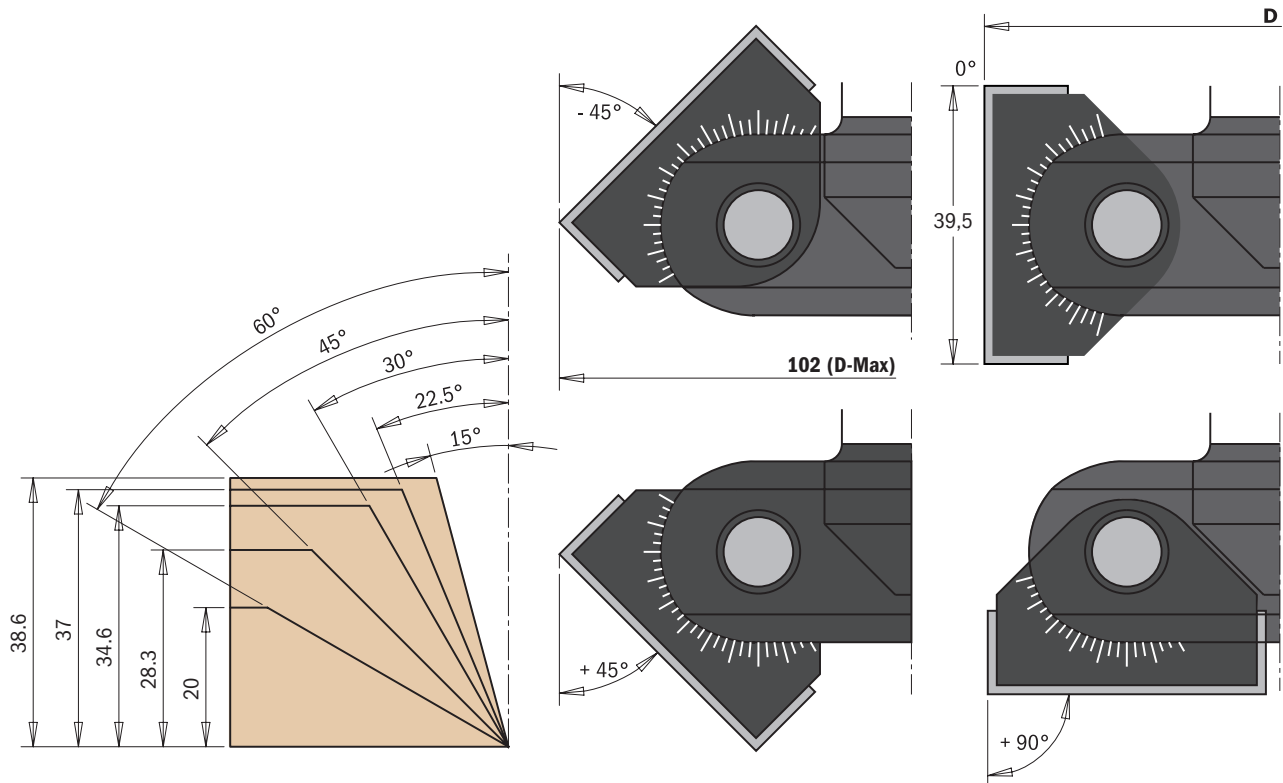

# DOWEL DRILLS & BORING BITS

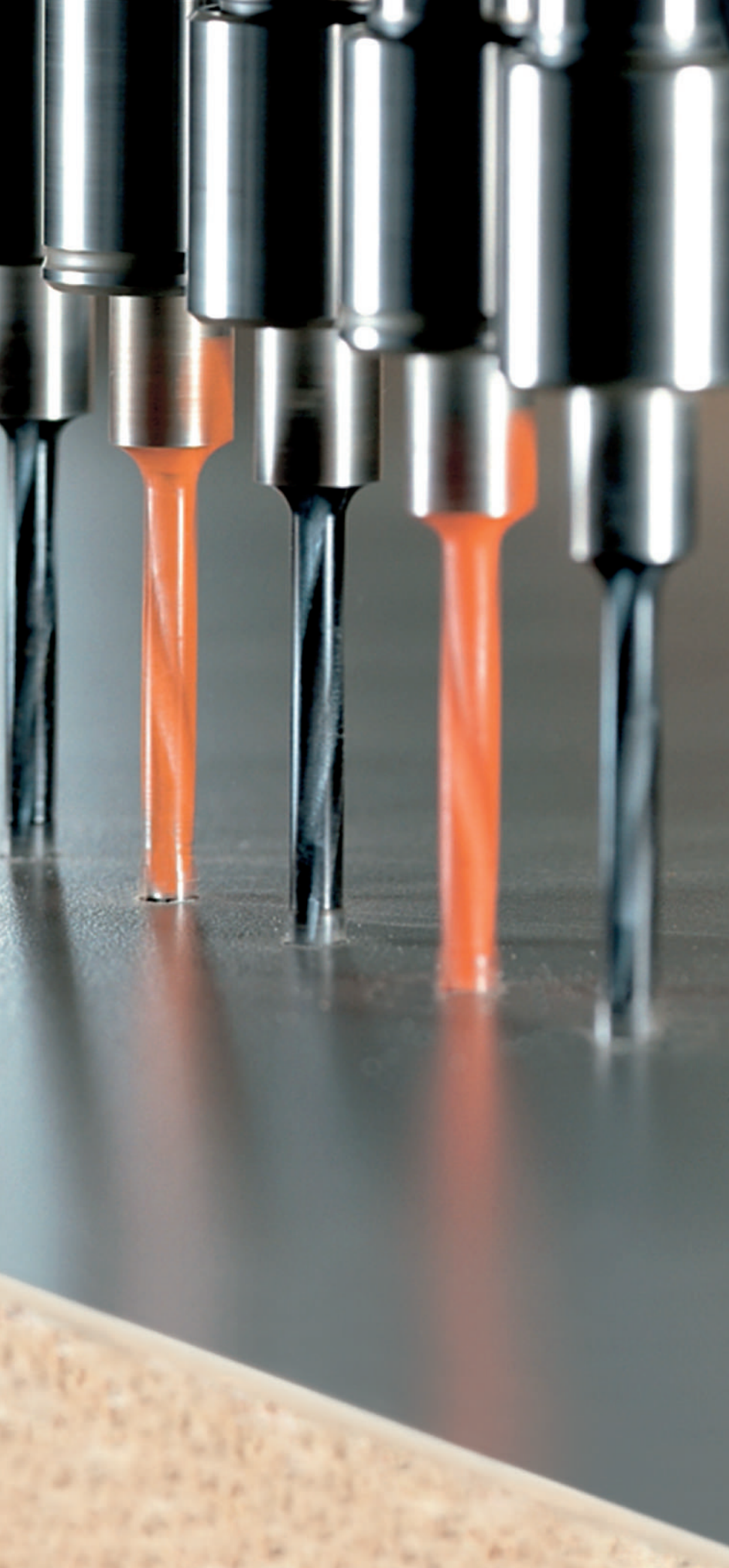





<b>PRODUCTS</b>	<b>PAGE</b>
Adapters	288-289
Solid Carbide Dowel Drills for Through Holes	290
Dowel Drills for Through Holes	290
Solid Carbide Dowel Drills	291
Dowel Drills	292
2 Flute Dowel Drills	293-294
Dowel Drills with Countersinks	294
4 Flute Dowel Drills	295~297
Solid Carbide Twist Drills	298
Adapters & Bushings for Twist Drills	298
2 Flute Dowel Drills for Through Holes	299
Hinge Boring Bits	300



# Maximizing Boring Performance

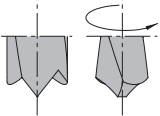
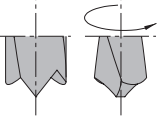
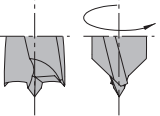

LINE	XTREME	XTREME	INDUSTRIAL
PERFORMANCE	SUPERIOR ★★★★★	EXCELLENT ★★★★★	VERY GOOD ★★★
BIT			
DESCRIPTION	Designed for heavy duty drilling in Large-Scale Industrial Manufacturing ensuring high impact resistance and greater durability.	Designed for heavy-duty to medium-duty drilling in large-scale to medium-scale industrial manufacturing ensuring high impact resistance and greater durability.	Designed for medium-duty to light-duty drilling in medium-scale to small-scale industrial manufacturing ensuring rigorous impact resistance and good durability.
USER	LARGE-SCALE INDUSTRIAL MANUFACTURING	LARGE-SCALE TO MEDIUM-SCALE INDUSTRIAL MANUFACTURING	MEDIUM-SCALE TO SMALL-SCALE INDUSTRIAL MANUFACTURING
RECOMMENDED USE	INDUSTRIAL PRODUCTION	INDUSTRIAL/REMODELER	REMODELER
MATERIALS	Ideal for chipboard, MDF, HDF and laminates.	Excellent for both hard and soft wood. Great for chipboard, MDF, HDF and laminates.	Excellent for both hard and soft wood. Good for chipboard, MDF, and laminates.
SHARPENING & MAINTENANCE	<p>Specially designed reinforced spurs allow for impeccable finishing during operations involving high-speed cutting feed.</p>  <p>XTREME SHARPENING</p>	<p>Specially designed reinforced spurs allow for impeccable finishing during operations involving high-speed cutting feed.</p>  <p>XTREME SHARPENING</p>	<p>Standard design with negatively ground spurs providing good quality finishing without chipping.</p>  <p>NEGATIVELY GROUND SPURS</p>
CARBIDE	INDUSTRIAL CHROMIUM MICROGRAIN CARBIDE The special chromium enhanced carbide produces clean bores with no rough edges and maintains a balanced center point. In addition to its safety features, Chromium Micrograin Carbide guarantees exceptional resistance to fatigue and abrasion and allows for an infinite number of resharpenings.	INDUSTRIAL SINTERHIP HI-DENSITY CARBIDE The unique tip is made of high quality carbide enhanced via Sinterhip (hot isostatic pressing). This process guarantees long lasting performance and exceptionally clean bores.	INDUSTRIAL GRADE CARBIDE Fine and medium grain carbide grade guarantee reliable prolonged use.
COATING	 SOLID TUNGSTEN CARBIDE	CMT P.T.F.E. COATING provides a non-stick surface preventing resin, glue or sludge residue accumulation on the bit body. Baked at 420°, this unique industrial material is specifically designed to fit woodworking tool requirements.	CMT P.T.F.E. COATING provides a non-stick surface preventing resin, glue or sludge residue accumulation on the bit body. Baked at 420°, this unique industrial material is specifically designed to fit woodworking tool requirements.
PRICE RANGE	HIGH	MEDIUM/HIGH	MEDIUM

## Adapters





### 360.001

**RH** **LH**

ORDER NO. Right-hand rotation	ORDER NO. Left-hand rotation		B mm	d mm	D mm
<b>360.001.01</b>	<b>360.001.02</b>	<b>10</b>	10	20	15

**FOR USE ON THE FOLLOWING MACHINES:**  
BIESSE® machines with quick drill change chuck.

Spare parts	
	
990.007.00	991.067.00



### 360.101

LH RH

ORDER NO. Right-hand & Left-hand rotation		B mm	d mm	D mm
<b>360.101.00</b>	<b>10</b>	10	17.5	18

**FOR USE ON THE FOLLOWING MACHINES:**  
VITAP®.

Spare parts	
990.015.00	991.062.00



### 360.201

LH RH

ORDER NO. Right-hand & Left-hand rotation		B mm	d mm	D mm
<b>360.201.00</b>	<b>10</b>	10	19.5	20

**FOR USE ON THE FOLLOWING MACHINES:**  
MORBIDELLI®.

Spare parts	
990.015.00	991.062.00



### 360.301

LH RH

ORDER NO. Right-hand & Left-hand rotation		B mm	d mm	D mm
<b>360.301.00</b>	<b>10</b>	10	19.5	20

**FOR USE ON THE FOLLOWING MACHINES:**  
MASTERWOOD®, MAGGI®, FELDER®,  
GRIGGIO®.

Spare parts	
990.015.00	991.062.00



### 360.401

LH RH

ORDER NO. Right-hand & Left-hand rotation		B mm	d mm	D mm
<b>360.401.00</b>	<b>10</b>	10	20	17

**FOR USE ON THE FOLLOWING MACHINES:**  
WEEKE®.

Spare parts	
990.009.00	991.067.00

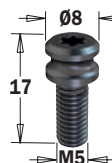

### 990.088

LH RH

ORDER NO. Right-hand & Left-hand rotation		DESCRIPTION
<b>990.088.00</b>	<b>10</b>	Retaining screw for WEEKE® machines



# Solid Carbide Dowel Drills for Through Holes

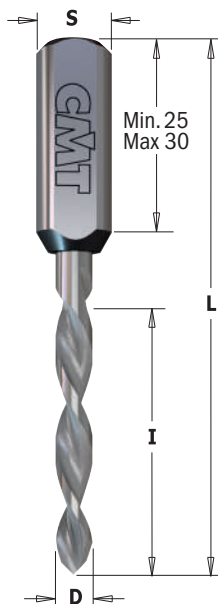

## 314.21/22 XTREME

SOLID CARBIDE LONG LIFE T2 RH LH

ORDER NO. Right-hand rotation	ORDER NO. Left-hand rotation		D inches	D mm	I mm	L mm	S mm
314.030.21	314.030.22	50	3*	27	70	10x30	
314.040.21	314.040.22	50	5/32	4	35	70	10x25
314.050.21	314.050.22	50		5	35	70	10x25
314.060.21	314.060.22	50		6	35	70	10x25
314.070.21	314.070.22	50		7	35	70	10x25
314.080.21	314.080.22	50	5/16	7.94	35	70	10x26

NEW

\* "V" point 60° sharpening

For panels with maximum 20-30mm in thickness

### TECHNICAL DETAILS:

- Premium quality super-strength steel shank.
- High quality S.T.C. body.
- 2 precision ground cutting edges [T2].
- double angle.
- 2 spiral flutes.
- Parallel shank with driving flat and adjustable screw length.

**APPLICATION:** for drilling through holes in solid wood, wood derivatives and laminates. For use on boring machine centres equipped with adaptors and/or chucks.

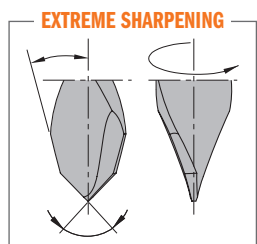
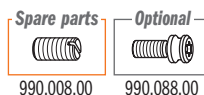

# Dowel Drills for Through Holes

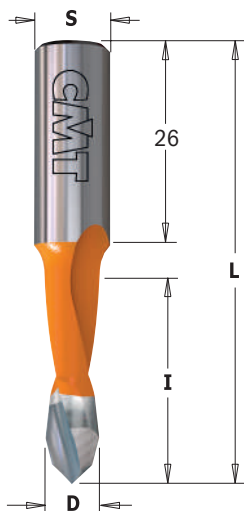

## 313.41/42 XTREME

CARBIDE TIPPED LONG LIFE T2 RH LH

ORDER NO. Right-hand rotation	ORDER NO. Left-hand rotation		D inches	D mm	I mm	L mm	S mm
313.050.41	313.050.42	50	5	27	57.5	10x26	
313.080.41	313.080.42	50	5/16	7.94	27	57.5	10x26

For panels 20mm maximum in thickness

## 314.41/42 XTREME

ORDER NO. Right-hand rotation	ORDER NO. Left-hand rotation		D inches	D mm	I mm	L mm	S mm
314.050.41	314.050.42	50	5	35	70	10x26	
314.080.41	314.080.42	50	5/16	7.94	35	70	10x26

For panels 30mm maximum in thickness

### TECHNICAL DETAILS:

- Super-strength steel.
- Spiral portion coated with orange or black P.T.F.E.
- Extra-fine micrograin carbide spiral portion with centre point.
- T.C.T. head with precision balanced centre point.
- 2 precision ground cutting edges [T2].
- Double angle.
- 2 spiral flutes.
- Parallel shank with driving flat and length adjusting screw.

**APPLICATION:** for drilling through holes in solid wood, wood derivatives and laminates. For use on boring machines equipped with adaptors and/or chucks.

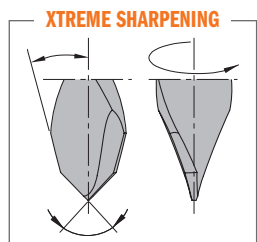
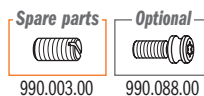

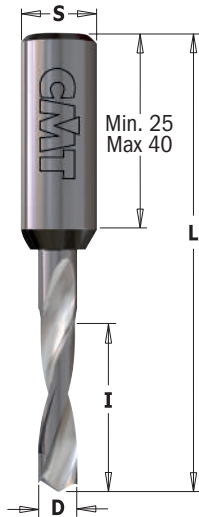

## 310.21/22 XTREME

SOLID CARBIDE LONG LIFE T2 V2 RH LH

ORDER NO. Right-hand rotation	ORDER NO. Left-hand rotation		D inches	D mm	I mm	L mm	S mm
310.020.21	310.020.22	50		2	12	57.5	10x27
310.030.21	310.030.22	50		3	18	57.5	10x25
310.040.21	310.040.22	50		4	20	57.5	10x27
310.050.21	310.050.22	50		5	22	57.5	10x27
310.060.21	310.060.22	50		6	22	57.5	10x27
310.064.21	310.064.22	50	1/4	6.35	22	57.5	10x27
310.080.21	310.080.22	50	5/16	7.94	22	57.5	10x27

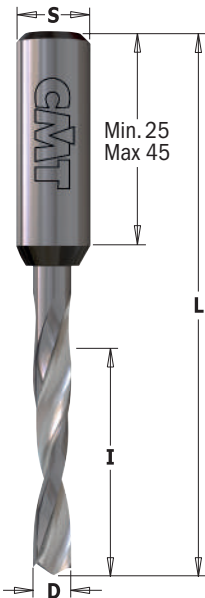
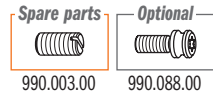

## 311.21/22 XTREME

SOLID CARBIDE LONG LIFE T2 V2 RH LH

ORDER NO. Right-hand rotation	ORDER NO. Left-hand rotation		D inches	D mm	I mm	L mm	S mm
311.013.20*		50		1.3	5	70	10x45
311.020.21	311.020.22	50		2	12	70	10x40
311.030.21	311.030.22	50		3	18	70	10x42
311.040.21	311.040.22	50		4	30	70	10x28
311.050.21	311.050.22	50		5	30	70	10x30
311.060.21	311.060.22	50		6	30	70	10x27
311.064.21	311.064.22	50	1/4	6.35	30	70	10x30
311.080.21	311.080.22	50	5/16	7.94	35	70	10x25

\* Boring bit for panel preboring.  
Suitable for both right-hand and left-hand rotation.

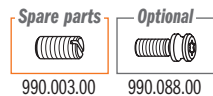

### TECHNICAL DETAILS:

- Premium quality super-strength steel shank.
- High quality S.T.C. body.
- Centre point.
- 2 cutting edges [T2].
- 2 spiral flutes.
- 2 curved, negatively ground spurs [V2].
- Parallel shank with driving flat and adjustable screw length.

**APPLICATION:** for drilling blind holes in solid wood, wood derivatives and laminates.  
For use on boring machines equipped with adaptors and/or with chucks

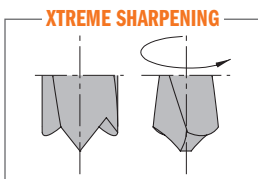

## Perfect for all materials and long-lasting performance!

CMT announces the new series of solid carbide boring bits, now available from their extensive industrial line. These bits are entirely made of premium quality super micrograin carbide from CERATIZIT® in Luxembourg.

The entire series offers several design features:

- the unique tip has curved, negatively ground spurs to produce exceptionally clear bores with no rough-edges.
- Centre point balanced;
- the cylindrical head is bigger than traditional tips and is extremely resistant to prolonged use.

It lasts longer between sharpenings;

- the plunge edge runs all the way to the centre of the bit to reduce drilling resistance and increase production speed;
- the solid carbide construction guarantees an almost infinite number of resharpenings, and since it is a solid unit of carbide, it offers extra safety features;
- ideal for hardwood and difficult composites such as particle boards, MDF and veneered wood.
- excellent performance on high-speed boring units and CNC routers.

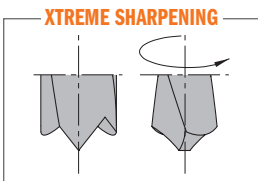
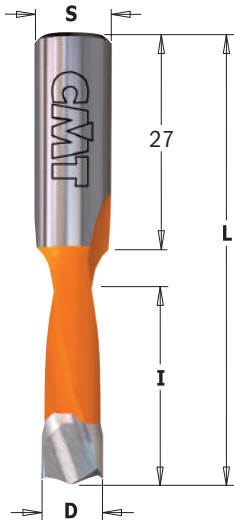

## 310.41/42 XTREME

CARBIDE TIPPED LONG LIFE T2 V2 RH LH

ORDER NO. Right-hand rotation	ORDER NO. Left-hand rotation		D inches	D mm	I mm	L mm	S mm
310.050.41	310.050.42	50		5	27	57.5	10x27
310.060.41	310.060.42	50		6	27	57.5	10x27
310.070.41	310.070.42	50		7	27	57.5	10x27
310.080.41	310.080.42	50	5/16	7.94	27	57.5	10x27
310.090.41	310.090.42	50		9	27	57.5	10x27
310.100.41	310.100.42	50		10	27	57.5	10x27

### TECHNICAL DETAILS:

- Premium quality super-strength steel.
- Orange or black P.T.F.E. coating.
- High quality extra-fine micrograin carbide body.
- 2 cutting edges [T2].
- Double angle.
- 2 spiral flutes.
- 2 curved, negatively ground spurs [V2]
- Parallel shank with driving flat and adjustable screw length.

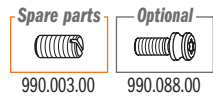

**APPLICATION:** for drilling blind holes in solid wood, wood derivatives and laminates. For use on boring machines equipped with adaptors and/or chucks.

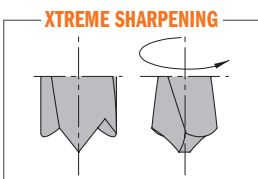
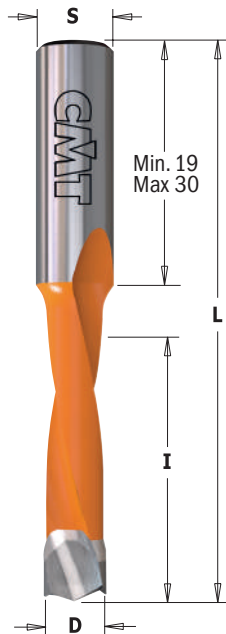

## 311.41/42 XTREME

CARBIDE TIPPED LONG LIFE T2 V2 RH LH

ORDER NO. Right-hand rotation	ORDER NO. Left-hand rotation		D inches	D mm	I mm	L mm	S mm
311.050.41	311.050.42	50		5	35	70	10x30
311.060.41	311.060.42	50		6	35	70	10x30
311.070.41	311.070.42	50		7	35	70	10x30
311.080.41	311.080.42	50	5/16	7.94	35	70	10x30
311.580.41	311.580.42	50	5/16	7.94	45	70	10x19
311.090.41	311.090.42	50		9	35	70	10x30
311.100.41	311.100.42	50		10	35	70	10x30
<b>new</b> 311.120.41	311.120.42	50		12	35	70	10x30

### TECHNICAL DETAILS:

- Premium quality super-strength steel.
- High quality extra-fine micrograin carbide body.
- Orange or black P.T.F.E. coating.
- 2 cutting edges [T2].
- 2 curved, negatively ground spurs [V2].
- 2 spiral flutes.
- Parallel shank with driving flat and adjustable screw length.

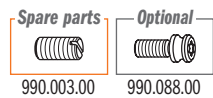

**APPLICATION:** for drilling blind holes in solid wood, wood derivatives, plastics and laminates. For use on boring machines equipped with adaptors and/or chucks.

\* Drill bits designed to fit HÄFELE® one-piece lxconnect SC 8/60 spreading connector.

## 2 Flute Dowel Drills

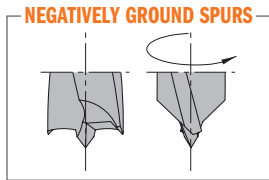
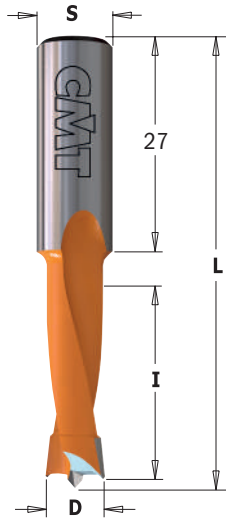

### 310

**CARBIDE TIPPED** **T2** **V2** **RH** **LH**

ORDER NO. Right-hand rotation	ORDER NO. Left-hand rotation		D inches	D mm	I mm	L mm	S mm
310.040.11	310.040.12	50	5/32	4	27	57.5	10x27
310.045.11	310.045.12	50		4.5	27	57.5	10x27
310.047.11	310.047.12	50	3/16	4.76	27	57.5	10x27
310.050.11	310.050.12	50		5	27	57.5	10x27
310.060.11	310.060.12	50		6	27	57.5	10x27
310.064.11	310.064.12	50	1/4	6.35	27	57.5	10x27
310.065.11	310.065.12	50		6.5	27	57.5	10x27
310.070.11	310.070.12	50		7	27	57.5	10x27
310.080.11	310.080.12	50	5/16	7.94	27	57.5	10x27
310.082.11	310.082.12	50		8.2	27	57.5	10x27
310.090.11	310.090.12	50		9	27	57.5	10x27
310.095.11	310.095.12	50	3/8	9.52	27	57.5	10x27
310.100.11	310.100.12	50		10	27	57.5	10x27
310.110.11	310.110.12	10		11	27	57.5	10x27
310.120.11	310.120.12	10		12	27	57.5	10x27
310.127.11	310.127.12	10	1/2	12.7	27	57.5	10x27
310.130.11	310.130.12	10		13	27	57.5	10x27
310.140.11	310.140.12	10		14	27	57.5	10x27
310.150.11	310.150.12	10		15	27	57.5	10x27
310.160.11	310.160.12	10		16	27	57.5	10x27

**Spare parts** 990.003.00 **Optional** 990.088.00

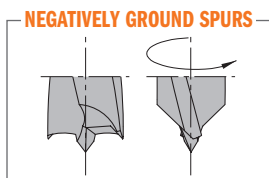
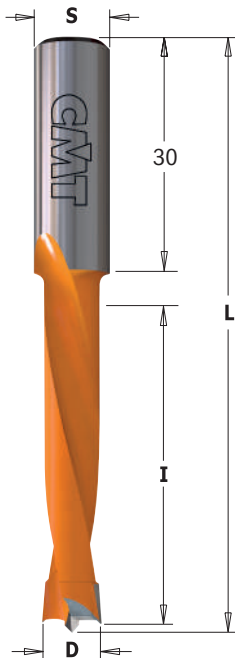

### 362

**CARBIDE TIPPED** **T2** **V2** **RH** **LH**

ORDER NO. Right-hand rotation	ORDER NO. Left-hand rotation		D inches	D mm	I mm	L mm	S mm
362.050.11	362.050.12	50		5	44	77	10x30
362.060.11	362.060.12	50		6	44	77	10x30
362.070.11	362.070.12	50		7	44	77	10x30
362.080.11	362.080.12	50	5/16	7.94	44	77	10x30
362.100.11	362.100.12	50		10	44	77	10x30
362.120.11	362.120.12	10		12	44	77	10x30

**TECHNICAL DETAILS:**

- Super-strength steel.
- Spiral portion coated with orange or black P.T.F.E.
- T.C.T. head with precision balanced centre point.
- 2 T.C.T. precision ground cutting edges [T2].
- 2 negatively ground spurs [V2].
- 2 spiral flutes.
- Parallel shank with driving flat and length adjusting screw.

**Spare parts** 990.003.00 **Optional** 990.088.00

**APPLICATION:** used on boring machines equipped with adapters or chucks. Used to drill blind holes in solid wood, wood composites, plastic and laminated materials.



## 2 Flute Dowel Drills

**CARBIDE TIPPED** **T2** **V2** **RH** **LH**

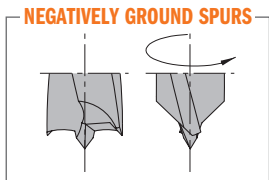
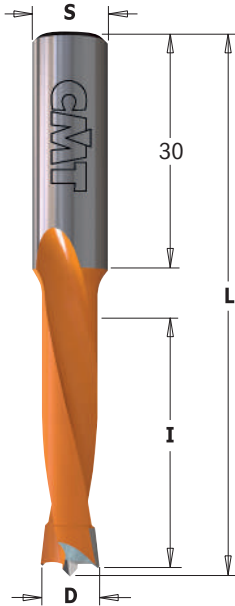

**TECHNICAL DETAILS:**

- Super-strength steel.
- Spiral portion coated with orange or black P.T.F.E.
- T.C.T. head with precision balanced centre point.
- 2 T.C.T. precision ground cutting edges [T2].
- 2 negatively ground spurs [V2]. - 2 spiral flutes.
- Parallel shank with driving flat and length adjusting screw.

### 311

ORDER NO. Right-hand rotation	ORDER NO. Left-hand rotation		D inches	D mm	I mm	L mm	S mm
311.040.11	311.040.12	50	5/32	4	35	70	10x30
311.045.11	311.045.12	50		4.5	35	70	10x30
311.047.11	311.047.12	50	3/16	4.76	35	70	10x30
311.050.11	311.050.12	50		5	35	70	10x30
311.051.11	311.051.12	50		5.1	35	70	10x30
311.052.11	311.052.12	50		5.2	35	70	10x30
311.055.11	311.055.12	50	7/32	5.55	35	70	10x30
311.060.11	311.060.12	50		6	35	70	10x30
311.064.11	311.064.12	50	1/4	6.35	35	70	10x30
311.065.11	311.065.12	50		6.5	35	70	10x30
311.070.11	311.070.12	50		7	35	70	10x30
311.080.11	311.080.12	50	5/16	7.94	35	70	10x30
311.082.11	311.082.12	50		8.2	35	70	10x30
311.090.11	311.090.12	50		9	35	70	10x30
311.095.11	311.095.12	50	3/8	9.52	35	70	10x30
311.100.11	311.100.12	50		10	35	70	10x30
311.110.11	311.110.12	10		11	35	70	10x30
311.111.11	311.111.12	10	7/16	11.1	35	70	10x30
311.120.11	311.120.12	10		12	35	70	10x30
311.127.11	311.127.12	10	1/2	12.7	35	70	10x30
311.130.11	311.130.12	10		13	35	70	10x30
311.140.11	311.140.12	10		14	35	70	10x30
311.150.11	311.150.12	10		15	35	70	10x30
311.160.11	311.160.12	10		16	35	70	10x30

**APPLICATION:** used on boring machines equipped with adapters or chucks. Used to drill blind holes in solid wood, wood composites, plastic and laminated materials.

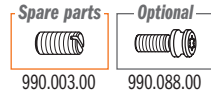

## Dowel Drills with Countersink

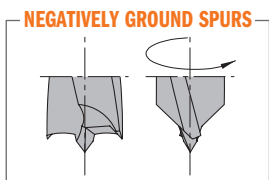
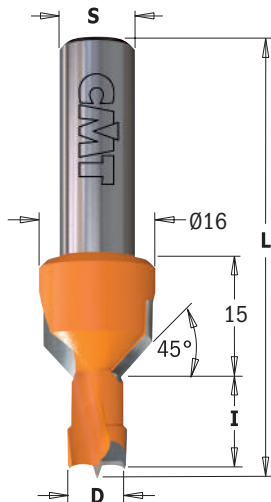

### 376-377

**CARBIDE TIPPED** **T2** **V2** **RH** **LH**

ORDER NO. Right-hand rotation	ORDER NO. Left-hand rotation		D inches	D mm	I mm	L mm	S mm
376.080.11	376.080.12	10	5/16	7.94	12	57.5	10
376.081.11	376.081.12	10	5/16	7.94	15	57.5	10
376.082.11	376.082.12	10	5/16	7.94	20	57.5	10
376.100.11	376.100.12	10		10	12	57.5	10
376.101.11	376.101.12	10		10	15	57.5	10
376.102.11	376.102.12	10		10	20	57.5	10
377.080.11	377.080.12	10	5/16	7.94	12	70	10
377.081.11	377.081.12	10	5/16	7.94	15	70	10
377.082.11	377.082.12	10	5/16	7.94	20	70	10
377.100.11	377.100.12	10		10	12	70	10
377.101.11	377.101.12	10		10	15	70	10
377.102.11	377.102.12	10		10	20	70	10

**TECHNICAL DETAILS:**

- Super-strength steel.
- Spiral portion coated with orange or black P.T.F.E.
- T.C.T. head with precision balanced centre point.
- 2 precision ground cutting edges [T2]. - 2 ground spurs [V2]. - 2 spiral flutes.
- Parallel shank with driving flat and length adjusting screw.

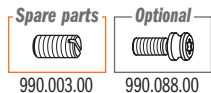

**APPLICATION:** used for drilling and countersinking in solid wood, wood composites, plastic and laminated materials. Suitable for high performance speed on boring machines equipped with adapters or chucks.

# 4 Flute Dowel Drills

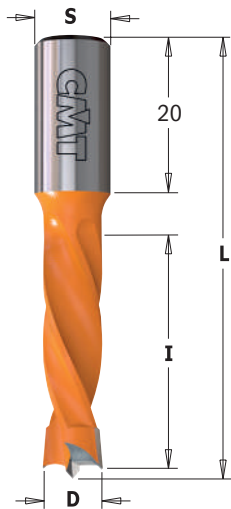

## 308

**CARBIDE TIPPED** **T2** **V2** **RH** **LH**

ORDER NO. Right-hand rotation	ORDER NO. Left-hand rotation		D inches	D mm	I mm	L mm	S mm
<b>308.050.11</b>	<b>308.050.12</b>	50		5	30	57.5	10x20
<b>308.060.11</b>	<b>308.060.12</b>	50		6	30	57.5	10x20
<b>308.080.11</b>	<b>308.080.12</b>	50	5/16	7.94	30	57.5	10x20
<b>308.100.11</b>	<b>308.100.12</b>	50		10	30	57.5	10x20

### NEGATIVELY GROUND SPURS

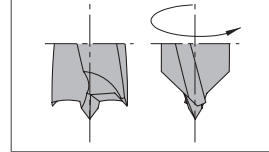

**Spare parts** 990.003.00 **Optional** 990.088.00

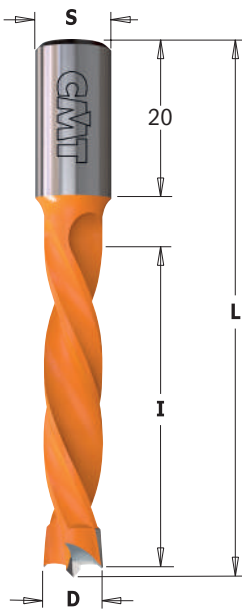

## 309

**CARBIDE TIPPED** **T2** **V2** **RH** **LH**

ORDER NO. Right-hand rotation	ORDER NO. Left-hand rotation		D inches	D mm	I mm	L mm	S mm
<b>309.040.11</b>	<b>309.040.12</b>	50	5/32	4	43	70	10x20
<b>309.050.11</b>	<b>309.050.12</b>	50		5	43	70	10x20
<b>309.060.11</b>	<b>309.060.12</b>	50		6	43	70	10x20
<b>309.064.11</b>	<b>309.064.12</b>	50	1/4	6.35	43	70	10x20
<b>309.070.11</b>	<b>309.070.12</b>	50		7	43	70	10x20
<b>309.075.11</b>	<b>309.075.12</b>	50		7.5	43	70	10x20
<b>309.080.11</b>	<b>309.080.12</b>	50	5/16	7.94	43	70	10x20
<b>309.090.11</b>	<b>309.090.12</b>	50		9	43	70	10x20
<b>309.095.11</b>	<b>309.095.12</b>	50	3/8	9.52	43	70	10x20
<b>309.100.11</b>	<b>309.100.12</b>	50		10	43	70	10x20
<b>309.110.11</b>	<b>309.110.12</b>	10		11	43	70	10x20
<b>309.120.11</b>	<b>309.120.12</b>	10		12	43	70	10x20
<b>309.127.11</b>	<b>309.127.12</b>	10	1/2	12.7	43	70	10x20
<b>309.130.11</b>	<b>309.130.12</b>	10		13	43	70	10x20
<b>309.140.11</b>	<b>309.140.12</b>	10		14	43	70	10x20
<b>309.150.11</b>	<b>309.150.12</b>	10		15	43	70	10x20
<b>309.160.11</b>	<b>309.160.12</b>	10		16	43	70	10x20

### TECHNICAL DETAILS:

- Super-strength steel.
- Cutter portion coated with black or orange P.T.F.E.
- T.C.T. head with precision balanced centre point.
- 2 T.C.T. precision ground cutting edges [T2].
- Negatively ground spurs [V2].
- 4 spiral flutes.
- Parallel shank with driving flat and length adjusting screw.

**Spare parts** 990.003.00 **Optional** 990.088.00

**APPLICATION:** used on boring machines equipped with adapters or chucks. Used to drill blind holes in solid wood, wood composites, plastic and laminated materials.

### NEGATIVELY GROUND SPURS

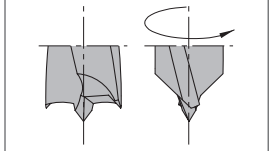

# 4 Flute Dowel Drills

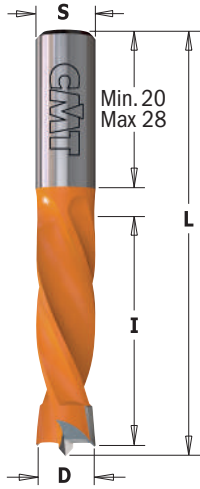

## 306

CARBIDE TIPPED SOLID CARBIDE T2 V2 RH LH

ORDER NO. Right-hand rotation	ORDER NO. Left-hand rotation		D inches	D mm	I mm	L mm	S mm
306.030.21 •		50		3	18	55.5	8x28
306.050.11	306.050.12	50		5	30	55.5	8x20
306.055.11	306.055.12	50	7/32	5.55	30	55.5	8x20
306.060.11	306.060.12	50		6	30	55.5	8x20
306.064.11	306.064.12	50	1/4	6.35	30	55.5	8x20
306.070.11	306.070.12	50		7	30	55.5	8x20
306.080.11	306.080.12	50	5/16	7.94	30	55.5	8x20
306.090.11	306.090.12	50		9	30	55.5	8x20
306.100.11	306.100.12	50		10	30	55.5	8x20
306.120.11	306.120.12	50		12	30	55.5	8x20

• Solid Carbide

AVAILABLE ON REQUEST

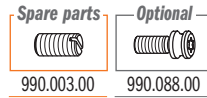

**NEGATIVELY GROUND SPURS**

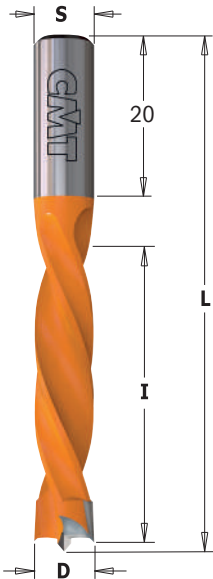
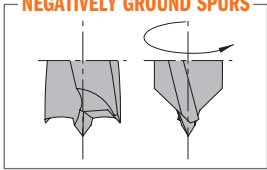

## 307

CARBIDE TIPPED T2 V2 RH LH

ORDER NO. Right-hand rotation	ORDER NO. Left-hand rotation		D inches	D mm	I mm	L mm	S mm
307.050.11	307.050.12	50		5	40	67	8x20
307.055.11	307.055.12	50	7/32	5.55	40	67	8x20
307.060.11	307.060.12	50		6	40	67	8x20
307.064.11	307.064.12	50	1/4	6.35	40	67	8x20
307.070.11	307.070.12	50		7	40	67	8x20
307.080.11	307.080.12	50	5/16	7.94	40	67	8x20
307.090.11	307.090.12	50		9	40	67	8x20
307.095.11	307.095.12	50	3/8	9.52	40	67	8x20
307.100.11	307.100.12	50		10	40	67	8x20
307.120.11	307.120.12	10		12	40	67	8x20

**TECHNICAL DETAILS:**

- Super-strength steel.
- Cutter portion coated with black or orange P.T.F.E.
- T.C.T. head with precision balanced centre point.
- 2 T.C.T. precision ground cutting edges [T2].
- Negatively ground spurs [V2].
- 4 spiral flutes.
- Parallel shank with driving flat and length adjusting screw.

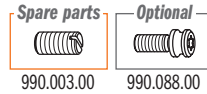

**NEGATIVELY GROUND SPURS**

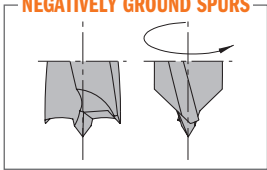

**APPLICATION:** used on boring machines equipped with adapters or chucks. Used to drill blind holes in solid wood, wood composites, plastic and laminated materials.

AVAILABLE ON REQUEST

# 4 Flute Dowel Drills

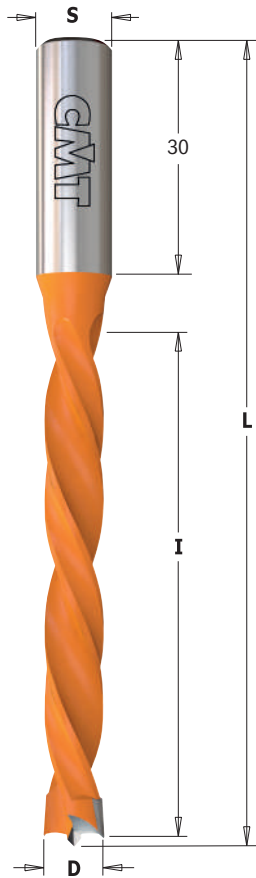

## 372

**CARBIDE TIPPED** **T2** **V2** **RH** **LH**

ORDER NO. Right-hand rotation	ORDER NO. Left-hand rotation		D inches	D mm	I mm	L mm	S mm
<b>372.050.11</b>	<b>372.050.12</b>	10		5	65	105	10x30
<b>372.060.11</b>	<b>372.060.12</b>	10		6	65	105	10x30
<b>372.080.11</b>	<b>372.080.12</b>	10	5/16	7.94	65	105	10x30
<b>372.100.11</b>	<b>372.100.12</b>	10		10	65	105	10x30
<b>372.120.11</b>	<b>372.120.12</b>	10		12	65	105	10x30

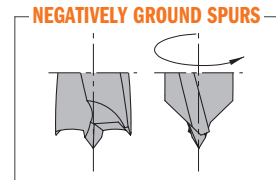

**Spare parts** 990.003.00  
**Optional** 990.088.00

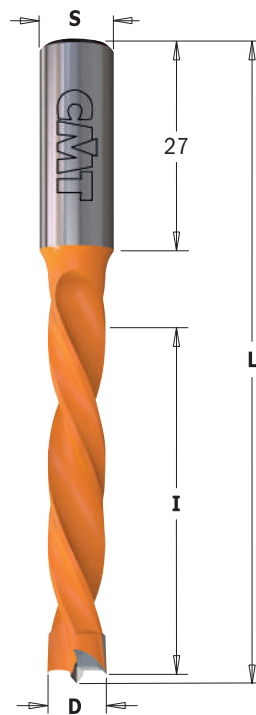

## 373

**CARBIDE TIPPED** **T2** **V2** **RH** **LH**

ORDER NO. Right-hand rotation	ORDER NO. Left-hand rotation		D inches	D mm	I mm	L mm	S mm
<b>373.050.11</b>	<b>373.050.12</b>	50		5	50	85	10x27
<b>373.060.11</b>	<b>373.060.12</b>	50		6	50	85	10x27
<b>373.080.11</b>	<b>373.080.12</b>	50	5/16	7.94	50	85	10x27
<b>373.100.11</b>	<b>373.100.12</b>	50		10	50	85	10x27
<b>373.120.11</b>	<b>373.120.12</b>	10		12	50	85	10x27

**TECHNICAL DETAILS:**

- Super-strength steel.
- Cutter portion coated with black or orange P.T.F.E.
- T.C.T. head with precision balanced centre point.
- 2 T.C.T. precision ground cutting edges [T2].
- Negatively ground spurs [V2].
- 4 spiral flutes.
- Parallel shank with driving flat and length adjusting screw.

**Spare parts** 990.003.00  
**Optional** 990.088.00

**APPLICATION:** used on boring machines equipped with adapters or chucks. Used to drill blind holes in solid wood, wood composites, plastic and laminated materials.

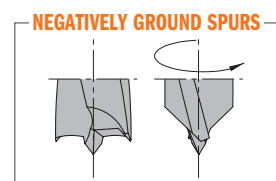



# Solid Carbide Twist Drills

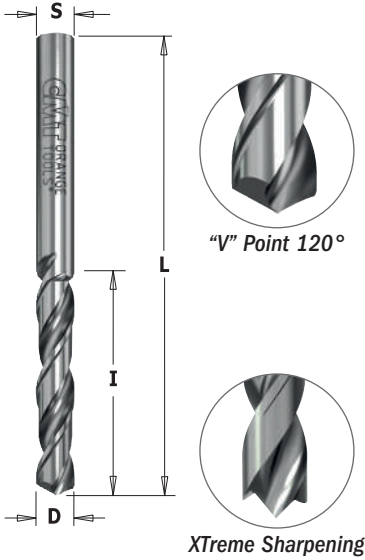

## 363

SOLID CARBIDE LONG LIFE T2 RH LH

ORDER NO. Right-hand rotation	ORDER NO. Left-hand rotation		D mm	I mm	L mm	S mm
<b>"V" POINT 120° SHARPENING</b>						
363.020.11	363.020.12	50	2	25	50	2
363.025.11	363.025.12	50	2.5	27	55	2.5
363.030.11	363.030.12	50	3	27	55	3
363.032.11	363.032.12	50	3.2	27	55	3.2
363.035.11	363.035.12	50	3.5	27	55	3.5
363.040.11	363.040.12	50	4	27	55	4
363.045.11	363.045.12	50	4.5	28	60	4.5
363.050.11	363.050.12	50	5	28	60	5
<b>X-TREME NEW DOWN CUT ROUND SHARPENING</b>						
363.025.21	363.025.22	50	2.5	27	55	2.5
363.030.21	363.030.22	50	3	27	55	3
363.040.21	363.040.22	50	4	27	55	4
363.050.21	363.050.22	50	5	28	60	5

For use with the following items: **364-365**

**TECHNICAL DETAILS:**

- Premium quality S.T.C.
- 2 precision ground cutting edges [T2].
- 2 spiral flutes.
- Common shank and drilling diameter (S=D).

**APPLICATION:**

for drilling through holes in solid wood, wood derivatives and laminates. For use on boring machines equipped with adapters and/or chucks.

# Adapters & Bushings for Twist Drills

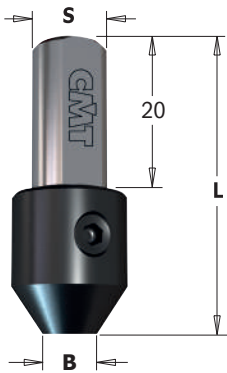

## 364

ORDER NO.		B mm	L mm	S mm
364.020.00	10	2	38	10x20
364.025.00	10	2.5	38	10x20
364.030.00	10	3	38	10x20
364.032.00	10	3.2	38	10x20
364.035.00	10	3.5	38	10x20
364.040.00	10	4	38	10x20
364.045.00	10	4.5	38	10x20
364.050.00	10	5	38	10x20

For use with the following items: **363**

Spare parts	
990.001.00	991.062.00

**TECHNICAL DETAILS:**

- Super-strength steel.
- Quick and secure assembly on twist drills.
- Precision relief.
- Parallel shank with driving flat.

**APPLICATION:**

for use with twist drills with common shank and bushing diameter. For use on boring machines equipped with adapters and/or chucks.

## 2 Flute Dowel Drills for Through Holes

**CARBIDE TIPPED** **T2** **RH** **LH**

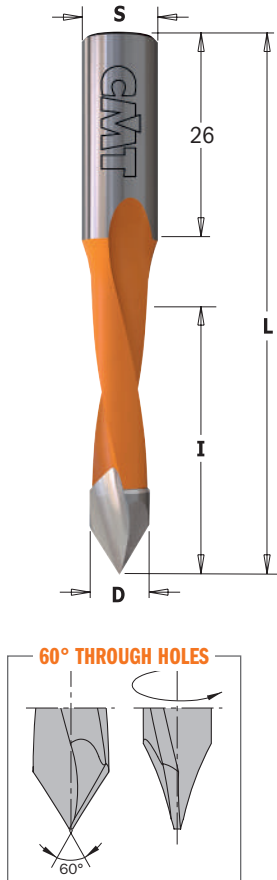

### 313 FOR PANELS WITH MAXIMUM 20MM IN THICKNESS

ORDER NO. Right-hand rotation	ORDER NO. Left-hand rotation		D inches	D mm	I mm	L mm	S mm
<b>313.050.11</b>	<b>313.050.12</b>	50		5	27	57.5	10x26
<b>313.060.11</b>	<b>313.060.12</b>	50		6	27	57.5	10x26
<b>313.080.11</b>	<b>313.080.12</b>	50	5/16	7.94	27	57.5	10x26
<b>313.100.11</b>	<b>313.100.12</b>	50		10	27	57.5	10x26

### 314 FOR PANELS WITH MAXIMUM 25-30MM IN THICKNESS

ORDER NO. Right-hand rotation	ORDER NO. Left-hand rotation		D inches	D mm	I mm	L mm	S mm
<b>314.040.11</b>	<b>314.040.12</b>	50	5/32	4	30	70	10x26
<b>314.047.11</b>	<b>314.047.12</b>	50	3/16	4.76	35	70	10x26
<b>314.050.11</b>	<b>314.050.12</b>	50		5	35	70	10x26
<b>314.055.11</b>	<b>314.055.12</b>	50	7/32	5.55	35	70	10x26
<b>314.060.11</b>	<b>314.060.12</b>	50		6	35	70	10x26
<b>314.064.11</b>	<b>314.064.12</b>	50	1/4	6.35	35	70	10x26
<b>314.070.11</b>	<b>314.070.12</b>	50		7	35	70	10x26
<b>314.080.11</b>	<b>314.080.12</b>	50	5/16	7.94	35	70	10x26
<b>314.090.11</b>	<b>314.090.12</b>	50		9	35	70	10x26
<b>314.095.11</b>	<b>314.095.12</b>	50	3/8	9.52	35	70	10x26
<b>314.100.11</b>	<b>314.100.12</b>	50		10	35	70	10x26
<b>314.120.11</b>	<b>314.120.12</b>	10		12	35	70	10x26
<b>314.127.11</b>	<b>314.127.12</b>	10	1/2	12.7	35	70	10x26

### 366 FOR PANELS WITH MAXIMUM 30-40MM IN THICKNESS

ORDER NO. Right-hand rotation	ORDER NO. Left-hand rotation		D inches	D mm	I mm	L mm	S mm
<b>366.050.11</b>	<b>366.050.12</b>	50		5	44	77	10x26
<b>366.060.11</b>	<b>366.060.12</b>	50		6	44	77	10x26
<b>366.080.11</b>	<b>366.080.12</b>	50	5/16	7.94	44	77	10x26
<b>366.100.11</b>	<b>366.100.12</b>	50		10	44	77	10x26
<b>366.120.11</b>	<b>366.120.12</b>	10		12	44	77	10x26

#### TECHNICAL DETAILS:

- Super-strength steel.
- Spiral portion coated with orange or black P.T.F.E.
- T.C.T. head with precision balanced centre point.
- 2 precision ground cutting edges [T2].
- 2 spiral flutes.
- Parallel shank with driving flat and length adjusting screw.

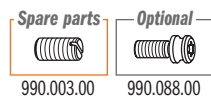

#### APPLICATION: used on boring machines and dowel drilling devices.

Use for drilling through holes in solid wood, wood composites, plastic and laminated materials.

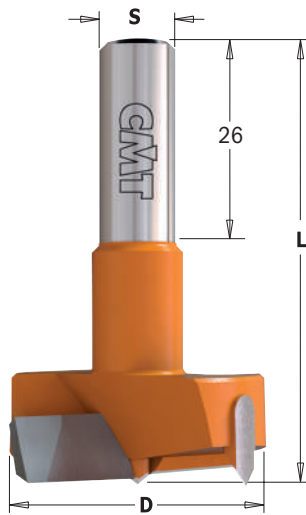

New construction with 1mm centre point

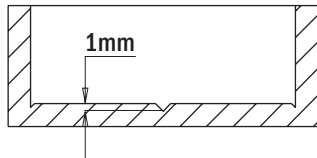

## 317

CARBIDE TIPPED T2 V2 RH LH

ORDER NO. Right-hand rotation	ORDER NO. Left-hand rotation		D mm	L mm	S mm
317.140.11	317.140.12	10	14	57.5	10x26
317.150.11	317.150.12	10	15	57.5	10x26
317.160.11	317.160.12	10	16	57.5	10x26
317.170.11	317.170.12	10	17	57.5	10x26
317.180.11	317.180.12	10	18	57.5	10x26
317.190.11	317.190.12	10	19	57.5	10x26
317.200.11	317.200.12	10	20	57.5	10x26
317.220.11	317.220.12	10	22	57.5	10x26
317.240.11	317.240.12	10	24	57.5	10x26
317.250.11	317.250.12	10	25	57.5	10x26
317.260.11	317.260.12	10	26	57.5	10x26
317.280.11	317.280.12	10	28	57.5	10x26
317.300.11	317.300.12	10	30	57.5	10x26
317.320.11	317.320.12	10	32	57.5	10x26
317.350.11	317.350.12	10	35	57.5	10x26
317.380.11	317.380.12	10	38	57.5	10x26
317.400.11	317.400.12	10	40	57.5	10x26
317.450.11	317.450.12	10	45	57.5	10x26
317.500.11	317.500.12	10	50	57.5	10x26
317.550.11	317.550.12	10	55	57.5	10x26
317.600.11	317.600.12	10	60	57.5	10x26

## 369

ORDER NO. Right-hand rotation	ORDER NO. Left-hand rotation		D mm	L mm	S mm
369.140.11	369.140.12	10	14	70	10x26
369.150.11	369.150.12	10	15	70	10x26
369.160.11	369.160.12	10	16	70	10x26
369.180.11	369.180.12	10	18	70	10x26
369.200.11	369.200.12	10	20	70	10x26
369.220.11	369.220.12	10	22	70	10x26
369.250.11	369.250.12	10	25	70	10x26
369.260.11	369.260.12	10	26	70	10x26
369.300.11	369.300.12	10	30	70	10x26
369.350.11	369.350.12	10	35	70	10x26
369.400.11	369.400.12	10	40	70	10x26
369.450.11	369.450.12	10	45	70	10x26
369.500.11	369.500.12	10	50	70	10x26
369.550.11	369.550.12	10	55	70	10x26
369.600.11	369.600.12	10	60	70	10x26

### TECHNICAL DETAILS:

- Super-strength steel.
- Cutter portion coated with orange or black P.T.F.E.
- T.C.T. head with precision balanced centre point.
- 2 T.C.T. precision ground cutting edges [T2].
- 2 negatively ground spurs [V2].
- Parallel shank with driving flat and length adjusting screw.

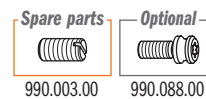

**APPLICATION: ideal for hinges.** Use on boring machines equipped with adapters or chucks. Use for drilling accurate and clean-cut blind holes in solid wood, wood composites, plastic and laminated materials.





# BITS FOR HAND POWER TOOLS

<b>PRODUCTS</b>	<b>PAGE</b>
Adjustable Countersink	302
Boring Bits with Parallel Shank	302
90° Countersink with Parallel Shank	302
Mortise Chisel Sets and Plug Cutters	303
Forstner Bits and Sets	304
Router Bits for DOMINO®	305
Rosette Cutters	305



© Brand names mentioned in CMT products are the property of their respective owners (see page 368)



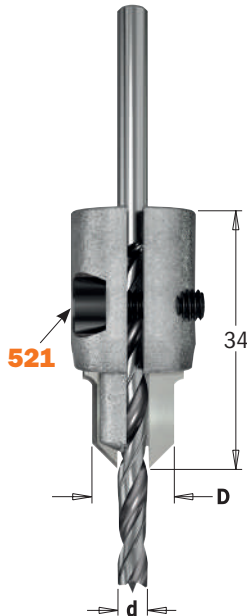

## 521.001

**CARBIDE TIPPED** **T2** **RH**

ORDER NO. Right-hand rotation		d mm	D mm
521.001.11	10	3 ~ 7	11 ~ 15

Spare parts

990.061.00	991.067.00

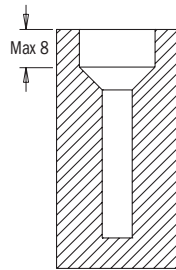

TWIST DRILLS	OVERALL DIAMETER
Ø3	Ø11
Ø4	Ø12
Ø5	Ø13
Ø6	Ø14
Ø7	Ø15

### TECHNICAL DETAILS:

- Super strength steel.
- 2 T.C.T. precision ground cutting edges [T2].
- Fastening screw for quick and easy drill bit change.

**APPLICATION:** for use with spiral bits featuring a parallel shank of equal dimension to countersink shank diameter. **Twist drill bit NOT included**

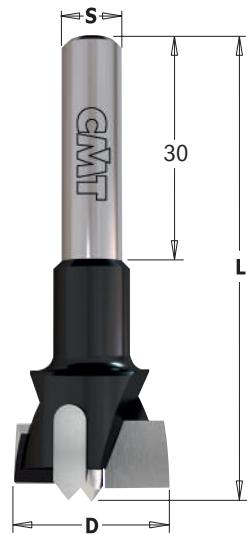

## Boring Bits with Parallel Shank

### 392

**CARBIDE TIPPED** **T2** **V2** **RH**

ORDER NO. Right-hand rotation		D mm	L inches	S inches
392.150.11	10	15	2-23/64	5/16
392.200.11	10	20	2-23/64	5/16
392.250.11	10	25	2-23/64	5/16
392.260.11	10	26	2-23/64	5/16
392.300.11	10	30	2-23/64	5/16
392.350.11	10	35	2-23/64	5/16
392.351.11	10	35	2-23/64	1/2
392.400.11	10	40	2-23/64	5/16

### TECHNICAL DETAILS:

- Super strength steel.
- T.C.T. precision balanced centre point.
- 2 T.C.T. precision ground cutting edges [T2].
- 2 T.C.T. negatively ground spurs [V2].

**APPLICATION:** for drilling blind holes in solid wood, wood derivatives and laminates. **Ideal for hinges.**

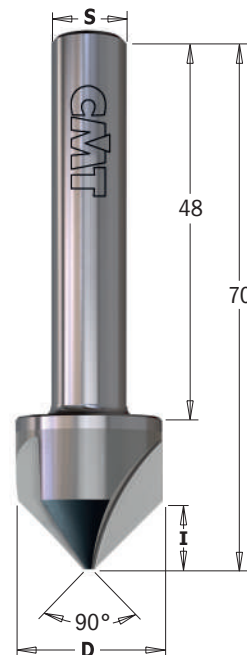

## 90° Solid Carbide Countersink with Parallel Shank

### 521

**SOLID CARBIDE** **T3** **RH**

ORDER NO. Right-hand rotation		D mm	I mm	L mm	S mm
521.002.11	10	19.5	9	70	10x48

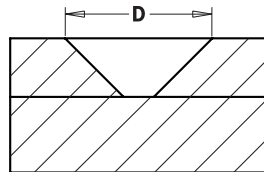

### TECHNICAL DETAILS:

- For making 90° countersink blind holes accepting flat-head fasteners that sit flush with the surface.
- 3 wear-resistant precision ground cutting edges providing a smooth finish on hardened materials.
- Solid carbide tool that is harder than cobalt steel, providing a longer tool life at higher speeds.
- Parallel shank to accommodate most drill chucks.
- Suitable for wood, wood-based, non-ferrous materials and metal.

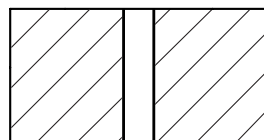

For drilling use bits  
serie **516** or **517**



**543**

**HSS T1 RH**

ORDER NO. Right-hand rotation	Box Qty	D		S	
		inches	mm	inches	mm
<b>543.064.51</b>	1	1/4	6.35	3/4	19
<b>543.079.51</b>	1	5/16	8	3/4	19
<b>543.095.51</b>	1	3/8	9.52	3/4	19
<b>543.127.51</b>	1	1/2	12.7	3/4	19
<b>543.158.51</b>	1	5/8	15.8	3/4	19
<b>543.190.51</b>	1	3/4	19	3/4	19

It's tough to beat the old faithful mortise and tenon joint for strength and accuracy, even with all the other joinery options in the world of woodworking. It isn't the easiest joint to make, but it surely helps to have the best quality tools in your shop. That's why we've added a new selection of chisel and bit sets in all the popular sizes 1/4" (6,35mm) to 3/4" (19mm) diameter.

These sets are for use on any standard drill press mortising attachment of mortising machines.



Sample of Chisel Mortiser

Plug Cutters



**529**

**SP RH**

ORDER NO. Right-hand rotation	Box Qty	d inches	D inches	L inches	S inches	T
<b>529.095.31</b>	5	3/8	49/64	5-1/2	1/2	4
<b>529.127.31</b>	5	1/2	61/64	5-1/2	1/2	4
<b>529.158.31</b>	5	5/8	1-7/64	5-1/2	1/2	4
<b>529.191.31</b>	5	3/4	1-7/32	5-1/2	1/2	4
<b>529.222.31</b>	5	7/8	1-11/32	5-1/2	1/2	4
<b>529.254.31</b>	5	1	1-15/32	5-1/2	1/2	5
<b>529.317.31</b>	5	1-1/4	1-19/32	5-1/2	1/2	5
<b>529.349.31</b>	2	1-3/8	1-27/32	6-5/16	5/8	6
<b>529.381.31</b>	2	1-1/2	1-31/32	6-5/16	5/8	6
<b>529.413.31</b>	2	1-5/8	2-3/32	6-5/16	5/8	6
<b>529.445.31</b>	2	1-3/4	2-7/32	6-5/16	5/8	6
<b>529.508.31</b>	2	2	2-15/32	6-5/16	5/8	6

**TECHNICAL DETAILS:**

- SP steel.
- Long lasting cutting performance.
- 4 cutting edges.

**APPLICATION:** for drilling plugs in natural soft or medium-density woods.

D mm	D inches	Max RPM Softwood	Max RPM Hardwood
< Ø16	5/8	1000	500
< Ø40	1-37/64	500	300
> Ø40	1-37/64	200	150

# Forstner Bits

**SP T2 V2 RH**

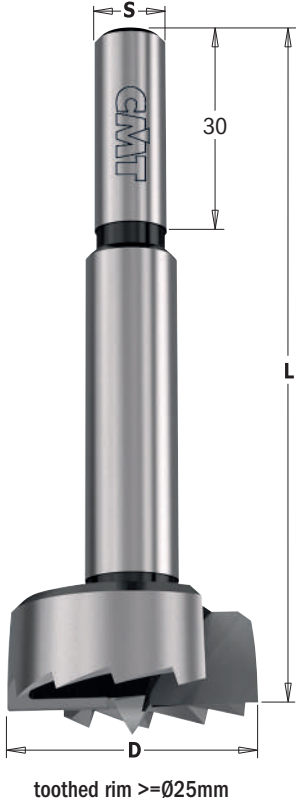

toothed rim  $\geq \varnothing 25\text{mm}$



standard rim  $< \varnothing 25\text{mm}$

## 537

ORDER NO.	Right-hand rotation	D	L	S
		inches	inches	inches
537.064.31	6	1/4	3-35/64	3/8
537.095.31	6	3/8	3-35/64	3/8
537.127.31	6	1/2	3-35/64	3/8
537.158.31	6	5/8	3-35/64	3/8
537.190.31	6	3/4	3-35/64	3/8
537.222.31	6	7/8	3-35/64	3/8
537.254.31	6	1	3-35/64	3/8
537.285.31	6	1-1/8	3-35/64	3/8
537.317.31	6	1-1/4	3-35/64	3/8
537.349.31	6	1-3/8	3-35/64	3/8
537.381.31	6	1-1/2	3-35/64	3/8
537.413.31	6	1-5/8	3-35/64	3/8
537.445.31	6	1-3/4	3-35/64	3/8
537.476.31	6	1-7/8	3-35/64	3/8
537.508.31	6	2	3-35/64	3/8
537.540.31	6	2-1/8	3-35/64	3/8
537.571.31	6	2-1/4	6-3/16	3/8
537.635.31	6	2-1/2	6-3/16	3/8
537.762.31	2	3	6-3/16	3/8
537.889.31	2	3-1/2	6-3/16	3/8
537.991.31	2	4	6-3/16	3/8
537.993.31	2	4-1/2	4-17/32	3/8

new new new new new new new

### TECHNICAL DETAILS:

- Long-lasting cutting performance.
- Super strength SP steel.
- Precision balanced centre point.
- 2 ground spurs [V2].
- 2 precision ground cutting edges [T2].

**APPLICATION:** for drilling precise flat bottom holes of any size in softwood. Create oval and arched openings at any angle. Create niches for the installation of brackets/straps, frames/grids.

ORDER NO.	Right-hand rotation	D	L	S
		mm	mm	mm
537.100.31	6	10	90	8
537.120.31	6	12	90	8
537.140.31	6	14	90	8
537.150.31	6	15	90	8
537.160.31	6	16	90	8
537.180.31	6	18	90	8
537.200.31	6	20	90	8
537.220.31	6	22	90	8
537.240.31	6	24	90	8
537.250.31	6	25	90	8
537.260.31	6	26	90	8
537.280.31	6	28	90	8
537.300.31	6	30	90	8
537.320.31	6	32	90	10
537.350.31	6	35	90	10
537.380.31	6	38	90	10
537.400.31	6	40	90	10
537.450.31	6	45	90	10
537.500.31	6	50	90	10
537.550.31	6	55	90	10
537.680.31	6	68	157	12.7
537.700.31	6	70	157	12.7
537.750.31	2	75	157	12.7
537.800.31	2	80	157	12.7
537.850.31	2	85	157	12.7
537.900.31	2	90	157	12.7
537.950.31	2	95	157	12.7
537.990.31	2	100	157	12.7

new new new new new new new new new new new new new

### STANDARD RIM AND TOOTHED RIM:

Standard rims provide better guidance but tend to overheat. To overcome heat the larger diameters ( $\geq \varnothing 25\text{mm}$ ) are designed with toothed rims.

# Forstner Bit Sets

We offer a wide range of Forstner bits in the most popular diameters to execute the cleanest holes in softwood. Drill ovals and arched openings at any angle for the installation of hinge parts. Available in 4, 5, 7, 12 and 16 bit sets.

- 537.000.04
- 537.000.05
- 537.000.07
- 537.000.12



**SP T2 V2 RH**

ORDER NO.	Right-hand rotation	DESCRIPTION	BIT DIAMETER	SHANK inches	SHANK mm
537.000.04	6	4 pcs. Router Bit Set in clamshell	$\varnothing 1/4'' - 1/2'' - 3/4'' - 1''$	$\varnothing 3/8$	
537.000.07	6	7 pcs. Router Bit Set in clamshell	$\varnothing 1/4'' - 3/8'' - 1/2'' - 5/8'' - 3/4'' - 7/8'' - 1''$	$\varnothing 3/8$	
537.000.16	8	16 pcs. Router Bit Set in plastic box	$\varnothing 1/4'' - 3/8'' - 1/2'' - 5/8'' - 3/4'' - 7/8'' - 1'' - 1-1/8'' - 1-1/4'' - 1-3/8'' - 1-1/2'' - 1-5/8'' - 1-3/4'' - 1-7/8'' - 2'' - 2-1/8''$	$\varnothing 3/8$	
537.000.05	6	5 pcs. Router Bit Set in clamshell	$\varnothing 15-20-25-30-35\text{mm}$		$\varnothing 8-10$
537.000.12	6	12 pcs. Router Bit Set in clamshell	$\varnothing 10-12-14-15-16-18-20-22-25-26-30-35\text{mm}$		$\varnothing 8-10$



**TECHNICAL DETAILS:**

- Premium quality super-strength steel.
- Black P.T.F.E. coating.
- S.T.C. head.
- No lateral spurs.
- 2 cutting edges [T2].
- 2 spiral flutes.

**APPLICATION:** for use on "DOMINO® machines to rout slots for hinges.

**380**

**CARBIDE TIPPED** **SOLID CARBIDE** **T2** **RH**

ORDER NO. Right-hand rotation		D mm	I mm	L mm	S mm	FESTOOL®
<b>380.040.11</b> •	10	4	11	38	M6x0,75	DF500
<b>380.050.11</b>	10	5	20	49	M6x0,75	DF500
<b>380.060.11</b>	10	6	28	49	M6x0,75	DF500
<b>380.080.11</b>	10	8	28	49	M6x0,75	DF500
<b>380.100.11</b>	10	10	28	49	M6x0,75	DF500
<b>380.081.11</b>	10	8	50	90	M8x1	DF700
<b>380.101.11</b>	10	10	70	90	M8x1	DF700
<b>380.121.11</b>	10	12	70	90	M8x1	DF700
<b>380.141.11</b>	10	14	70	90	M8x1	DF700

• Solid Carbide

Rosette Cutters



**531**

**CARBIDE TIPPED** **T2** **RH**

ORDER NO. Right-hand rotation		D inches	L inches	S inches	MAX RPM
<b>531.541</b>	10	2-1/8	2-57/64	3/8	1500
<b>531.542</b>	10	2-1/8	2-13/16	3/8	1500
<b>531.543</b>	10	2-1/8	2-21/32	3/8	1500
<b>531.544</b>	10	2-1/8	2-27/32	3/8	1500
<b>531.701</b>	5	2-3/4	3-1/64	3/8	1500
<b>531.702</b>	5	2-3/4	2-29/32	3/8	1000

**TECHNICAL DETAILS:**

- Super strength steel.
- 2 T.C.T. precision ground cutting edges [T2].
- Parallel hexagonal shank.
- Right-hand rotation (RH).



**APPLICATION:** for use on drill presses and low speed power tools (see table above for max RPM). We recommend securely clamping your workpiece throughout drilling operations.

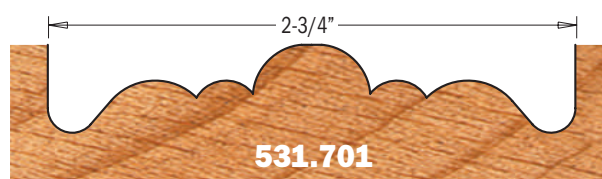
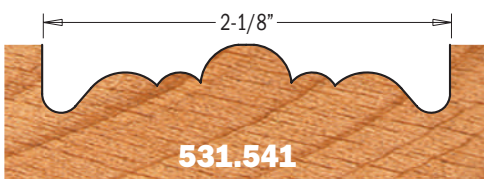

Drawing is 1:1 scale





# CMT XTREME FAST AND PUSH&LOCK SYSTEMS: NEXT GENERATION HOLE SAW



These hole saws, equipped with the new **XTREME FAST** system, have been improved to ensure maximum productivity, lifetime and unbeatable performance in all materials. The innovative patented **PUSH&LOCK** system makes the traditional hole saw arbor obsolete.

**NEW FEATURES:** 1. One **PUSH&LOCK** arbor for all Hole Saw Series & Diameters. 2. Change your Hole Saw, with a simple **PUSH&LOCK**. 3. Release Plug with a push. 4. Enlarge the existing hole.

## SERIES 550X: MULTI-PURPOSE



**CARBIDE TIPPED**  
**10X LONGER LIFE**  
**FASTER 5X**

### Materials



## SERIES 551X: BI-METAL PLUS



**BIM 8% Co**  
**2X LONGER LIFE**

### Materials



## SERIES 552: DIAMOND DRY



**GRIT**  
**LONG LIFE**

### Materials



## CLAMSHELL PACKAGING

Hole Saws  $\geq 06-5/16"$  are packaged in a carton box.





# HOLE SAWS & CARBIDE WHEEL

## PRODUCTS

## PAGE

<a href="#">XTREME FAST Hole Saw Arbors, Pilot Drills &amp; Kit</a>	310
<a href="#">XTREME FAST Hole Saw Adaptors</a>	311
<a href="#">XTREME FAST Multi-Purpose Hole Saws</a>	312-313
<a href="#">XTREME FAST Bi-Metal Plus Hole Saw</a>	314-315
<a href="#">Diamond Dry Hole Saws for Drill</a>	316
<a href="#">Diamond Dry Hole Saws for Angle Grinder</a>	317
<a href="#">Toolcase for XTREME FAST Hole Saws</a>	318
<a href="#">Multi-Materials Carbide Wheel</a>	318



# CMT XTREME FAST AND PUSH&LOCK SYSTEMS: NEXT GENERATION HOLE SAW



## 1. One PUSH&LOCK arbor for all Hole Saw Series & Diameters

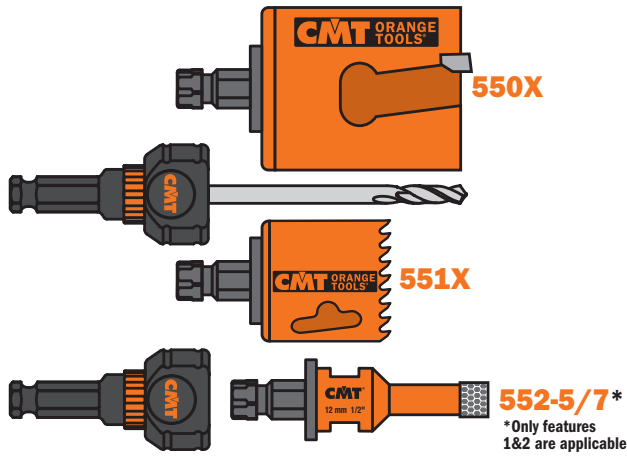

## 2. Change your Hole Saw with a simple PUSH&LOCK

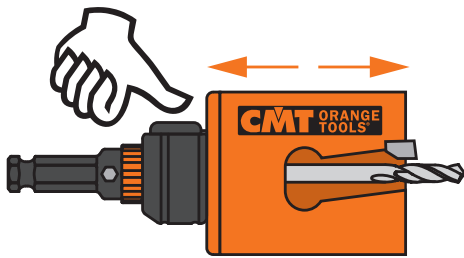

## 3. Release Plug with a push

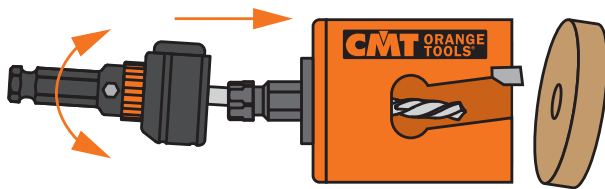

## 4. Enlarge the existing hole (Use adaptor set 550-PA05)

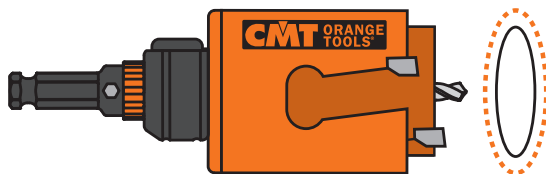



XTREME FAST & FASTX4 COMPATIBILITY (NEW & PREVIOUS SYSTEM)



Do you already have a CMT Hole Saw with the previous FASTX4 System?  
**NO PROBLEM, IT'S STILL GOOD TO GO!**



1. Carefully and firmly secure your FAST4X Hole Saw.  
This will prevent damage to the tool and bodily injury while handling.
2. Unscrew the adaptor attached to your previous FASTX4 Hole Saw.



3. Replace the previous FASTX4 adaptor with the new XTREME FAST adaptor.

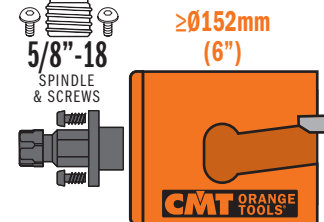
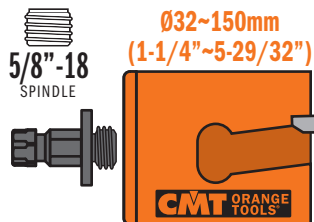
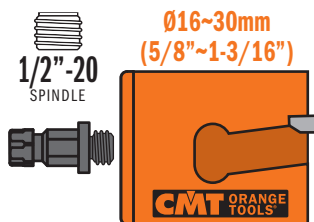

4. Carefully tighten the new adaptor to the Hole Saw with a 13mm spanner. 

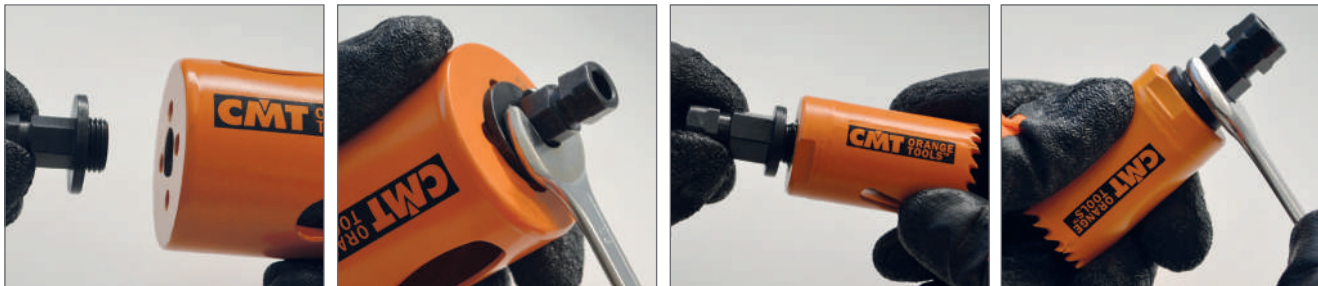

5. Your Hole Saw  
is now compatible with the new  
 **PUSH&LOCK System.**  
**YOU'RE GOOD TO GO!**





One **PUSH&LOCK** arbor for all Hole Saw Series & Diameters  **PUSH & LOCK**

**550-PH85**

**PUSH&LOCK** arbor for **XTREME FAST** system, shank **HEX8.5mm** (11/32"). Compatible with chucks ≤25/64" (10mm). **HSS** pilot drill (**550-PD02** included)

Suitable for Series:

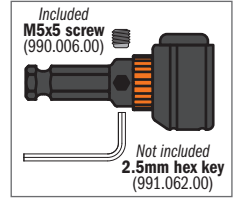

**550-PH11**

**PUSH&LOCK** arbor for **XTREME FAST** system, shank **HEX11mm** (7/16"). Compatible with chucks ≤1/2" (13mm). **HEAVY DUTY**. **HSS** pilot drill (**550-PD02** included)

Suitable for Series:

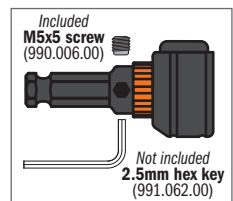

**550-PD01**

**TCT** Pilot drill for **PUSH&LOCK** arbor, Ø17/64" (7mm), L=4-15/16" (125mm).

Suitable for Series:



Materials

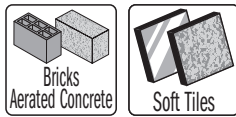

**550-PD02**

**HSS** Pilot drill for **PUSH&LOCK** arbor, Ø1/4" (6.35mm), 4-15/16" (L=125mm).

Suitable for Series:



Materials



**550-PA06 STARTER KIT** (550-PH85 1pc., 550-PA01 2pcs., 550-PA02 3pcs.)



**XTREME FAST** system is compatible with all Hole Saw Series & Diameters **XTREME FAST**

**550-PA01** (3pcs.)

XTREME FAST Adaptor 1/2"-20 for hole saw Ø5/8"~1-3/16" (16~30mm)



Suitable for Series:



Ø5/8"~1-3/16"  
(16~30mm)



**550-PA02** (3pcs.)

XTREME FAST Adaptor 5/8"-18 for hole saw Ø1-1/4"~5-29/32" (32~150mm)



Suitable for Series:



Ø1-1/4"~5-29/32"  
(32~150mm)



**550-PA03** (3pcs.)

XTREME FAST Adaptor 5/8"-18 for hole saw ≥Ø 6" (152mm)



Suitable for Series:



≥Ø6"  
(152mm)

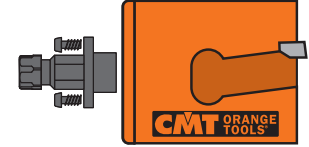

**550-PA07** (3pcs.)

XTREME FAST Adaptor 5/8"-11 for hole saw series 552-7



Suitable for Series:



\*Pilot drill of PUSH&LOCK arbor must be disassembled during use with this series

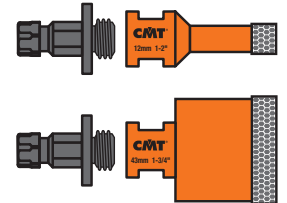

**550-PA05 KIT FOR ENLARGMENT EXISTING HOLE**

(3pcs. LONG SPINDLE)

Example of assembly for existing hole enlargement

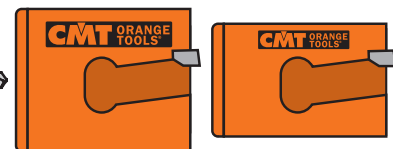
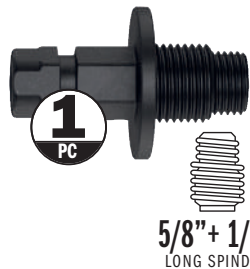
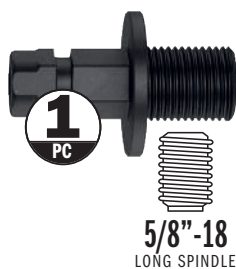
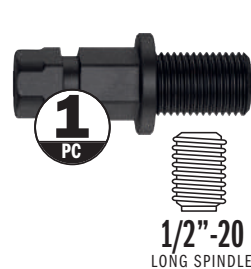

Suitable for Series:



# Multi-Purpose Hole Saws

new

**CMT ORANGE TOOLS®**

**550X**

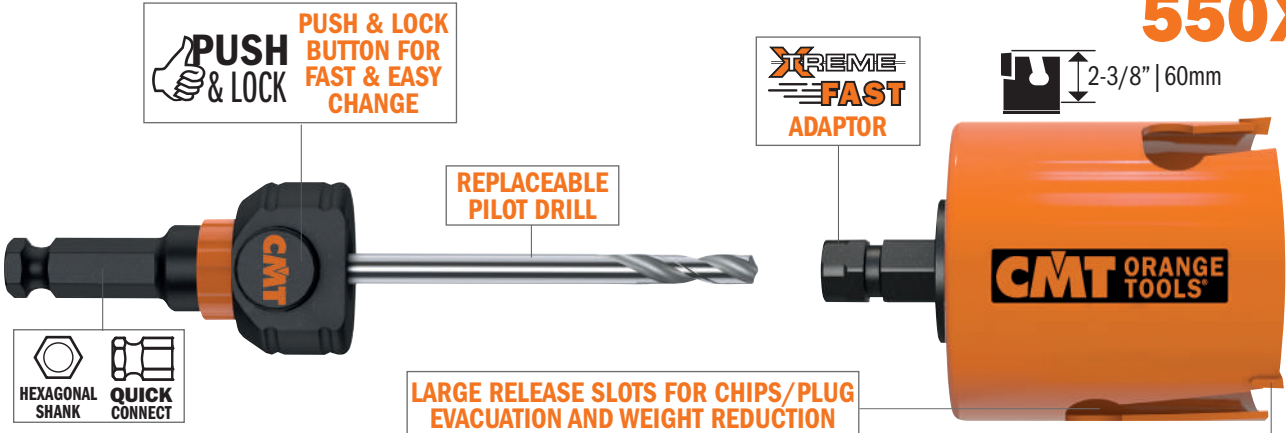

**SECURED TOOTH TECHNOLOGY**  
Thanks to advanced technology, cutting teeth are securely anchored to body, which means they stand up better to hard materials and breakage.

**FASTER 5X** **10X LONGER LIFE**

**CONSTRUCTION CARBIDE**  
Specially formulated construction carbide, used for cutting teeth provide 10X times longer cutting life and performs 5X faster than the standard hole saw.

**CARBIDE TIPPED**

## MATERIALS

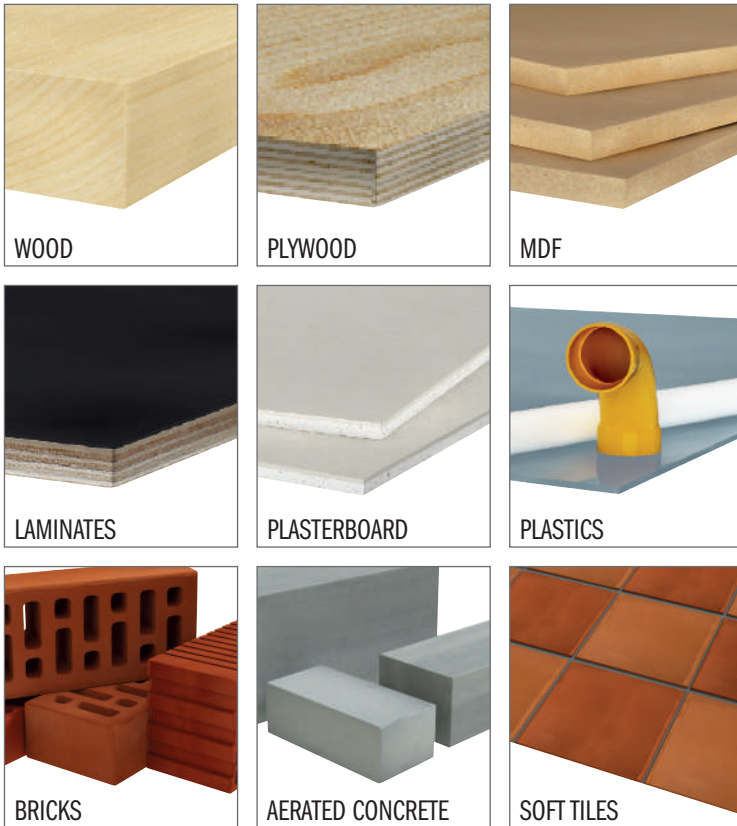

**! SPEED KILLS!**  
Operating at higher speeds than those indicated will shorten hole saw life and produce poor quality holes.

**PRE-BORE:**  
For best results, always pre-bore with the pilot drill only.

**NEVER USE HAMMER MECHANISM WITH THESE HOLESAWS!**

**NEVER USE HAMMER MECHANISM**

**APPLICATIONS:** examples on wood, brick, plastic.





ALL HOLE SAWS 550X ARE EQUIPPED WITH AN XTREME FAST ADAPTOR



ORDER NO.		D		T	WOOD/PLYWOOD RPM*	MDF/LAMINATES RPM*	PLASTERBOARD RPM*	PLASTICS RPM*	BRICK/AERATED CONCRETE RPM*	SOFT TILES RPM*
		inches	mm							
550-019X	10	3/4	19	1	2300	2300	2300	2100	900	700
550-020X	10	25/32	20	1	2200	2200	2200	2000	900	600
550-022X	10	7/8	22	1	2000	2000	2000	1800	800	600
550-025X	10	1	25	1	1800	1800	1800	1600	700	500
550-029X	10	1-1/8	29	1	1500	1500	1500	1400	600	400
550-030X	10	1-3/16	30	1	1500	1500	1500	1300	600	400
550-032X	10	1-1/4	32	1	1400	1400	1400	1200	500	400
550-035X	10	1-3/8	35	1	1300	1300	1300	1100	500	300
550-038X	10	1-1/2	38	2	1100	1100	1100	1000	400	300
550-040X	10	1-9/16	40	2	1100	1100	1100	1000	400	300
550-044X	10	1-3/4	44	2	1000	1000	1000	900	400	300
550-048X	10	1-7/8	48	2	900	900	900	800	300	200
550-051X	10	2	51	3	800	800	800	800	300	200
550-054X	10	2-1/8	54	3	800	800	800	700	300	200
550-056X	10	2-3/16	56	3	800	800	800	700	300	200
550-057X	10	2-1/4	57	3	700	700	700	700	300	200
550-060X	10	2-3/8	60	3	700	700	700	600	300	200
550-064X	10	2-1/2	64	3	700	700	700	600	200	200
550-065X	10	2-9/16	65	3	700	700	700	600	200	200
550-068X	10	2-11/16	68	3	600	600	600	600	200	100
550-070X	10	2-3/4	70	3	600	600	600	500	200	100
550-073X	10	2-7/8	73	3	600	600	600	500	200	100
550-076X	10	3	76	4	500	500	500	500	200	100
550-079X	10	3-1/8	79	4	500	500	500	500	200	100
550-080X	10	3-5/32	80	4	500	500	500	500	200	100
550-082X	10	3-15/64	82	4	500	500	500	500	200	100
550-083X	10	3-1/4	83	4	500	500	500	400	200	100
550-089X	10	3-1/2	89	4	500	500	500	400	200	100
550-092X	10	3-5/8	92	4	400	400	400	400	200	100
550-102X	5	4	102	5	400	400	400	400	100	100
550-105X	5	4-1/8	105	5	400	400	400	300	100	100
550-108X	5	4-1/4	108	5	400	400	400	300	100	100
550-111X	5	4-3/8	111	5	400	400	400	300	100	100
550-114X	5	4-1/2	114	5	300	300	300	300	100	100
550-118X	2	4-5/8	118	6	300	300	300	300	100	100
550-127X	2	5	127	6	300	300	300	300	100	100
550-133X	2	5-1/4	133	6	300	300	300	300	100	100
550-152X	2	6	152	6	200	200	200	200	100	50
550-160X	1	6-5/16	160	7	200	200	200	200	100	50
550-168X	1	6-5/8	168	7	200	200	200	200	100	50
550-185X	1	7-5/16	185	8	200	200	200	200	100	50
550-210X	1	8-1/4	210	8	200	200	200	100	50	50

\*SUGGESTED RPM





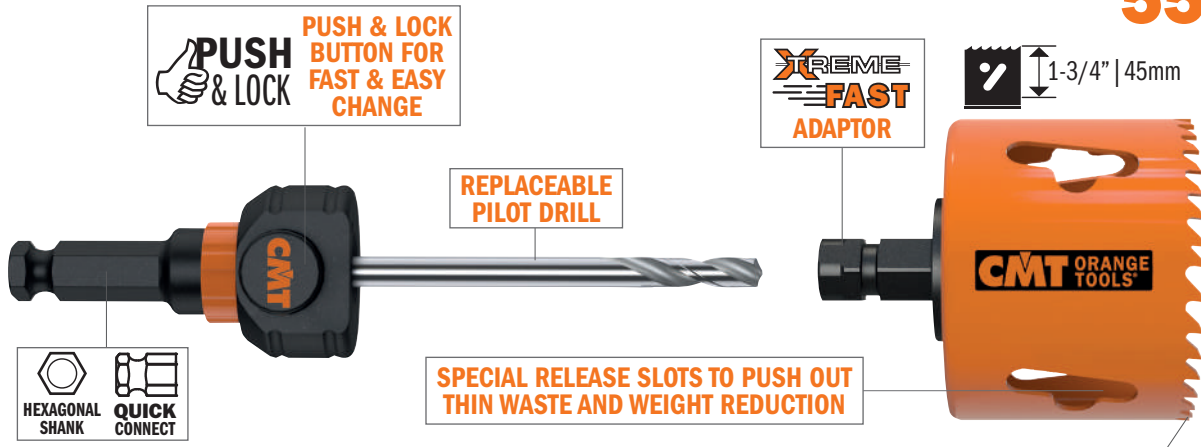

**SPECIAL RELEASE SLOTS TO PUSH OUT THIN WASTE AND WEIGHT REDUCTION**

**TOOTH DESIGN**

Special tooth geometry with variable pitch (4~6 TPI) provides a smoother cut and better chip clearance preventing clogging and heat build-up. Teeth are alternate & side set to minimize binding and friction therefore requiring less feed pressure.

**ALTERNATE & SIDE SET TEETH VARIABLE PITCH (4~6 TPI)**



**BI-METAL 8% COBALT**

Teeth made with Bi-metal 8% Cobalt provide extreme results. Superior performance and 2X longer cutting life than the standard hole saw.

**BIM 8% Co**

**2X LONGER LIFE**

**MATERIALS**



**COOLING LUBRICANT:**

When drilling metals, lubrication serves several purposes:

- it cools the saw and workpiece
- it reduces heat and abrasion which shortens cutting life
- it helps remove swarf from the cutting surface
- it extends hole saw life by 500%.



**SPEED KILLS!**

Operating at higher speeds than those indicated will shorten hole saw life and produce poor quality holes.

**FEED PRESSURE:**

Always consider materials in use and project type. Apply sufficient feed pressure to aid proper chip removal. Reduce the pressure when hole saw becomes hot or if teeth start to clog. Insufficient feed pressure will lead to premature tooth dulling. Too much pressure will damage teeth.

**PRE-BORE:**

For best results, always pre-bore with the pilot drill only.

**NEVER USE HAMMER MECHANISM WITH THESE HOLESAWS!**



**APPLICATIONS:** examples on steel, sandwich material.



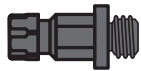

ALL HOLE SAWS 551X ARE EQUIPPED WITH AN XTREME FAST ADAPTOR



ORDER NO.		D		STAINLESS STEEL	CAST IRON	STEEL	ALUMINUM	COPPER/BRASS	PLASTICS
		inches	mm	RPM*	RPM*	RPM*	RPM*	RPM*	RPM*
551-016X	10	5/8	16	160	240	320	500	500	500
551-019X	10	3/4	19	140	200	280	420	420	420
551-020X	10	25/32	20	120	200	260	400	400	400
551-022X	10	7/8	22	120	180	240	360	360	360
551-025X	10	1	25	100	160	200	320	320	320
551-027X	10	1-1/16	27	80	140	180	300	300	300
551-029X	10	1-1/8	29	80	140	180	280	280	280
551-030X	10	1-3/16	30	80	120	160	260	260	260
551-032X	10	1-1/4	32	80	120	160	240	240	240
551-035X	10	1-3/8	35	60	100	140	220	220	220
551-038X	10	1-1/2	38	60	100	140	200	200	200
551-040X	10	1-9/16	40	60	100	120	200	200	200
551-043X	10	1-11/16	43	60	80	120	180	180	180
551-044X	10	1-3/4	44	60	80	120	180	180	180
551-048X	10	1-7/8	48	40	80	100	160	160	160
551-051X	10	2	51	40	80	100	160	160	160
551-054X	10	2-1/8	54	40	60	80	140	140	140
551-057X	10	2-1/4	57	40	60	80	140	140	140
551-060X	10	2-3/8	60	40	60	80	120	120	120
551-064X	10	2-1/2	64	40	60	80	120	120	120
551-065X	10	2-9/16	65	40	60	80	120	120	120
551-068X	10	2-11/16	68	20	60	60	120	120	120
551-070X	10	2-3/4	70	20	40	60	100	100	100
551-073X	10	2-7/8	73	20	40	60	100	100	100
551-076X	10	3	76	20	40	60	100	100	100
551-079X	10	3-1/8	79	20	40	60	100	100	100
551-083X	10	3-1/4	83	20	40	60	80	80	80
551-086X	10	3-3/8	86	20	40	60	80	80	80
551-089X	10	3-1/2	89	20	40	60	80	80	80
551-092X	10	3-5/8	92	20	40	40	80	80	80
551-102X	5	4	102	20	40	40	80	80	80
551-105X	5	4-1/8	105	20	20	40	60	60	60
551-108X	5	4-1/4	108	20	20	40	60	60	60
551-114X	5	4-1/2	114	20	20	40	60	60	60
551-127X	2	5	127	20	20	40	60	60	60
551-133X	2	5-1/4	133	20	20	40	60	60	60
551-140X	2	5-1/2	140	10	20	20	40	40	40
551-152X	2	6	152	10	20	20	40	40	40
551-168X	1	6-5/8	168	10	20	20	40	40	40

\*SUGGESTED RPM

# Diamond Dry Hole Saws



Diamond dry hole saws with continuous edge have been specially developed for professionals that need to drill in extremely tough materials like **HARD TILES (ceramic, gres, etc.)**, **HARD STONES (granite, marble, etc.)**, **ARTIFICIAL STONES (OKITE®, SILESTONE®, etc.)**, in which it is increasingly difficult to drill with conventional hole saws. Drilling other masonry materials is also possible, but it will reduce tool life. These hole saws guarantee excellent performance and superior lifetime!

# 552

## MATERIALS



**DIAMOND GRIT**  
Diamond grit featuring strong cubo-octahedral inclusion-free heat-resistant crystals, guarantees fast clean cutting and longer cutting life than the standard hole saw.



AVAILABLE WITH SHANK



**HEXAGONAL SHANK**



**M14 SPINDLE**



## 552-0 For Drill

ORDER NO.		D	I	L	HARD TILES (CERAMIC & GRES) HARD STONES, ARTIFICIAL STONES	S
		inches	mm	inches		
552-005	10	3/16	5	1-3/16	2-11/16	RPM 2200 ~ 4000 * HEX
552-006	10	1/4	6	1-3/16	2-11/16	RPM 2200 ~ 4000 * HEX
552-008	10	5/16	8	1-9/16	3-1/8	RPM 2200 ~ 4000 * HEX
552-010	10	3/8	10	1-9/16	3-1/8	RPM 2200 ~ 4000 * HEX
552-012	10	1/2	12	1-9/16	3-1/8	RPM 2200 ~ 4000 * HEX
552-014	10	9/16	14	1-9/16	3-1/8	RPM 2200 ~ 4000 * HEX
552-016	10	5/8	16	1-9/16	3-1/8	RPM 2200 ~ 4000 * HEX

\*We recommend the use of a high speed drill (minimum 14V)

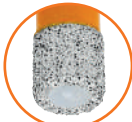

Filled with cooling wax **552-WAX**



## 552-WAX COOLING & LUBRICATING WAX

While drilling, the wax will melt away (eliminated along with drilling waste). This facilitates cooling and lubrication. Replenish wax after every use (when still warm) to extend lifetime.

PACK QTY. 10 pcs.



## 552-001-05

5 PIECE HOLE SAW SET

- 552-005 Ø3/16" (5mm)
- 552-006 Ø1/4" (6mm)
- 552-008 Ø5/16" (8mm)
- 552-010 Ø3/8" (10mm)
- 552-012 Ø1/2" (12mm)

PACK QTY. 10 pcs.

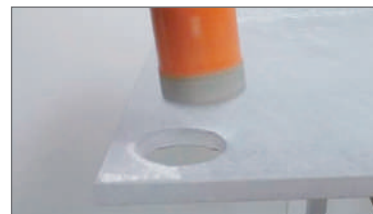
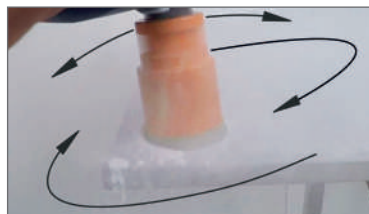
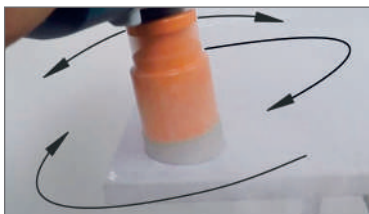
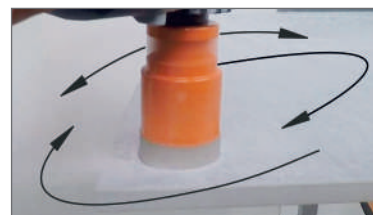
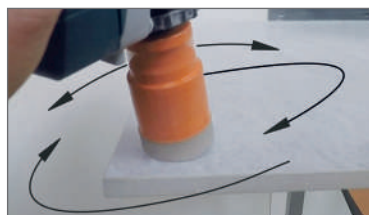
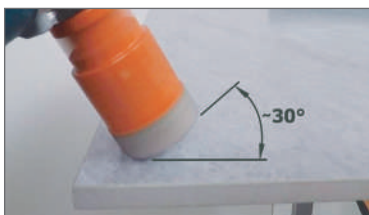





**5/8"-11**  
SPINDLE

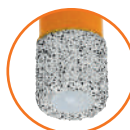

Filled with cooling wax **552-WAX** (until Ø16mm)



≥ Ø3/4" without cooling wax

## 552-7 For Angle Grinder

ORDER NO.		inches	D mm	I inches	L inches	HARD TILES (CERAMIC & GRES) HARD STONES, ARTIFICIAL STONES	S
552-705	10	3/16	5	1-3/8	2-3/8	MAX RPM 14000	5/8"-11
552-706	10	1/4	6	1-3/8	2-3/8	MAX RPM 14000	5/8"-11
552-708	10	5/16	8	1-3/8	2-3/8	MAX RPM 14000	5/8"-11
552-710	10	3/8	10	1-3/8	2-3/8	MAX RPM 14000	5/8"-11
552-712	10	1/2	12	1-3/8	2-3/8	MAX RPM 14000	5/8"-11
552-716	10	5/8	16	1-3/8	2-3/8	MAX RPM 14000	5/8"-11
552-719	10	3/4	20	1-9/16	2-3/8	MAX RPM 14000	5/8"-11
552-725	10	1	25	1-9/16	2-3/8	MAX RPM 14000	5/8"-11
552-732	10	1-1/4	32	1-9/16	2-3/8	MAX RPM 14000	5/8"-11
552-735	10	1-3/8	35	1-9/16	2-3/8	MAX RPM 14000	5/8"-11
552-738	10	1-1/2	38	1-9/16	2-3/8	MAX RPM 14000	5/8"-11
552-751	10	2	51	1-9/16	2-3/8	MAX RPM 14000	5/8"-11
552-754	10	2-1/8	54	1-9/16	2-3/8	MAX RPM 14000	5/8"-11
552-789	5	3-1/2	89	5/8	2-3/8	MAX RPM 14000	5/8"-11

## 552-GUIDE

Drill Guide with Suction Cups - 7 holes  
Ø5/32" - 3/16" - 1/4" - 9/32" - 5/16" - 3/8" - 1/2"  
Ø4 - 5 - 6 - 7 - 8 - 10 - 12mm

PACK QTY. 10 pcs.



## 552-701-06 6 PIECE HOLE SAW SET

- 552-706 Ø1/4" (6mm)
- 552-708 Ø5/16" (8mm)
- 552-710 Ø3/8" (10mm)
- 552-712 Ø1/2" (12mm)
- 552-GUIDE
- 552-EX16

PACK QTY. 10 pcs.



**550-PA07**  
XTREME FAST Adaptor 5/8"  
(series 552-7) for  
PUSH&LOCK System (see page 311)

**552-EX16**  
Hexagonal adaptor 5/8"  
(series 552-7) for drills

PACK QTY. 10 pcs.

### 552 RECOMMENDATIONS FOR USE:

Turn on drill to start tool rotation. Begin drilling at a 30° angle - this is the angle measured between the hole saw and the working surface. Cutting at an angle will prevent tool from slipping and facilitate precision centering. To improve stability during operation, use the working surface as leverage by resting the drill against it.

Continue the cut vertically, accompanying the tool in an orbital motion. This will favor better cooling and chip evacuation. (If you are using a guide, begin the cut vertically, then lift the guide and continue cutting in an orbital motion).

Remember, the hole saw is not a drill bit. Attempting to bore holes perpendicular to the work surface on a frequent basis will drastically reduce tool lifespan.

Using water as a cooling agent may help extend the life of the hole saw.

**RPM SUGGESTED?** High RPM values reduce the possibility of damaging/burning the diamond edge, ensuring a longer life.

**NEVER USE HAMMER MECHANISM WITH THESE HOLESAWS!**

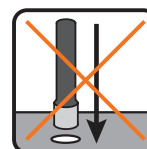



## Toolcase for XTREME FAST Hole Saws

new

**CMT ORANGE TOOLS®**



**XTREME FAST**

**PUSH & LOCK**



UP TO  
**11**  
HOLE SAWS

UP TO  
**24**  
HOLE SAWS

UP TO  
**63**  
HOLE SAWS

The toolcase is provided empty, image is purely indicative.

A toolcase can contain 1 Push&Lock arbor, 1 Pilot Drill and relative number of XTreme Fast Hole Saws.  
The number of Hole Saws to be contained is dependent on diameter.

ORDER NO.	DESCRIPTION
03.01.0531	Toolcase <b>SMALL</b> - Up to <b>11</b> Hole Saws
03.01.0532	Toolcase <b>MEDIUM</b> - Up to <b>24</b> Hole Saws
03.01.0533	Toolcase <b>LARGE</b> - Up to <b>63</b> Hole Saws

## Multi-Materials Carbide Wheel

new

**286 ITK<sup>+</sup>PLUS®**



**MULTI-MATERIALS**

### SAFETY TIPS

ALWAYS: Use both hands;  
Use wheel guard;  
Clamp workpiece.

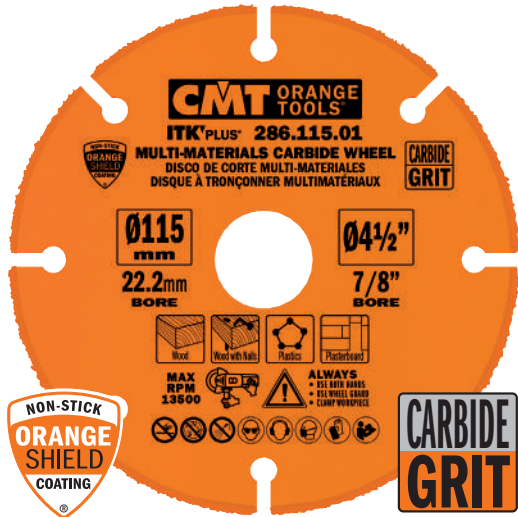

ORDER NO.		D inches	B inches
286.115.01	10	4-1/2	7/8 (+3/8+5/8)
286.125.01	10	5	7/8 (+20mm+5/8)
286.230.01	5	9	7/8

### MACHINES



ANGLE GRINDER



MINI CORDLESS CIRC. SAW

### MATERIALS



WOOD



WOOD/WOOD & NAILS



PLASTIC



PLASTERBOARD

Blade diameter compatibility is contingent on machine type.

For specific details regarding suggested materials, please check blade label.



# CUTTER HEADS, INSERT KNIVES & SPARE PARTS

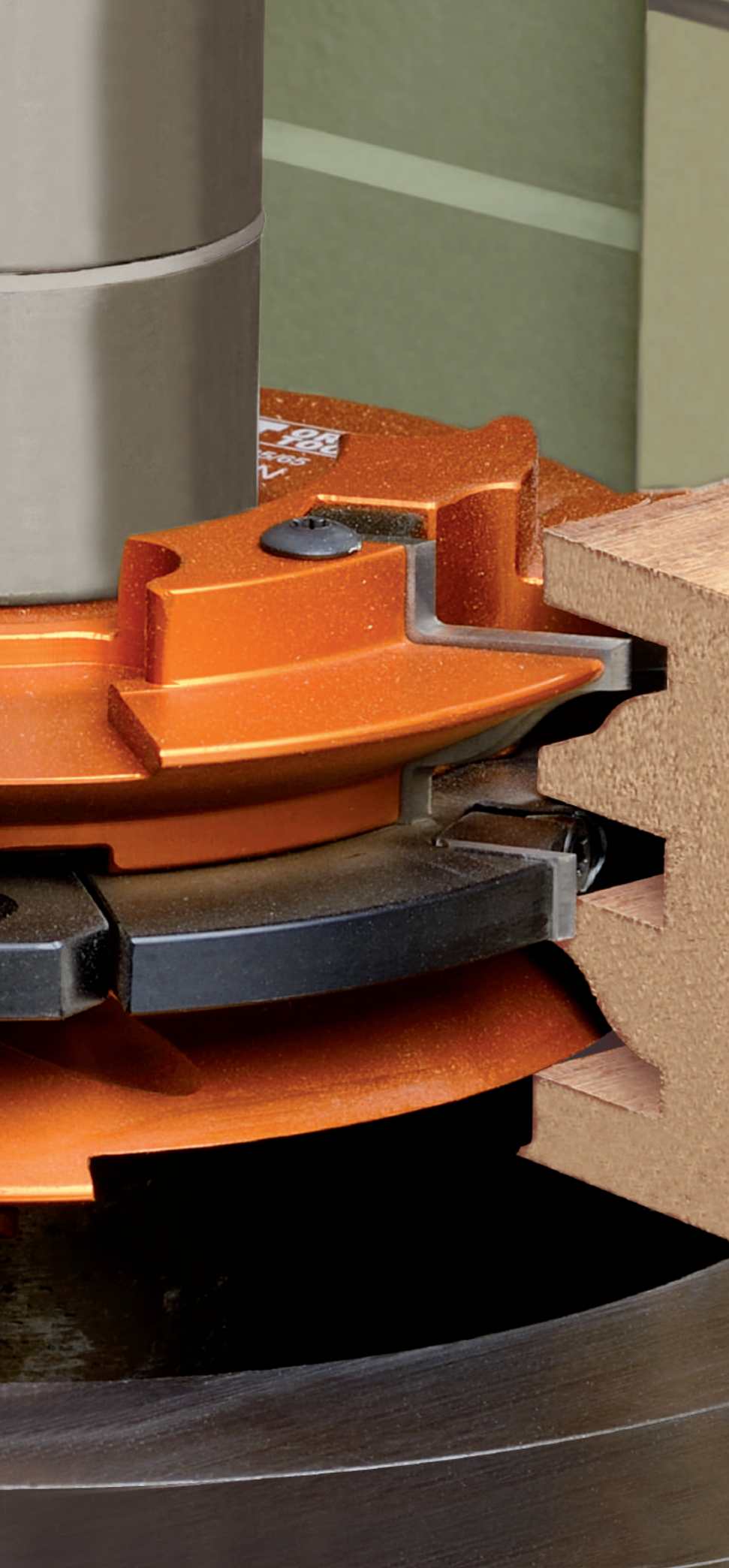

<b>PRODUCTS</b>	<b>PAGE</b>
Rabbeting Cutter Head	320
Adjustable Grooving Set	321-322
Adjustable Rounding & Chamfering Sets	323
45° Chamfer Cutter Head	324
Roundover Cutter Head	325-326
Roundover & Cove Cutter Head	327
Jointing Cutter Heads	328~330
Raised Panel Cutter Heads	331
Rail & Stile Cutter Heads	332~334
Universal Shaper Cutter Heads and Bore Reducers	335
Cabinet & Joinery Set, Molding & Profile Set	336
Profile Knives for the Insert Shaper System 40mm	337~346
Profile Knives for the Insert Shaper System 50mm	346~349
Planer & Jointer Knives and Setting Jigs	350
Solid Carbide Insert Knives for Portable Planers	351
Solid Carbide Insert Knives	352-353
Spare Parts & Accessoires	354~356





# Rabbeting Cutter Heads



Supplied in a sturdy plastic carry case

## 694.100



These cutter heads have been designed for:

- rabbeting from either top or bottom;
- jointing
- grooving

For use on spindle moulder machines, double-end tenoner and edging machines.

Suitable for all materials, but best on chipboard, MDF, wood composites, plastic materials and laminates. Improved design with shear angle.

### TECHNICAL DETAILS:

- Hard aluminum alloy body with high resistance to tensile and yield stress.
- 2 universal Solid Carbide straight knives 50x12x1.5mm [T2], 1 up cut - 1 down cut.
- 4 universal Solid Carbide scoring knives 14x14x2mm [V4].
- Tools for manual feed (MAN).
- Pins for automatic positioning of the knives.

### SAFETY TIPS:



The **TW-006** Torque Screwdriver is recommended for the proper fastening of screws (see page 267).

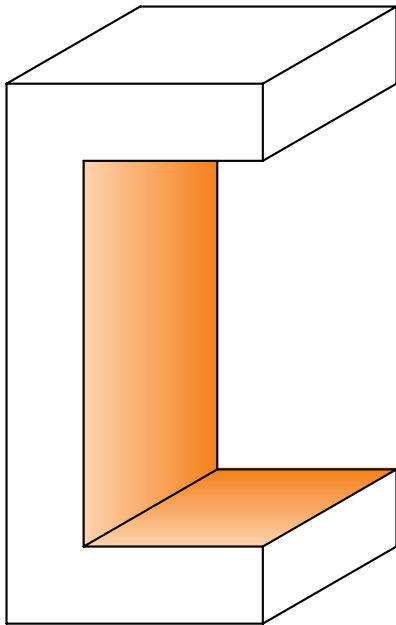

Drawing is 1:1 scale

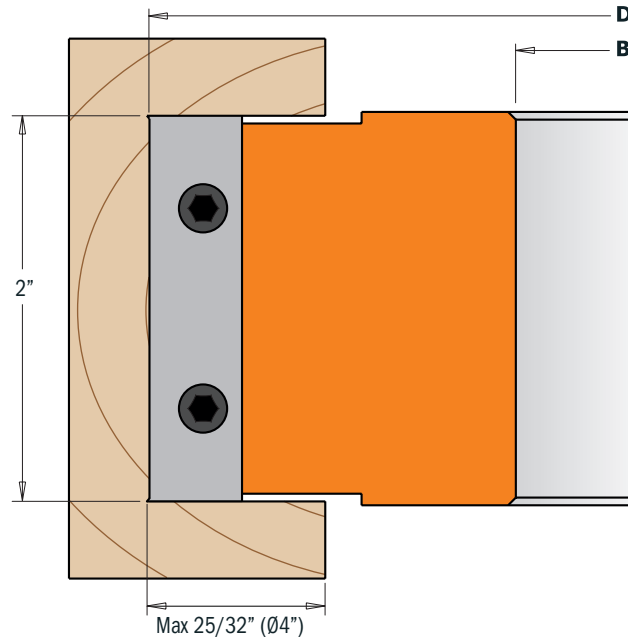

ORDER NO.	Box	D		B		RPM
		inches	mm	inches	mm	
694.100.19	1	4	100	3/4	19.05	7500~12500
694.100.31	1	4	100	1-1/4	31.75	7500~12500

### Spare parts

790.140.00*	990.093.00	991.073.00	790.500.00*	695.999.46	990.064.00	991.064.00
790.140.00*	990.093.00	991.073.00	790.500.00*	695.999.46	990.064.00	991.064.00

\*Minimum 10 pieces or multiple

# 3-piece Adjustable Grooving Sets



## 694.001



These cutter heads are the ideal tools to create precision slots and grooves 5/32" to 19/32" in depth. These sets include:

- 2 cutter heads type **(A)** [T4 + V4]
- 1 cutter head type **(B)** [T2]
- 12 spacer rings from 0.1 to 2mm

For use on spindle moulder machines, moulder, double-end tenoner and edging machines. Perfect grooving on all materials, but ideal on hardwood, plywood and laminated panels.

### TECHNICAL DETAILS:

- Super-strength steel body.
- 2 Solid Carbide Knives 7.65x12x1.5mm [T2].
- 4 Solid Carbide Knives 18x18x1.95mm [T4].
- 4 Solid Carbide Knives 14x14x1.2mm [V4].
- Tools for manual feed (MAN).
- Pins for automatic positioning of the knives.

### SAFETY TIPS:



The **TW-006** Torque Screwdriver is recommended for the proper fastening of screws (see page 267).



Supplied in a sturdy plastic carry case

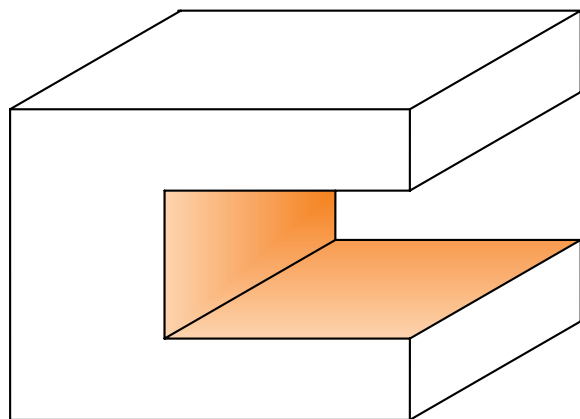
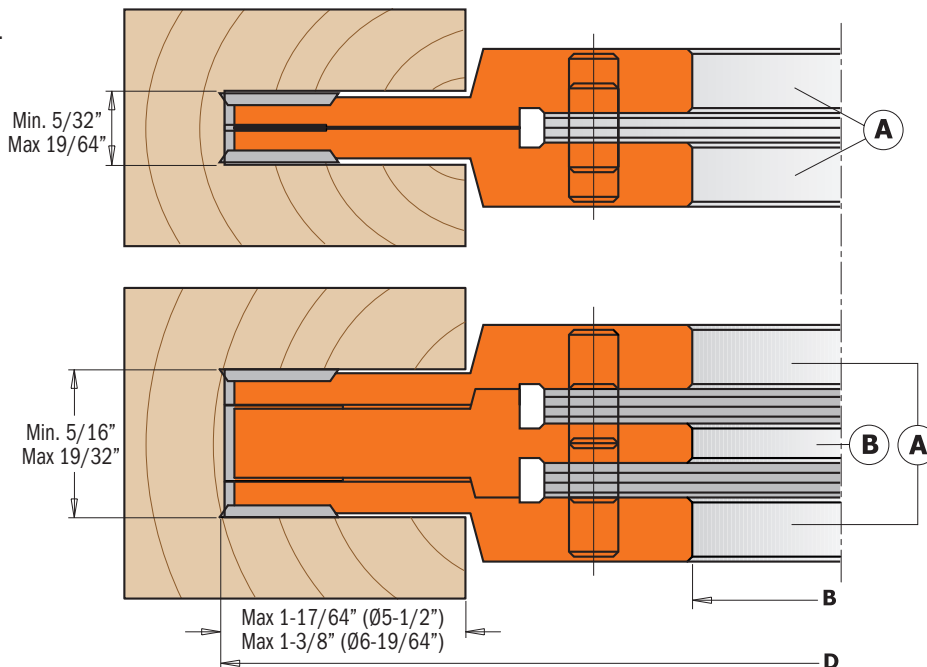

Drawing is 1:1 scale

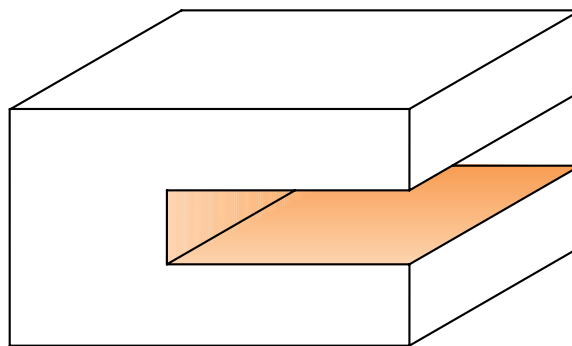

ORDER NO.		D		B		RPM
		inches	mm	inches	mm	
694.001.31	1	5-1/2	140	1-1/4	31.75	5500~9500

### Spare parts

790.181.00*	790.140.10*	790.076.00*	695.998.22

### Spare parts: For cutter heads (A)

- 990.079.00** M4x3.2mm TORX® screws
- 991.069.00** T9 TORX® key
- 695.996.02** M4 (Ø12x1.7mm) threaded ring
- 695.996.01** M4 (Ø10x1.6mm) threaded ring

### Spare parts: For cutter heads (B)

- 695.999.07** 7x11x9.5mm wedge for knives
- 990.063.00** M5x18mm screw
- 991.072.00** T20 TORX® key

\*Minimum 10 pieces or multiple



# 2-piece Adjustable Grooving Sets



## 694.021 - 694.022



These cutter heads are the perfect tools to create precision slots and grooves 9/16" to 1-35/64" in depth. This set includes:

- 1 cutter head type (A) [T2+V2]
- 1 cutter head type (B) [T2+V2]
- set of spacer rings.

For use on spindle moulder machines, moulders, double-end tenoners and edging machines. Perfect grooving on all materials, but ideal on hard wood, plywood and laminated panels.

### TECHNICAL DETAILS:

- Super-strength hard aluminum alloy body.
- **694.021:** 8 Solid Carbide knives  
13.6x13.6x2mm.
- **694.022:** 4 Solid Carbide knives  
19.5x12x1.5mm.  
4 Solid Carbide knives 14x14x2mm.
- Tools for manual feed (MAN).
- Pins for the automatic positioning of the knives.

### SAFETY TIPS:



The **TW-006** Torque Screwdriver is recommended for the proper fastening of screws (see page 267).



Supplied in a sturdy plastic carry case

### 299 Spacer Rings (Optional)

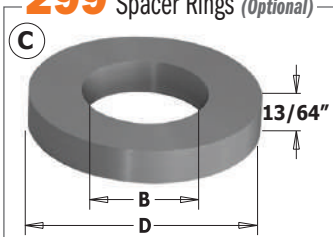

ORDER NO.	B inches	D inches
299.560.31	1-1/4	2-3/8

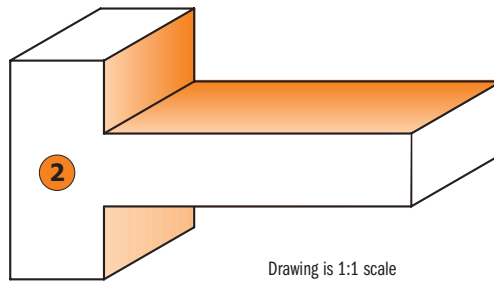
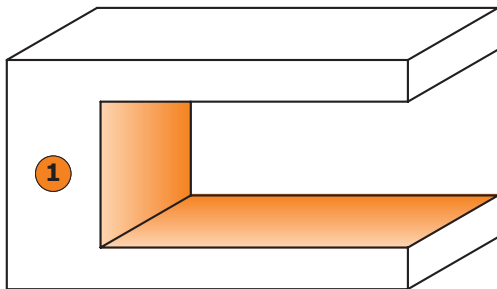
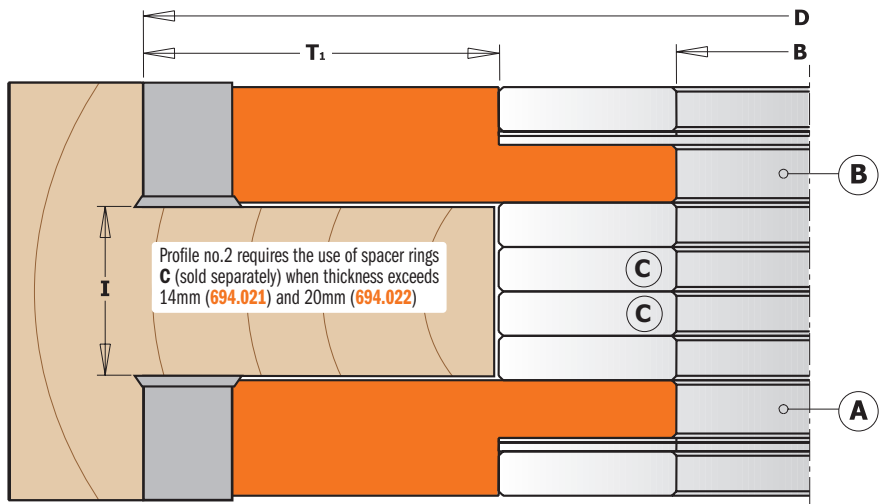
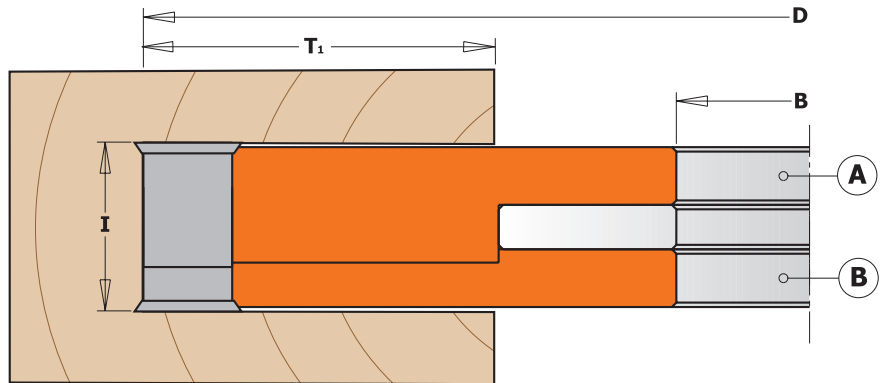

Drawing is 1:1 scale

ORDER NO.	Box Icon	D		B		I mm	T1 mm	RPM
		inches	mm	inches	mm			
694.021.31	1	5-29/32	150	1-1/4	31.75	14-27	44	5000~8000
694.022.31	1	6-45/64	170	1-1/4	31.75	20-39	54	4400~7400

### Spare parts

Icon 1	Icon 2	Icon 3	Icon 4	Icon 5
790.136.00*	990.093.00			695.998.42
790.140.00*	990.093.00	790.195.12*	990.094.00	695.998.47

Spare parts: **991.072.00** T20 TORX® key  
**991.073.00** T25 TORX® key

\*Minimum 10 pieces or multiple

# 2-piece Adjustable Rounding & Chamfering Sets



## 694.005



The CMT adjustable rounding and chamfering set consists of two pieces for easy to set up on your spindle moulder machine. Includes five different knives for rounding over top and bottom edges in one single pass with a radius of 5/64", 1/8", 5/32", 3/16" and 15/64" and for 45° chamfering on material 18mm to 50mm in thickness. The improved design with shear angle guarantees perfect finishing! For use on spindle moulder machines.

### TECHNICAL DETAILS:

- Hard aluminum alloy body with high resistance to tensile and yield stress.
- One pair of Solid Carbide top knives (A) radius 5/32" and 45° chamfer (20x20.5x2mm) [T2].
- One pair of Solid Carbide bottom knives (B) radius 5/32" and 45° chamfer (20x20.5x2mm) [T2].
- Two Solid Carbide knives 50x12x1.5mm.
- Set of 21 spacer rings from 0.1 to 3mm
- Tools for manual feed (MAN)
- Pins for the automatic positioning of the knives.

### SAFETY TIPS:



The **TW-006** Torque Screwdriver is recommended for the proper fastening of screws (see page 267).

Supplied in a sturdy plastic carry case

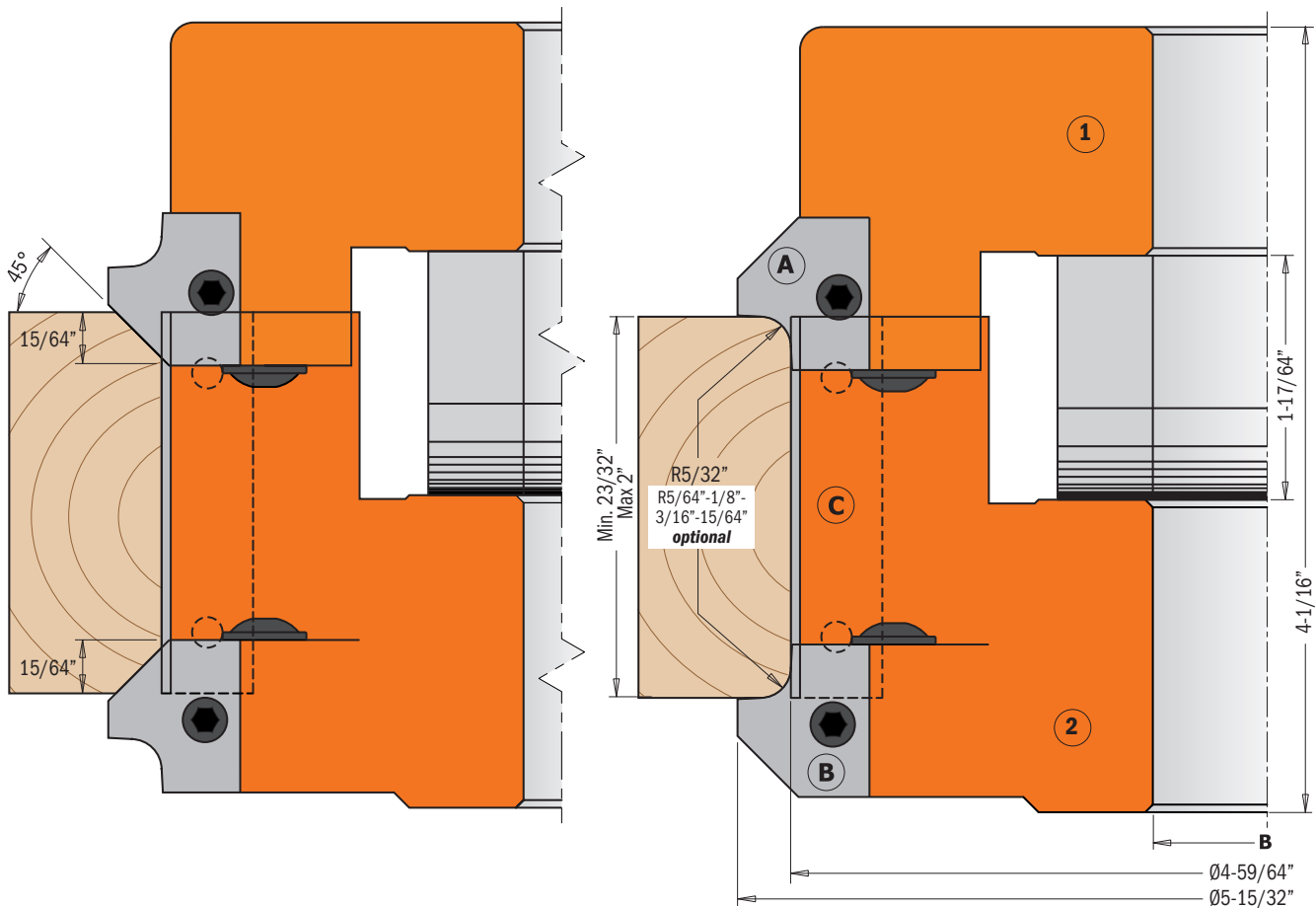

ORDER NO.		D		B		RPM
		inches	mm	inches	mm	
694.005.31	1	5-15/32	139	1-1/4	31.75	5500~9400

**Spare parts:** 695.005.A4 Pair of knives for roundover/chamfer (top) R=4+45°  
 695.005.B4 Pair of knives for roundover/chamfer (bottom) R=4+45°  
 790.500.00 Knives 50x12x1.5mm  
 991.064.00 Hex key 4mm  
 991.067.00 Hex key 3mm

### Spare parts

	17x11x9.5mm		46x11x9.5mm		990.064.00		695.998.12
	695.999.17		695.999.46				

**Optional:** 695.005.A2 Pair of knives for roundover/chamfer (top) R=2+45°  
 695.005.A3 Pair of knives for roundover/chamfer (top) R=3+45°  
 695.005.A5 Pair of knives for roundover/chamfer (top) R=5+45°  
 695.005.A6 Pair of knives for roundover/chamfer (top) R=6+45°  
 695.005.B2 Pair of knives for roundover/chamfer (bottom) R=2+45°  
 695.005.B3 Pair of knives for roundover/chamfer (bottom) R=3+45°  
 695.005.B5 Pair of knives for roundover/chamfer (bottom) R=5+45°  
 695.005.B6 Pair of knives for roundover/chamfer (bottom) R=6+45°

# 45° Chamfer Cutter Heads



**694.002**



CMT chamfer cutter heads carry out clean accurate bevels and joints for excellent edge work. For use on spindle moulder machines, moulder, double-end tenoners, edge banding machines. Suitable for all materials, but ideal on hardwood, plywood and laminated panels.

**TECHNICAL DETAILS:**

- Hard aluminum alloy body with high resistance to tensile and yield stress.
- 2 Solid Carbide Knives 50x12x15mm [T2].
- Tools for manual feed (MAN).
- Pins for the automatic positioning of the knives



Supplied in a sturdy plastic carry case

**SAFETY TIPS:**



The **TW-006** Torque Screwdriver is recommended for the proper fastening of screws (see page 267).

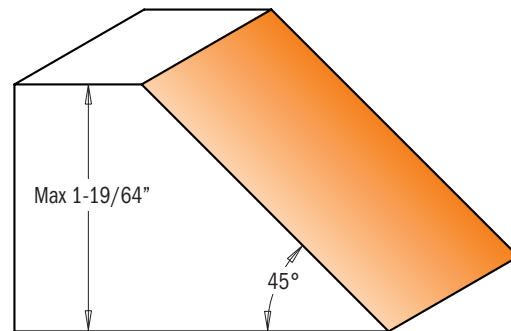
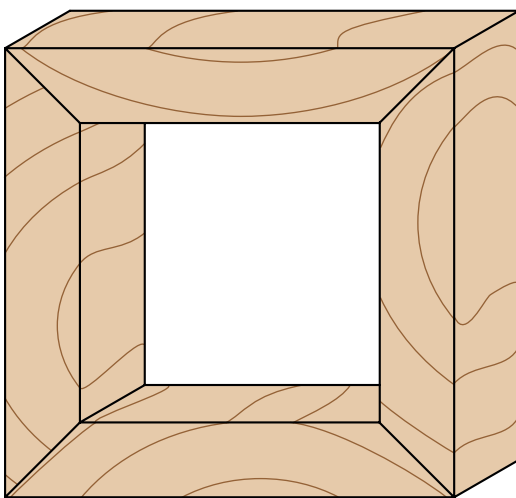
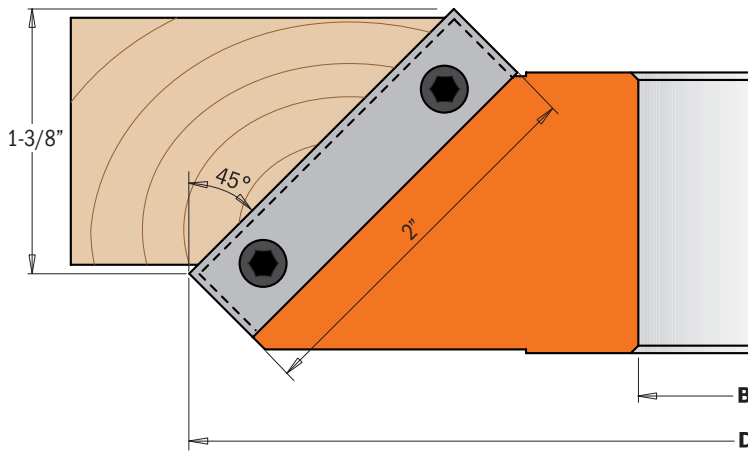

Drawing is 1:1 scale

ORDER NO.		D		B		RPM
		inches	mm	inches	mm	
694.002.31	1	5-29/32	150	1-1/4	31.75	5100~8800

**Spare parts**

			
790.500.00*	695.999.42	990.064.00	991.064.00

790.500.00 are supplied in 10-piece pack or multiple



Supplied in a sturdy plastic carry case

## 694.004

Innovative cutter heads supporting two different knives for making four radius roundover profiles. Standard cutter heads are sold with knives featuring 15 and 20mm radii; an additional knife set is available for 12-18mm radii.

**For use on spindle moulder machines, moulder and shaping machines.**  
Suitable for all materials, but ideal on hard wood and wood panels.

### TECHNICAL DETAILS:

- Hard aluminum alloy body with high resistance to tensile and yield stress.
- 2 Solid Carbide knives radius 15/20mm (45x34.5x2mm) [T2].
- Tools for manual feed (MAN).
- Pins for the automatic positioning of the knives.

### SAFETY TIPS:



The **TW-006** Torque Screwdriver is recommended for the proper fastening of screws (see page 267).

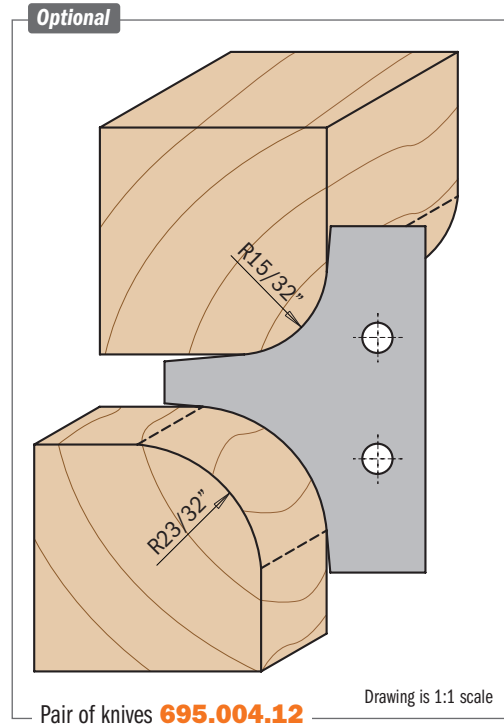
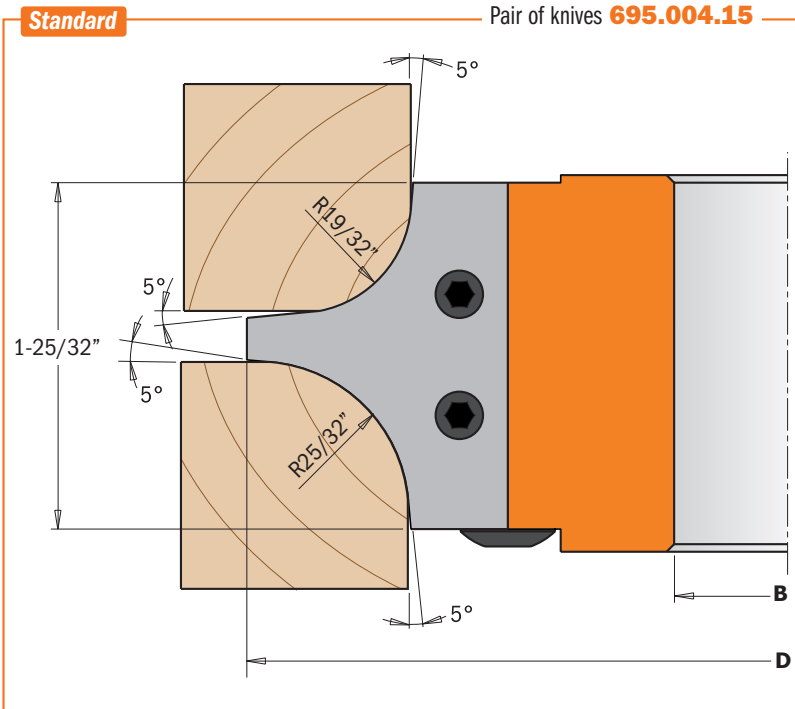

ORDER NO.	1	D		B		RPM
		inches	mm	inches	mm	
<b>694.004.31</b>		5-13/64	132	1-1/4	31.75	5700~9500

### Spare parts

x2 695.004.15	 695.999.42	 990.064.00	 991.064.00
------------------	----------------	----------------	----------------

Optional: **695.004.12** R=15/32" and 23/32" (45x34.5x2mm) pair of profiled knives



# Multiradius Roundover Cutter Heads



## 694.003



Innovative cutter heads featuring three different knives for making six radius roundover profiles. Standard cutter heads are sold with knives featuring 5 and 10mm radii; two more knife sets are available for making 4-8mm and 3-6mm radii. For use on spindle moulder machines, moulder machines and shaping machines. Suitable for all materials, but ideal on hard wood and panels.

### TECHNICAL DETAILS:

- Hard aluminum alloy body with high resistance to tensile and yield stress.
- 2 Solid Carbide knives radius 5/10mm (25x24.8x2mm) [T2].
- Tools for manual feed (MAN).
- Pins for the automatic positioning of the knives.



Supplied in a sturdy plastic carry case

### SAFETY TIPS:



The **TW-006** Torque Screwdriver is recommended for the proper fastening of screws (see page 267).

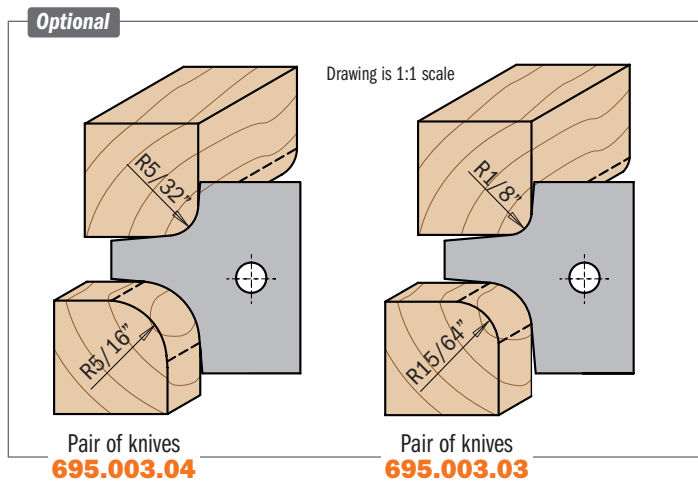
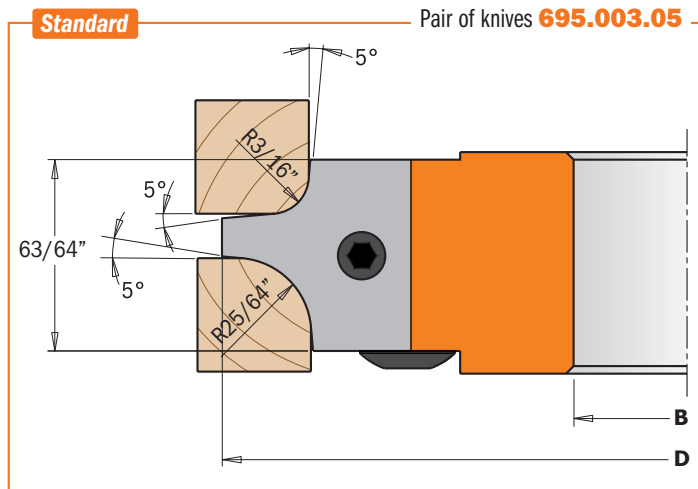

ORDER NO.		D		B		RPM
		inches	mm	inches	mm	
<b>694.003.31</b>	<b>1</b>	4-29/64	113	1-1/4	31.75	6700~11000

### Spare parts

x2			
695.003.05	695.999.22	990.064.00	991.064.00

**Optional:** **695.003.04** Pair of profiled knives R=5/32" and 5/16" (25x24.8x2mm)  
**695.003.03** Pair of profiled knives R=1/8" and 15/64" (25x24.8x2mm)



## 694.007



These cutter heads are perfect for making furniture, doors and drawer fronts simply and stylishly by applying a final touch with a CMT cove bit. It is also used for making perfect roundover profiles, drop leaf counters and table tops. You can use three different knives for carrying out roundover and cove profiles with radii 25/64", 15/32" and 19/32". For use on spindle moulder machines, moulder and shaping machines. Suitable for all materials, but ideal on solid wood and panel materials.

### TECHNICAL DETAILS:

- Hard aluminum alloy body with high resistance to tensile and yield stress.
- 2 Solid Carbide knives radius 25/64" (34.8x29.3x2mm) [T2].
- Tools for manual feed (MAN).
- Pins for the automatic positioning of the knives.



Supplied in a sturdy plastic carry case

### SAFETY TIPS:



The **TW-006** Torque Screwdriver is recommended for the proper fastening of screws (see page 267).

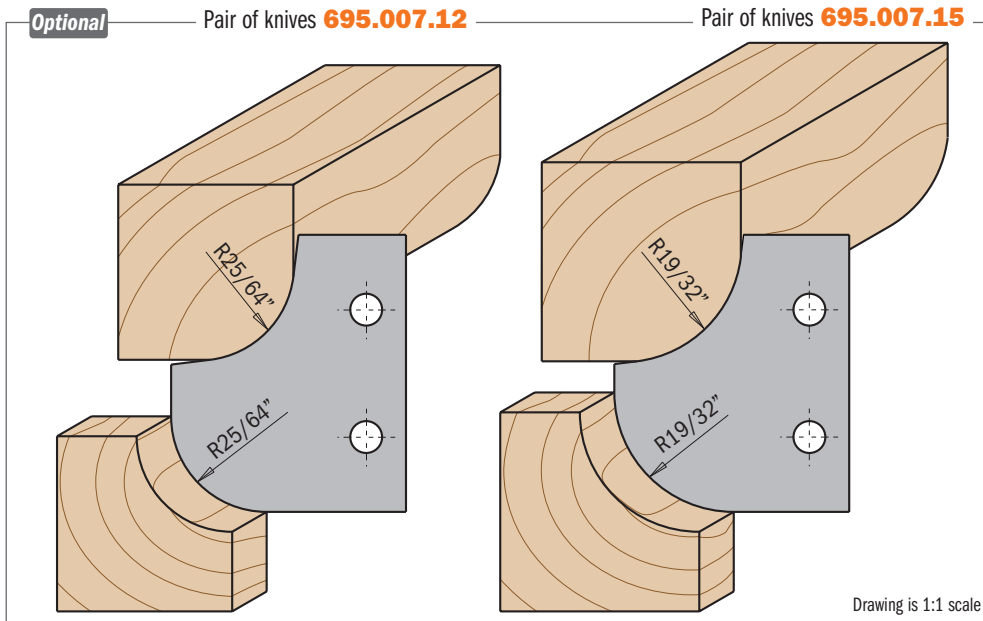
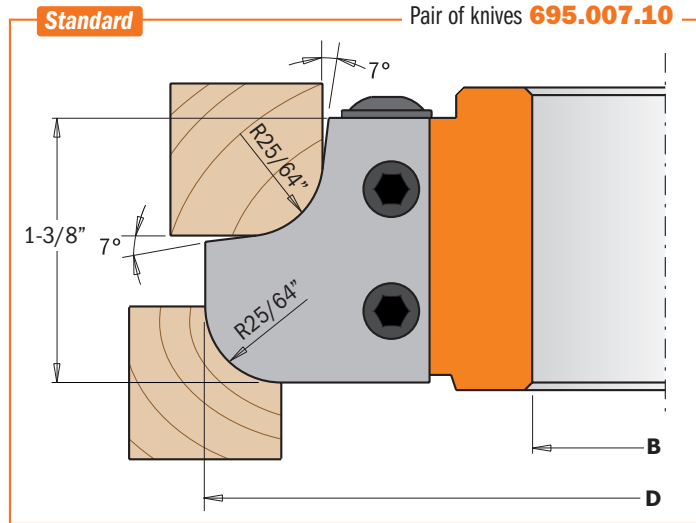

ORDER NO.		D		B		RPM
		inches	mm	inches	mm	
694.007.31	1	4-3/4	121	1-1/4	31.75	6300~10500

### Spare parts

x2 695.007.10	 695.999.31	 990.064.00	 991.064.00
------------------	----------------	----------------	----------------

Optional: **695.007.12** Pair of roundover/cove knives R=25/64" (34.8x29.3x2mm)  
**695.007.15** Pair of roundover/cove knives R=19/32" (34.8x29.3x2mm)

# Reverse Glue Joint Cutter Heads



**694.009**



One of the unique characteristics of this CMT cutter head is its capacity to craft indestructible glue joints both quickly and accurately. Ideal for shaping panels, doors and furniture pieces of wide proportion.

Simply run one side of the panel, turn the panel over, and then run the opposite side. The result? Perfectly harmonized reverse cuts which match up to produce a flawless joint. Excellent for most materials, but ideal on hard wood, and wood panels.

For spindle moulder machines and double-end tenoners.

**TECHNICAL DETAILS:**

- Hard aluminum alloy body with high resistance to tensile and yield stress.
- 2 Solid Carbide knives 40x18x2mm [T2].
- Tools for manual feed (MAN).
- Pins for the automatic positioning of the knives.



Supplied in a sturdy plastic carry case

**SAFETY TIPS:**



The **TW-006** Torque Screwdriver is recommended for the proper fastening of screws (see page 267).

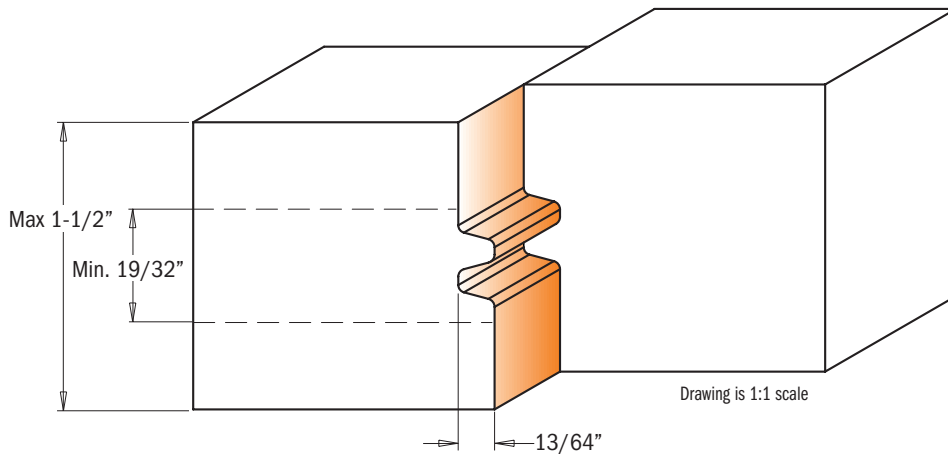
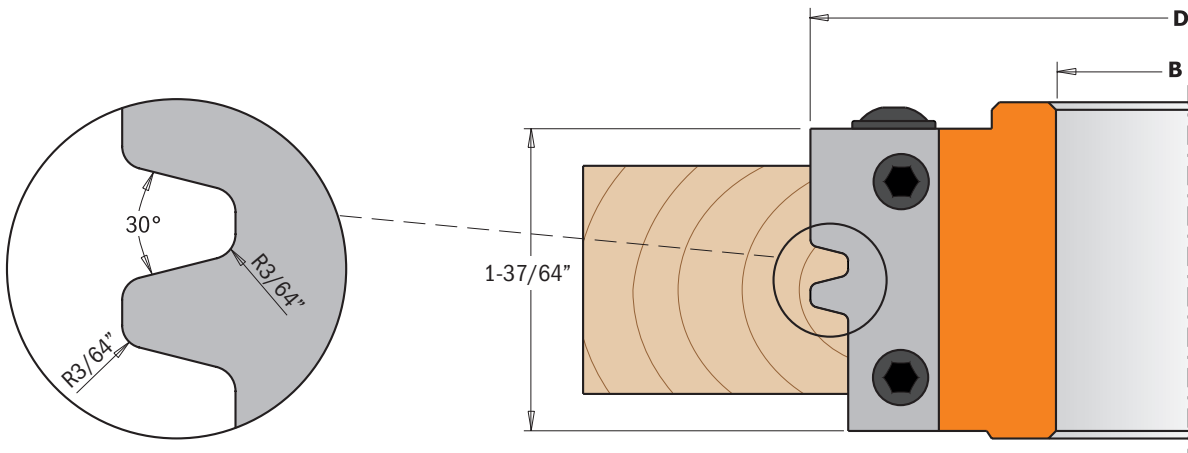

ORDER NO.		D		B		RPM
		inches	mm	inches	mm	
694.009.31	1	4	100	1-1/4	31.75	7500~12500

**Spare parts**

x2			
695.009.01	695.999.38	990.064.00	991.064.00

# 45° Lock Miter Cutter Heads



## 694.011



CMT's lock miter cutter heads are ideal for milling miter joints in stock a maximum of 28mm in thickness. Create boxes, stretcher bars, frames and any assortment of right angle (90°) or parallel joint projects. Two easy steps to produce perfect fitting 45° miter joints: first, position and mill your workpiece horizontally, then vertically.

Create parallel glue joints in two steps: position and mill your workpiece horizontally, internal side facing down, and then turn it facing up. For use on spindle moulder machines and shaper machines. Perfect on all materials, but ideal on solid wood and panels.

### TECHNICAL DETAILS:

- Hard aluminum alloy body with high resistance to tensile and yield stress.
- 2 Solid Carbide knives 43x23x2mm [T2].
- Tools for manual feed (MAN).
- Pins for the automatic positioning of the knives.

### SAFETY TIPS:



The **TW-006** Torque Screwdriver is recommended for the proper fastening of screws (see page 267).



Supplied in a sturdy plastic carry case

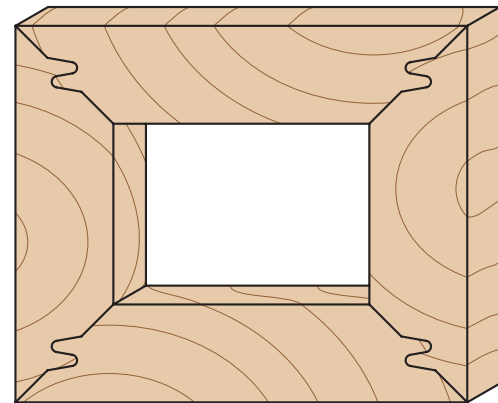
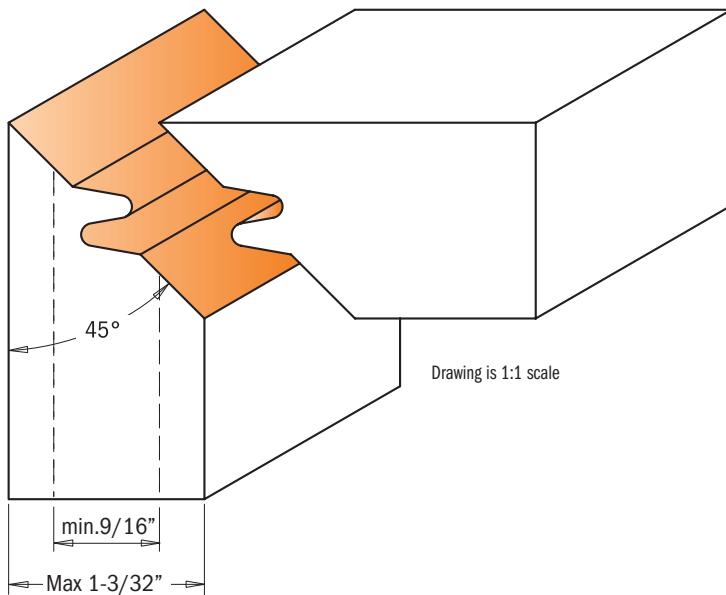
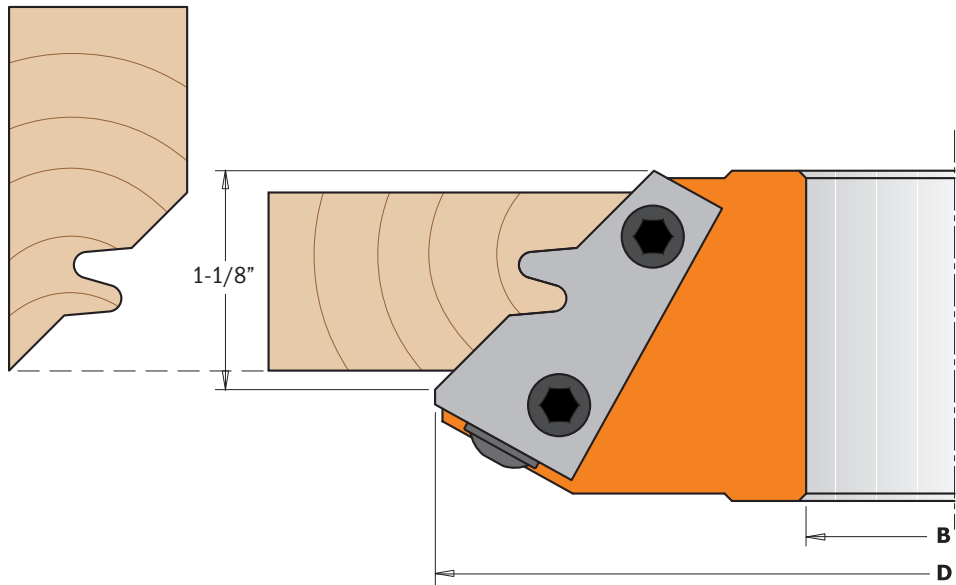

ORDER NO.		D		B		RPM
		inches	mm	inches	mm	
694.011.31	1	5-1/2	140	1-1/4	31.75	5500~9500

### Spare parts

 x2			
695.011.01	695.999.42	990.064.00	991.064.00



# Professional Finger Joint Cutter Heads

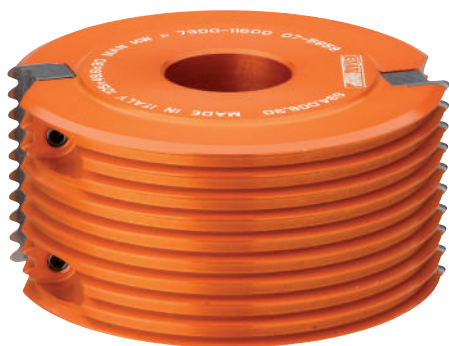

## 694.008



The CMT professional finger joint cutter head makes the strongest side-to-side joints on all wood types and composites. The tightness of the joint and the maximum surface area for glue application ensure that the joint itself is stronger than an unworked piece of wood. Maximum thickness 47mm.

**For use on spindle moulder machines.** Perfect for moulding and furniture specialists. Suitable for all materials, but ideal on hard wood and wood panels.

### TECHNICAL DETAILS:

- Hard aluminum alloy body with high resistance to tensile and yield stress.
- 2 Solid Carbide knives 49.6x11.9x1.5mm [T2].
- Tools for manual feed (MAN).
- Pins for the automatic positioning of the knives.





Supplied in a sturdy plastic carry case

### SAFETY TIPS:

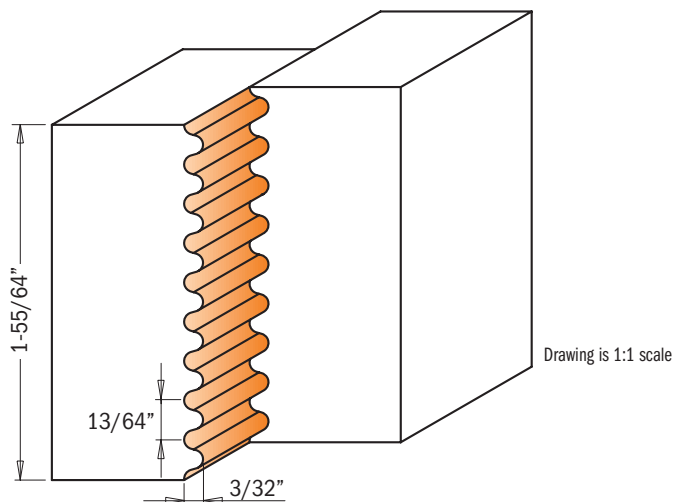
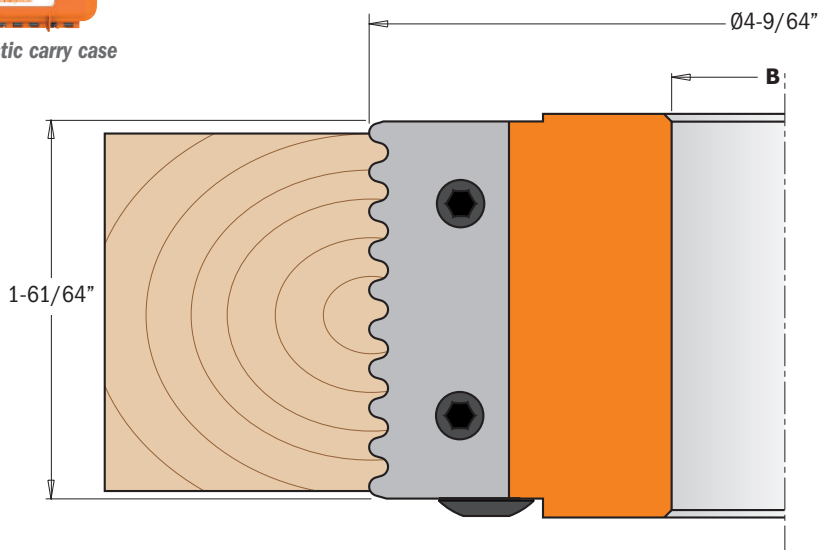

The **TW-006** Torque Screwdriver is recommended for the proper fastening of screws (see page 267).



ORDER NO.		D		B		RPM
		inches	mm	inches	mm	
694.008.31	1	4-9/64	105	1-1/4	31.75	7300~11500

### Spare parts

 x2 695.008.01	 695.999.49	 990.066.00	 991.067.00
--	---	---	---

Optional: 695.998.2631 Guide ring with bore 1-1/4"

# Professional Raised Panel Cutter Heads



## 694.013



We offer a traditional approach to panel construction with these CMT raised panel cutter heads. Engineered using the most sophisticated technology, it represents a key element in the artisans' workshop. Create classic raised panels on furniture, interior and cabinet doors on solid wood and wooden boards, and achieve three different profiles by adjusting the cutting depth. We recommend multiple passes for safe and accurate finishing. For use on spindle moulders, moulders, and double-end tenoners. Perfect for all materials, but ideal on hard wood and panels.



Supplied in a sturdy plastic carry case

### TECHNICAL DETAILS:

- Hard aluminum alloy body with high resistance to tensile and yield stress.
- 2 Solid Carbide Knives type (A) 19.8x11.9x1.5mm [T2].
- 2 Solid Carbide Knives type (B) 60x11.9x1.5mm [T2].
- Tools for manual feed (MAN).
- Pins for the automatic positioning of the knives.

### SAFETY TIPS:



The **TW-006** Torque Screwdriver is recommended for the proper fastening of screws (see page 267).

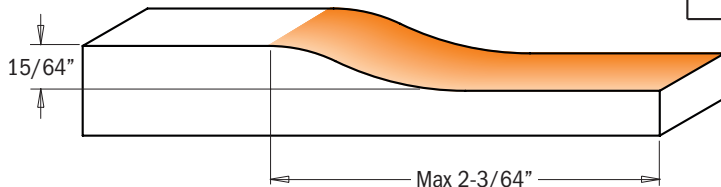
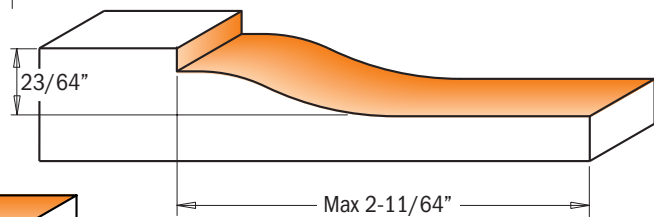
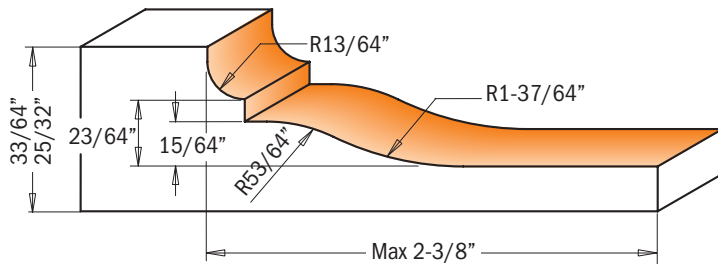
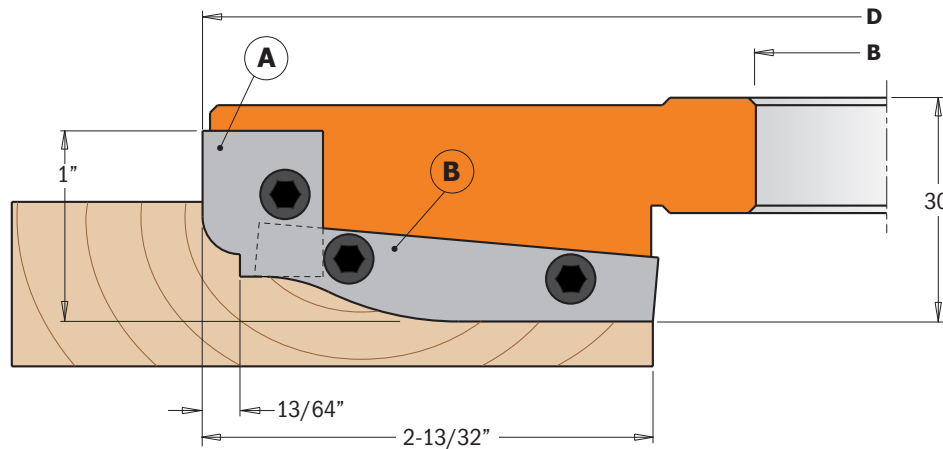

Drawing is 1:1 scale

ORDER NO.		D		B		RPM
		inches	mm	inches	mm	
694.013.31	1	7-13/64	183	1-1/4	31.75	4100~7000

Spare parts: 991.083.00 Hex key 3x90x135mm

### Spare parts

x2	16x11x9,5mm	x2	53x11x9,5mm	
695.013.A1	695.999.16	695.013.A2	695.999.53	990.066.00

# Profile & Counter Profile Cutter Head Sets



## 694.015



These versatile sets were designed to make furniture and doors on soft and hardwood. It allows the insertion of five different knives to produce the most popular and classical profiles. The adjustable cutter, included in the set, can also be used individually to carry out grooves between 8mm 15mm. For use on spindle moulders and moulder machines. Perfect on hard wood and panels maximum 22 - 25mm in thickness.

### TECHNICAL DETAILS:

- Hard aluminum alloy body with high resistance to tensile and yield stress for cutter heads (1 & 2).
- Super-strength steel body for cutter head (3).
- 2 Solid Carbide knives type (A1) 25x29.8x2mm [T2].
- 2 Solid Carbide knives type (A2) 25x29.8x2mm [T2].
- 4 Solid Carbide knives 7.65x12x1.5mm [T4].
- 4 Solid Carbide knives 14x14x2mm for heads type (1 & 2).
- 12 spacer rings from 0.1 to 3mm for heads type (1 & 2).
- 12 spacer rings from 0.1 to 2mm for heads type (3).
- Tools for manual feed (MAN).
- Pins for the automatic positioning of the knives.



Supplied in a sturdy plastic carry case

### SAFETY TIPS:



The **TW-006** Torque Screwdriver is recommended for the proper fastening of screws (see page 267).

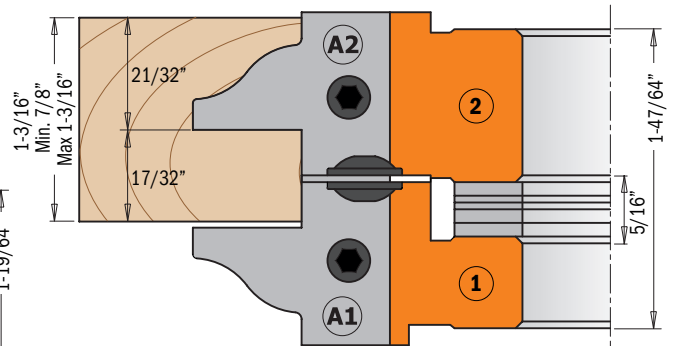
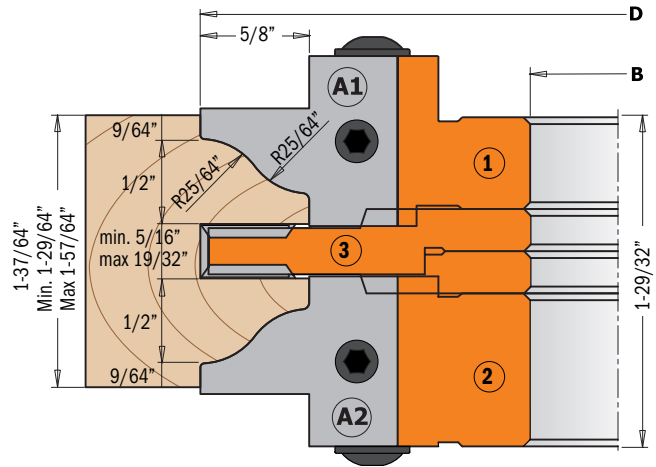
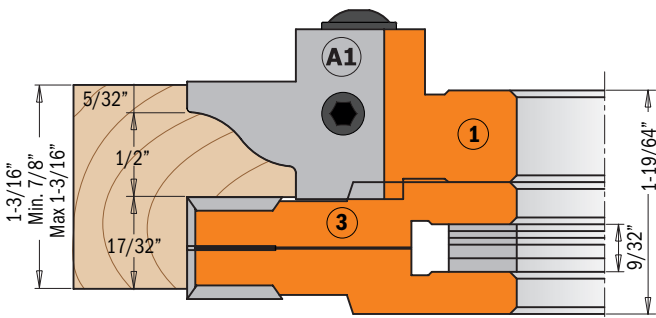
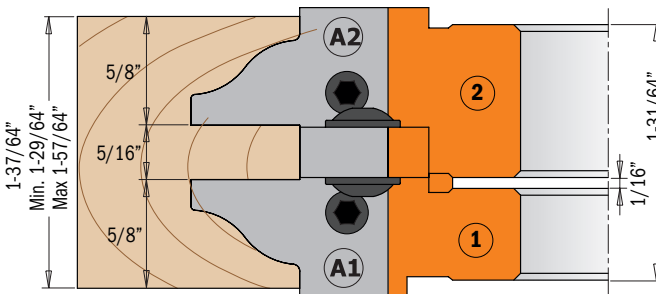

ORDER NO.		D		B		RPM
		inches	mm	inches	mm	
<b>694.015.31</b>	<b>1</b>	5-13/64	132	1-1/4	31.75	5700-9500

### Spare parts

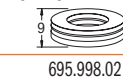

### Optional

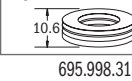

### Spare parts:

#### Head type (1)

- 695.015.A1** Pair of knives solid carbide (A1) 25x29.8x2mm
- 695.015.B1** Pair of knives solid carbide (B1) 25x29.8x2mm
- 695.015.C1** Pair of knives solid carbide (C1) 25x29.8x2mm
- 695.015.D1** Pair of knives solid carbide (D1) 25x29.8x2mm
- 695.015.E1** Pair of knives solid carbide (E1) 25x29.8x2mm
- 695.999.23** Wedge for knives 23x11x9.5mm
- 990.066.00** Screw M6x16mm
- 991.067.00** Hex key 3mm

#### Head type (2)

- 695.015.A2** Pair of knives solid carbide (A2) 25x29.8x2mm
- 695.015.B2** Pair of knives solid carbide (B2) 25x29.8x2mm
- 695.015.C2** Pair of knives solid carbide (C2) 25x29.8x2mm
- 695.015.D2** Pair of knives solid carbide (D2) 25x29.8x2mm
- 695.015.E2** Pair of knives solid carbide (E2) 25x29.8x2mm
- 695.999.24** Wedge for knives 23x11x9.5mm
- 990.066.00** Screw M6x16mm
- 991.067.00** Hex key 3mm

#### Head type (3)

- 790.076.00\*** Solid carbide knives 7.65x12x1.5mm
- 695.999.07** Wedge for knives 6.8x11x9.5mm
- 990.063.00** Screw M5x18mm
- 991.072.00** Hex key T20 Hex key
- 790.140.00\*** Solid carbide Knives 14x14x2mm
- 990.080.00** Screw M5x6,5mm
- 991.073.00** Hex key T25

\*Minimum 10 pieces or multiple

**Standard**

Pair of knives **695.015.A1** - Pair of knives **695.015.A2**

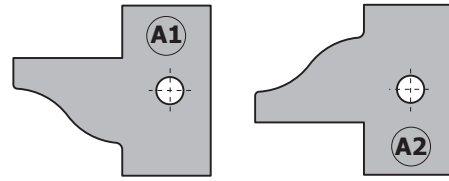
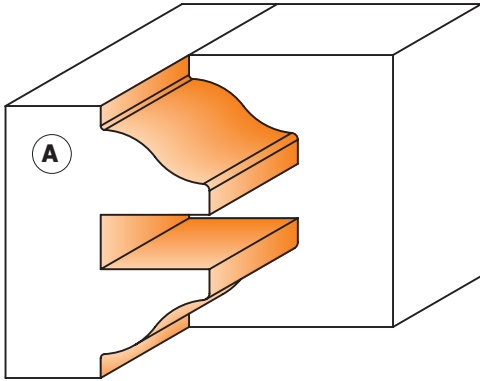

**Optional**

Pair of knives **695.015.B1**  
Pair of knives **695.015.B2**

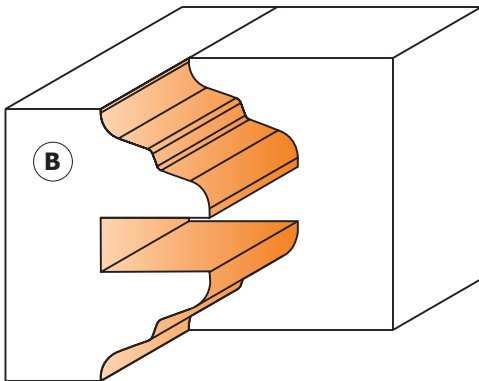
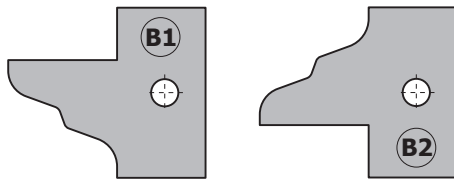

Pair of knives **695.015.C1**  
Pair of knives **695.015.C2**

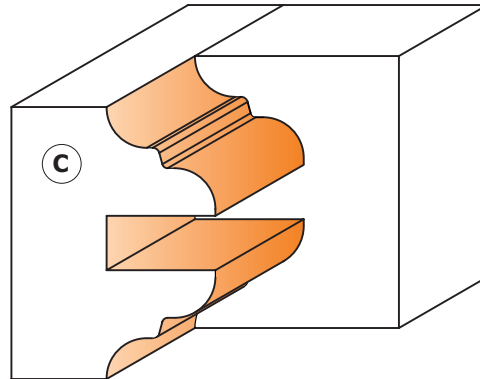
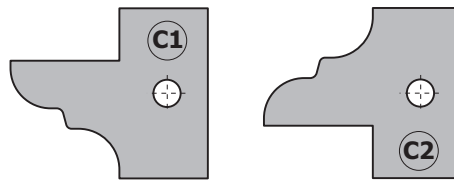

Pair of knives **695.015.D1**  
Pair of knives **695.015.D2**

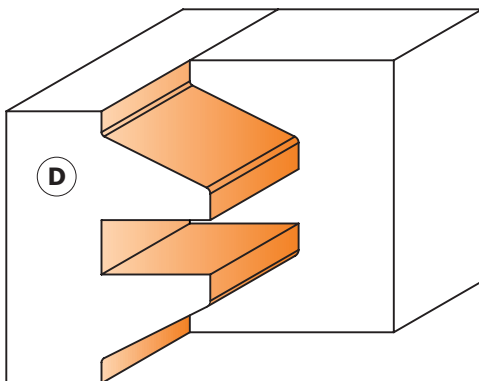
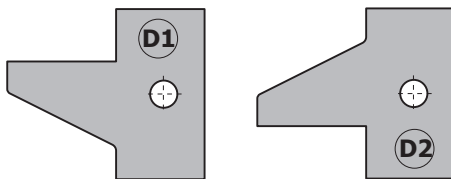

Pair of knives **695.015.E1**  
Pair of knives **695.015.E2**

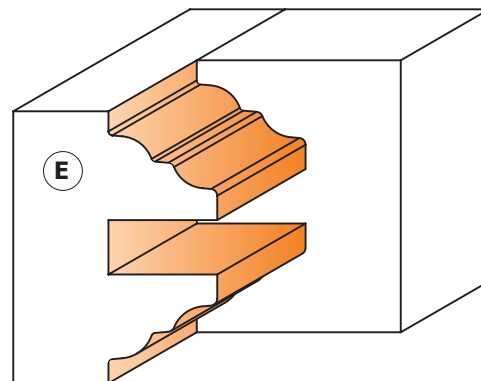
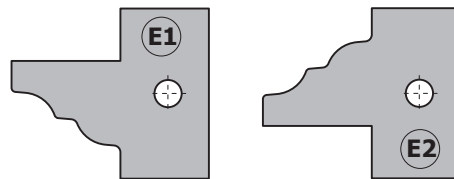



# 1-piece Rail & Stile Cutter Heads

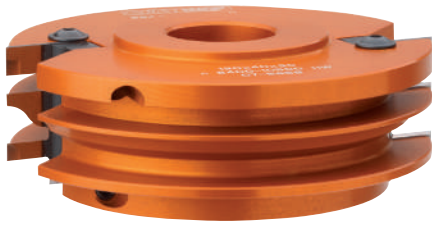

## 694.014



These are unique products made by combining two cutter heads, ideal for making furniture doors and drawers. By adjusting the height of the of the cutter head, you can cut two perfectly fitted profiles without wasting time or effort on the fence or replacing the tool. Improve your efficiency and save money only having to purchase one single cutter head!!! For use on spindle moulders. Perfect on hardwood and panels between 22mm-25mm in thickness.



Supplied in a sturdy plastic carry case

### TECHNICAL DETAILS:

- Hard aluminum alloy body with high resistance to tensile and yield stress.
- 2 Solid Carbide knives type (A) 40x24.5x2mm [T2].
- Tools for manual feed (MAN).
- Pins for the automatic positioning of the knives.

### SAFETY TIPS:



The **TW-006** Torque Screwdriver is recommended for the proper fastening of screws (see page 267).

### Standard

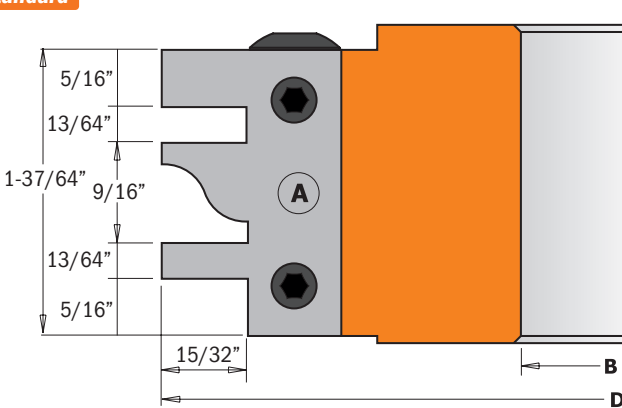

### Pair of knives 695.014A

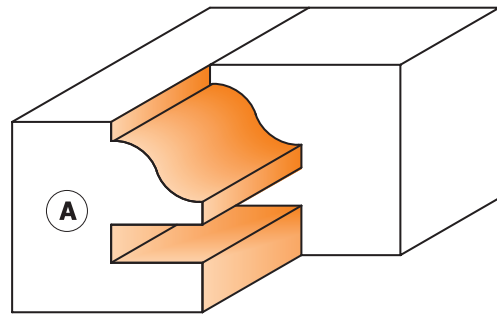

### Optional

### Pair of knives 695.014B

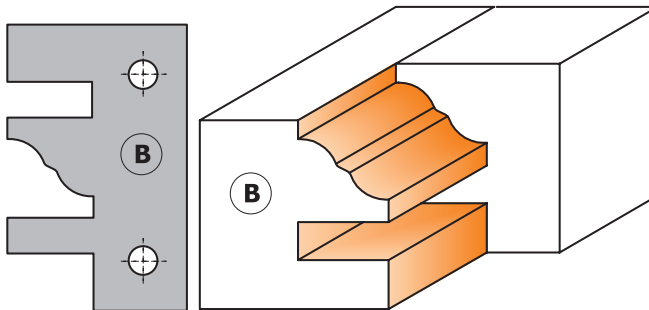

### Pair of knives 695.014C

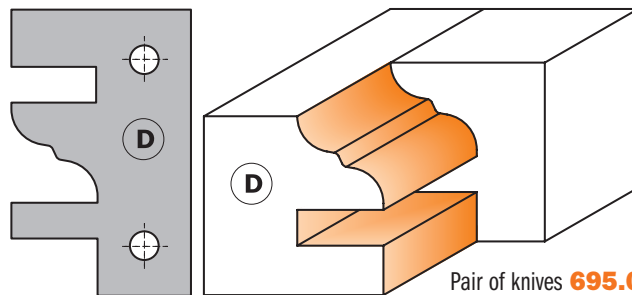
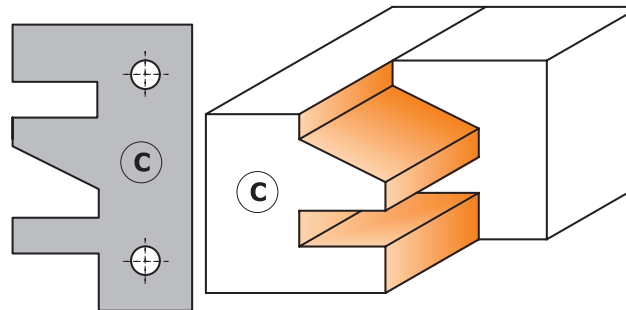

### Pair of knives 695.014D

ORDER NO.	Box	D		B		RPM
		inches	mm	inches	mm	
694.014.31	1	4-23/32	120	1-1/4	31.75	6400~10500

### Spare parts

x2			
695.014A	695.999.39	990.066.00	991.067.00

- Optional: **695.014B** Pair of knives type (B) 40x24.5x2mm  
**695.014C** Pair of knives type (C) 40x24.5x2mm  
**695.014D** Pair of knives type (D) 40x24.5x2mm

# Cutter Heads without Limiters



## 692

CMT cutter heads guarantee excellent performance for all your projects. For use on all types of moulder and spindle moulder machines, profiler and edging machines.

### TECHNICAL DETAILS:

- Hard aluminum or steel alloy cutter head without limiters, highly resistant to tensile and yield stress.
- Pair of universal straight knives included.
- Tools for mechanical feed (MEC).
- Pins for the automatic positioning of the knives.
- Possibility to use knives with a height of 40mm or 50mm (order no. 690).



Supplied in a sturdy plastic carry case. Contains 12 pairs of knives.

### SAFETY TIPS:



The **TW-006** Torque Screwdriver is recommended for the proper fastening of screws (see page 267).

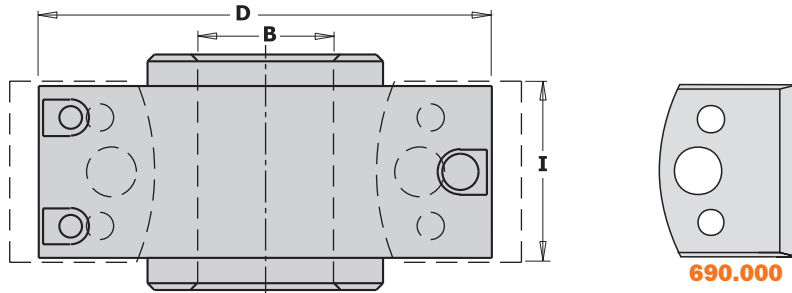
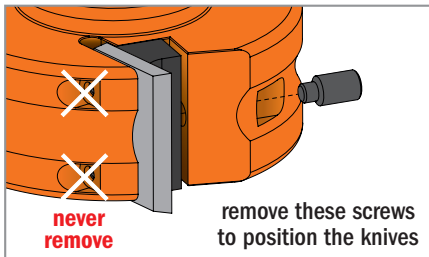

ORDER NO.	Aluminum body	D	B		I	RPM
		inches	inches	mm	inches	
692.078.19	1	3-1/8	3/4	19.05	37/64	7000~9000
692.100.26	1	4	1	25.4	37/64 or 1-31/32	5500~8400
692.100.31	1	4	1-1/4	31.75	37/64 or 1-31/32	5500~8400

### Spare parts

692.999.01	990.064.00	991.064.00
692.999.01	990.064.00	991.064.00
692.999.01	990.064.00	991.064.00

# Pair of Bore Reducers

## 699

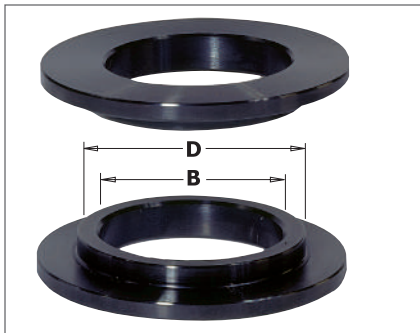

ORDER NO.		DESCRIPTION
699.019.13	10	Pair of bore reducers from 3/4" to 1/2"
699.026.19	10	Pair of bore reducers from 1" to 3/4"
699.030.19	10	Pair of bore reducers from 30mm to 3/4"
699.030.26	10	Pair of bore reducers from 30mm to 1"
699.031.19	10	Pair of bore reducers from 1-1/4" to 3/4"
699.031.26	10	Pair of bore reducers from 1-1/4" to 1"
699.031.30	10	Pair of bore reducers from 1-1/4" to 30mm

To be used only in pairs

# 13-piece Multiprofile Cutter Head Sets without Limiters



Supplied in a sturdy plastic carry case

## 692

This set is ideal for making joints and frames and include 3 essential profiles specifically for creating cabinet doors. An invaluable asset for any professional woodworker. The cutter heads included allow the insertion of knives at a height of either 40mm or 50mm. Both cutter head and knives are packaged in a sturdy plastic case to prevent damage.

**These sets include:**

- 1 cutter head in hard aluminum alloy with pins for the automatic positioning of the knives.
- 13 pairs of knives with a cutting height of 40mm

**SAFETY TIPS:**



The **TW-006** Torque Screwdriver is recommended for the proper fastening of screws (see page 267).

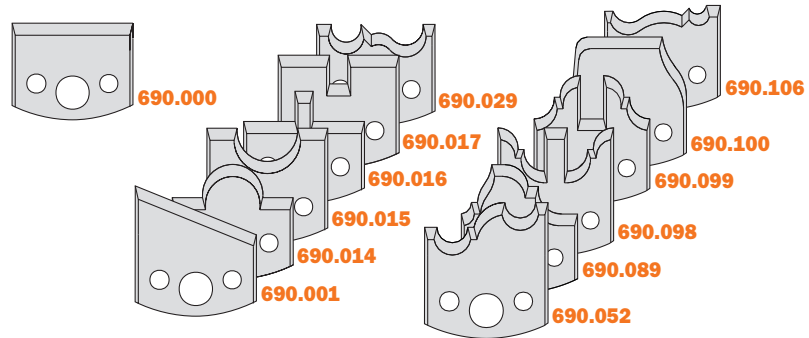

ORDER NO.		D inches	B		I inches	RPM
			inches	mm		
692.013.09	1	3-1/8	3/4	19.05	1-37/64	7000~9000
692.013.10	1	4	1	25.4	1-37/64	5500~8400
692.013.11	1	4	1-1/4	31.75	1-37/64	5500~8400

**Spare parts**

692.999.01	990.064.00	991.064.00
692.999.01	990.064.00	991.064.00
692.999.01	990.064.00	991.064.00



Supplied in a sturdy plastic carry case

## 692

13 of the most popular profiles combined in one sturdy carry case. The featured cutter head fits 40-50mm knives.

**These sets include:**

- 1 cutter head in hard aluminum alloy with pins for the automatic positioning of the knives.
- 13 pairs of knives with a cutting height of 40mm.

**SAFETY TIPS:**



The **TW-006** Torque Screwdriver is recommended for the proper fastening of screws (see page 267).

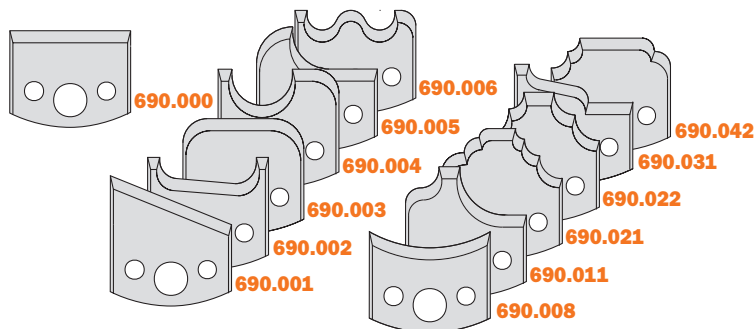

ORDER NO.		D inches	B		I inches	RPM
			inches	mm		
692.013.12	1	3-1/8	3/4	19.05	1-37/64	7000~9000
692.013.13	1	4	1	25.4	1-37/64	5500~8400
692.013.14	1	4	1-1/4	31.75	1-37/64	5500~8400

**Spare parts**

692.999.01	990.064.00	991.064.00
692.999.01	990.064.00	991.064.00
692.999.01	990.064.00	991.064.00



Profile Knives for Insert Shaper System  
 Cutting length=1-37/64" (40mm) - Thickness=5/32" (4mm)

Pack Qty. 10



SP

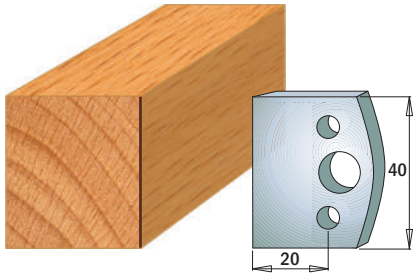

Pair of knives **690.000**

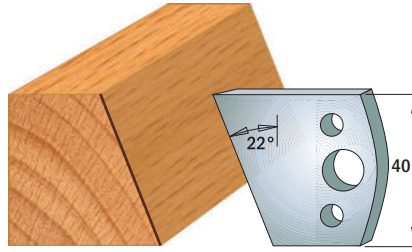

Pair of knives **690.001**

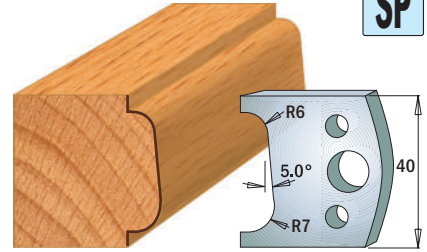

Pair of knives **690.002**

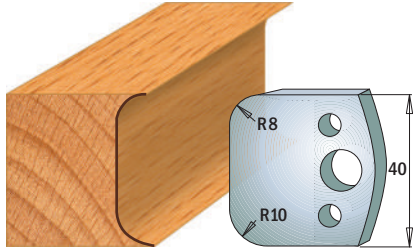

Pair of knives **690.003**

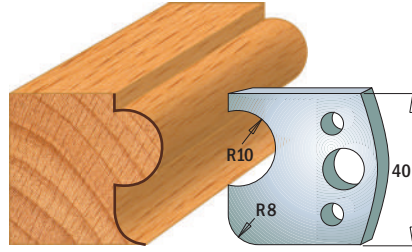

Pair of knives **690.004**

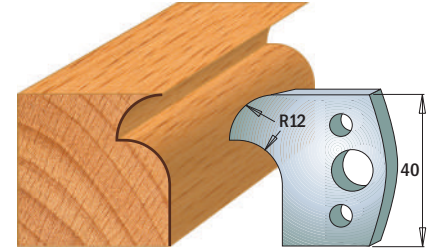

Pair of knives **690.005**

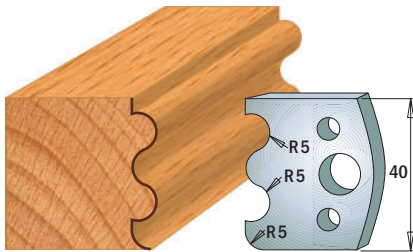

Pair of knives **690.006**

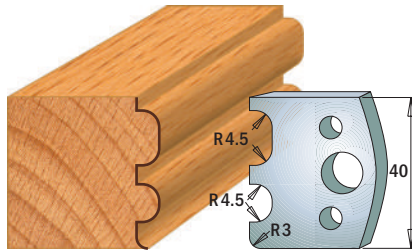

Pair of knives **690.007**

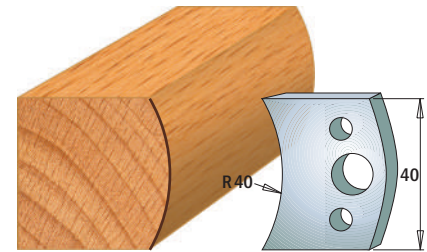

Pair of knives **690.008**

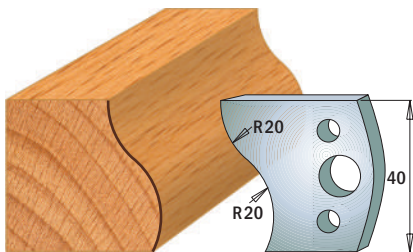

Pair of knives **690.009**

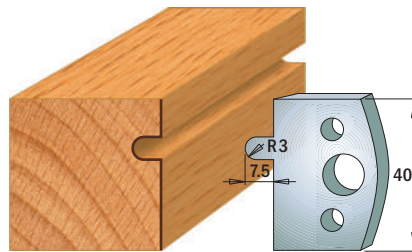

Pair of knives **690.010**

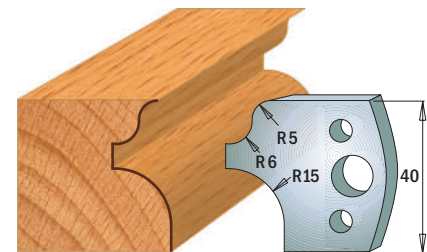

Pair of knives **690.011**

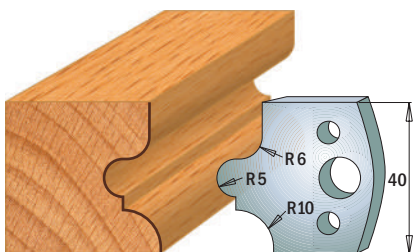

Pair of knives **690.012**

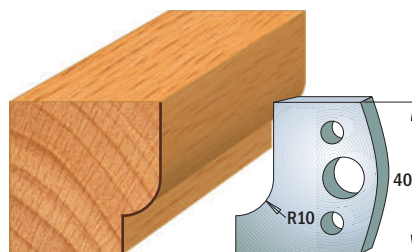

Pair of knives **690.013**

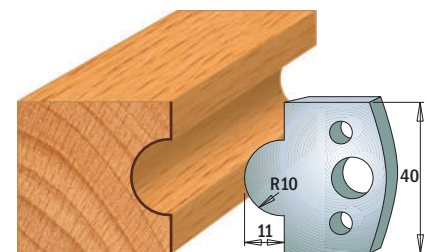

Pair of knives **690.014**

Note: all knives available only in pairs

Drawings are 1:2 scale

Dimension in mm.



Profile Knives for Insert Shaper System  
Cutting length=1-37/64" (40mm) - Thickness=5/32" (4mm)

Pack Qty. 10



SP

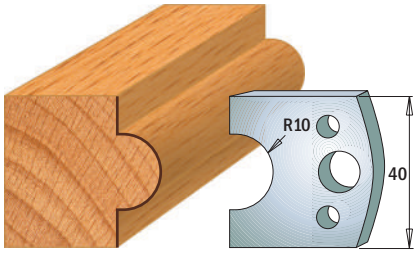

Pair of knives **690.015**

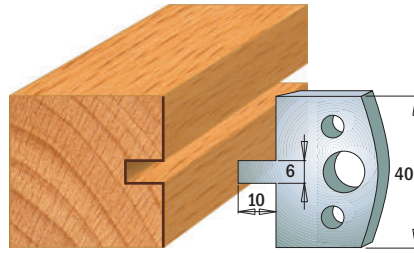

Pair of knives **690.016**

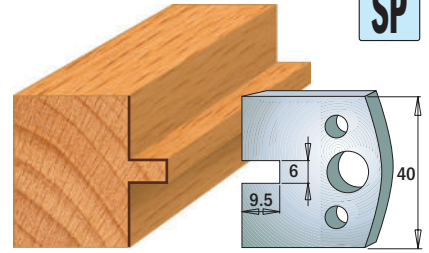

Pair of knives **690.017**

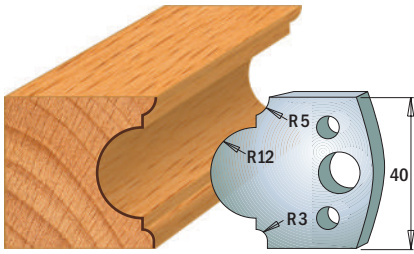

Pair of knives **690.018**

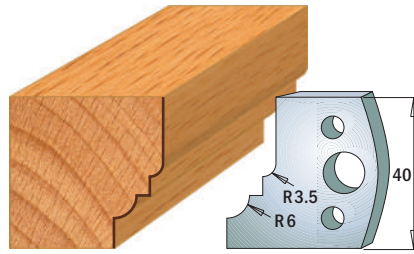

Pair of knives **690.019**

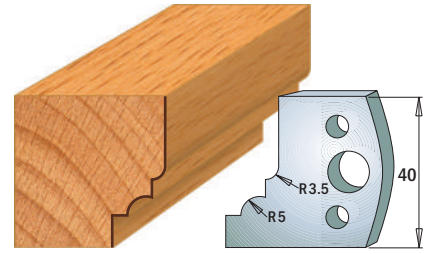

Pair of knives **690.020**

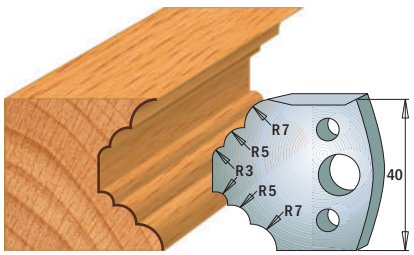

Pair of knives **690.021**

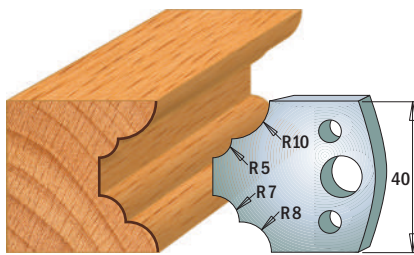

Pair of knives **690.022**

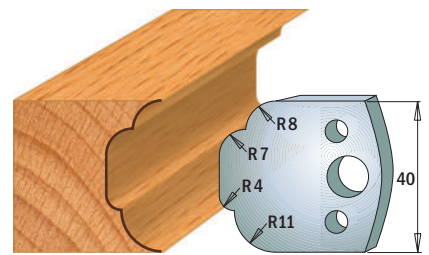

Pair of knives **690.023**

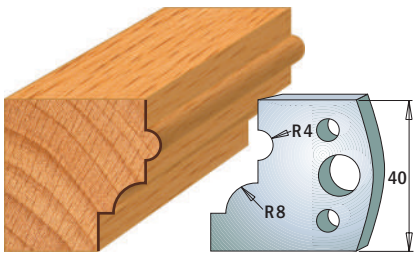

Pair of knives **690.024**

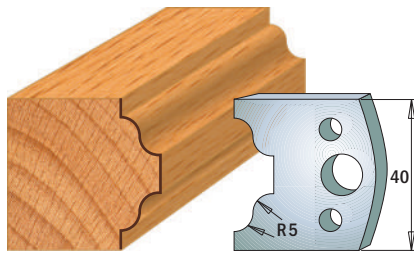

Pair of knives **690.025**

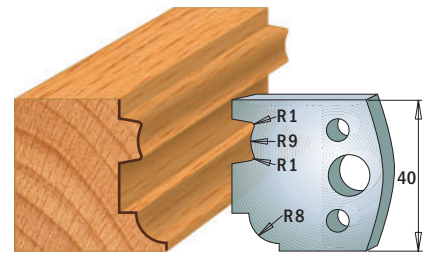

Pair of knives **690.026**

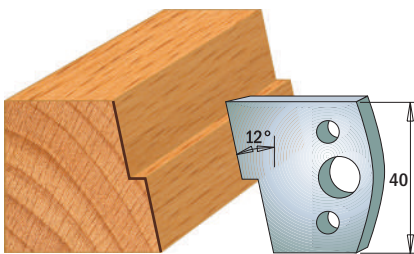

Pair of knives **690.027**

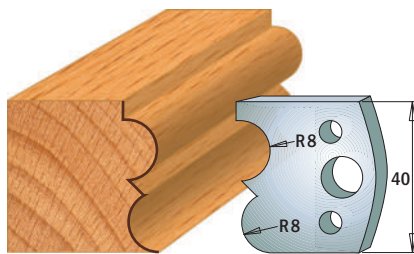

Pair of knives **690.028**

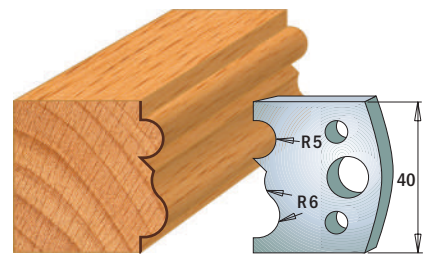

Pair of knives **690.029**

Note: all knives available only in pairs

Drawings are 1:2 scale

Dimension in mm.



Profile Knives for Insert Shaper System  
Cutting length=1-37/64" (40mm) - Thickness=5/32" (4mm)

Pack Qty. 10



SP

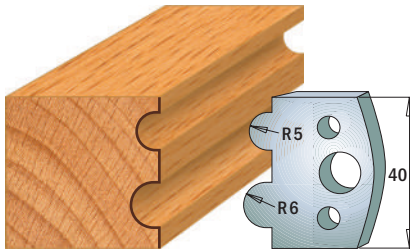

Pair of knives **690.030**

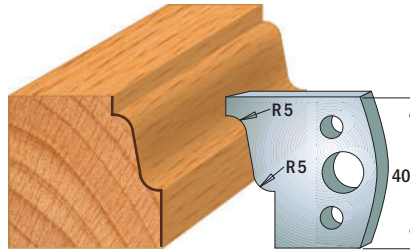

Pair of knives **690.031**

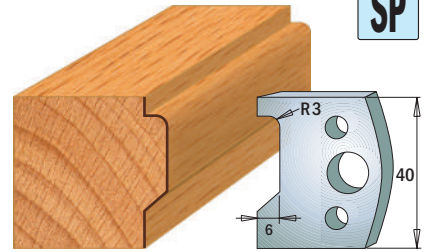

Pair of knives **690.032**

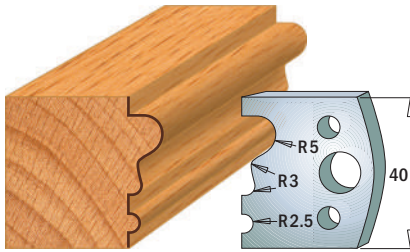

Pair of knives **690.033**

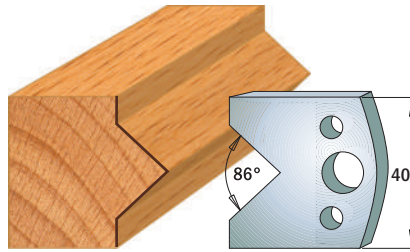

Pair of knives **690.034**

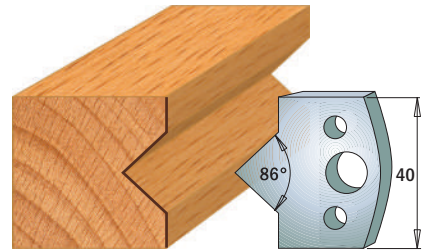

Pair of knives **690.035**

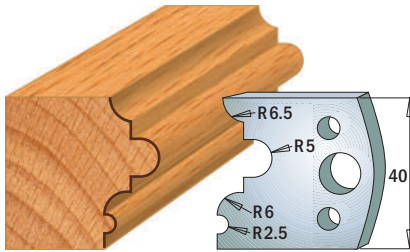

Pair of knives **690.036**

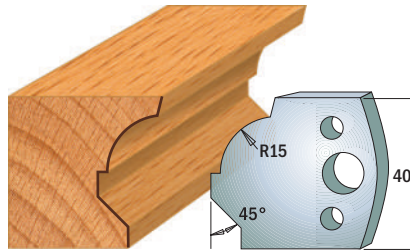

Pair of knives **690.037**

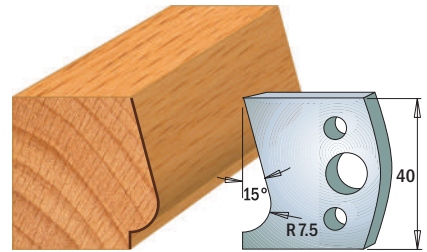

Pair of knives **690.038**

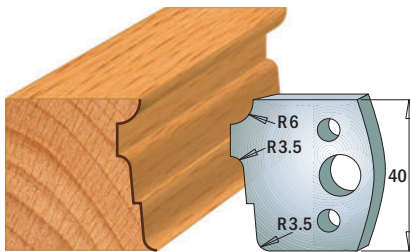

Pair of knives **690.039**

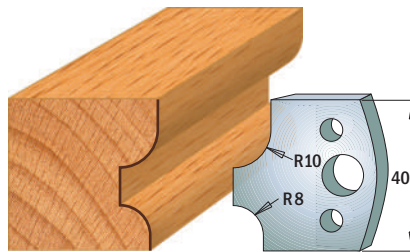

Pair of knives **690.040**

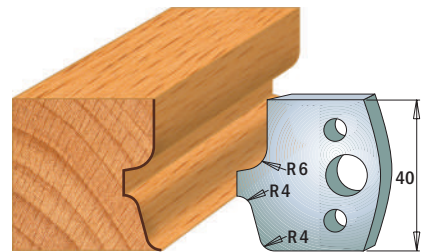

Pair of knives **690.041**

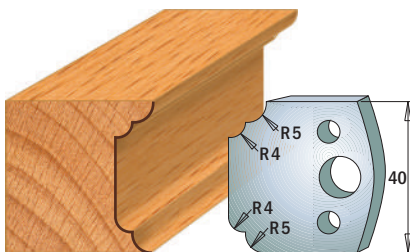

Pair of knives **690.042**

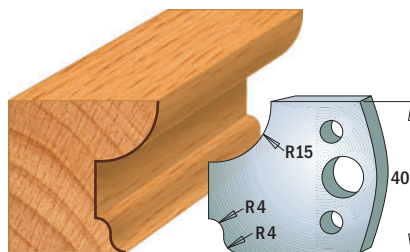

Pair of knives **690.043**

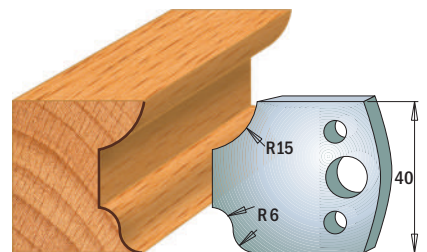

Pair of knives **690.044**

Note: all knives available only in pairs

Drawings are 1:2 scale

Dimension in mm.

# Profile Knives for Insert Shaper System

Cutting length=1-37/64" (40mm) - Thickness=5/32" (4mm)

Pack Qty. 10



SP

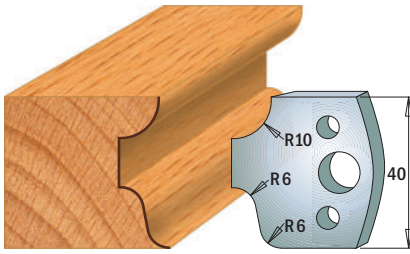

Pair of knives **690.045**

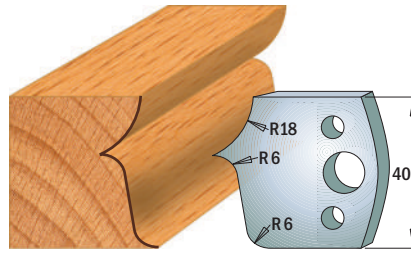

Pair of knives **690.046**

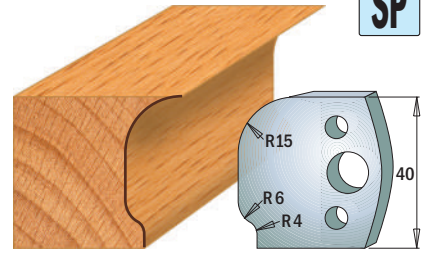

Pair of knives **690.047**

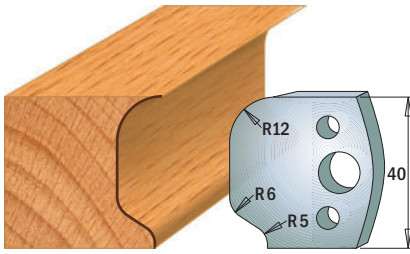

Pair of knives **690.048**

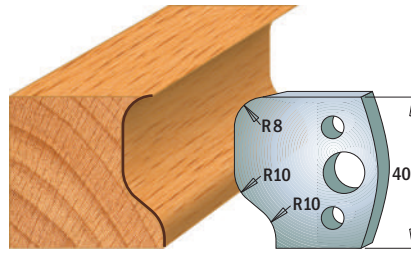

Pair of knives **690.049**

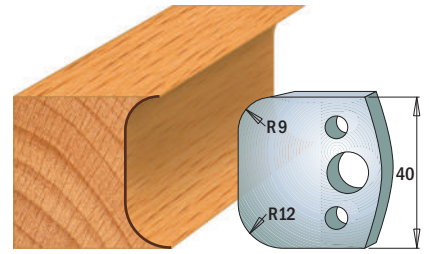

Pair of knives **690.050**

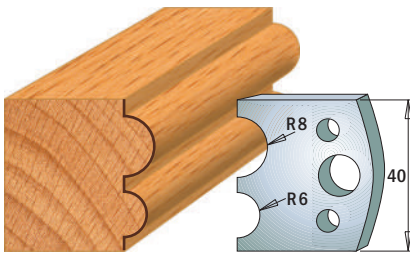

Pair of knives **690.051**

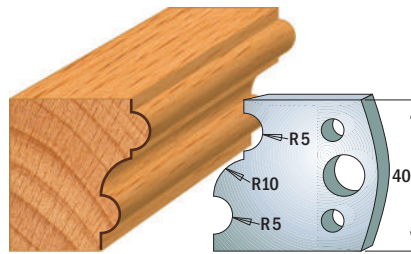

Pair of knives **690.052**

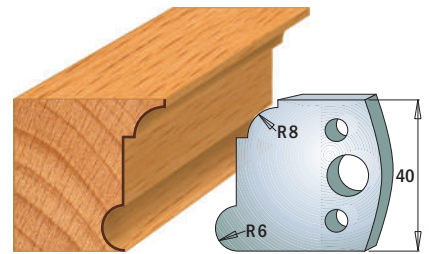

Pair of knives **690.053**

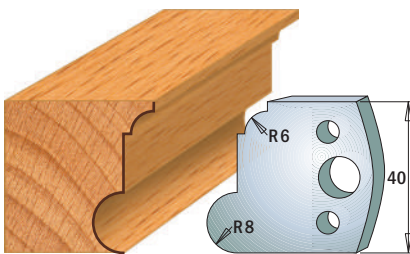

Pair of knives **690.054**

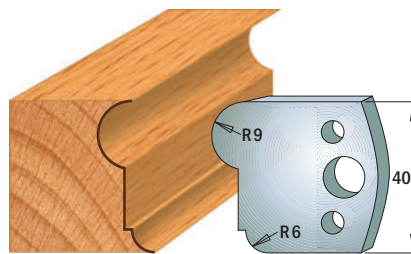

Pair of knives **690.055**

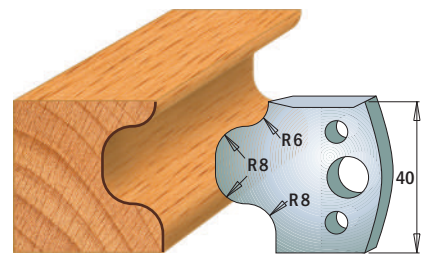

Pair of knives **690.056**

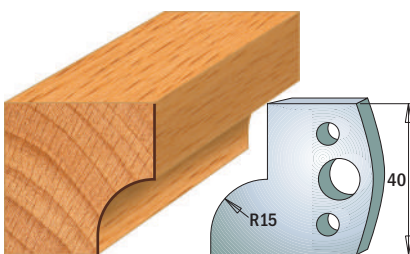

Pair of knives **690.057**

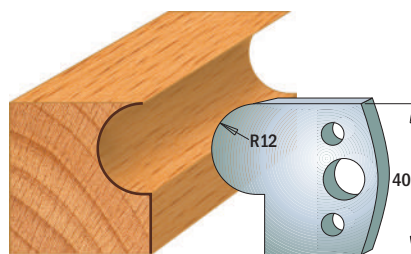

Pair of knives **690.058**

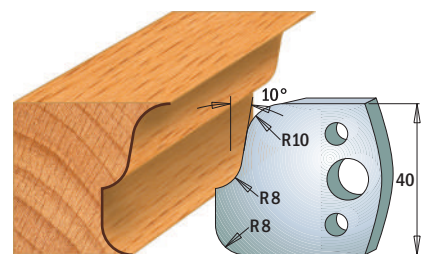

Pair of knives **690.059**

Note: all knives available only in pairs

Drawings are 1:2 scale

Dimension in mm.



# Profile Knives for Insert Shaper System

Cutting length=1-37/64" (40mm) - Thickness=5/32" (4mm)

Pack Qty. 10



SP

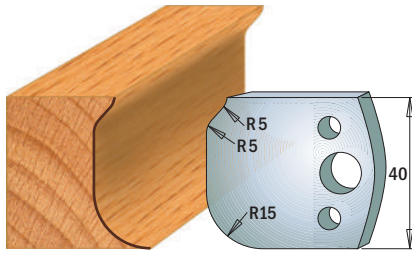

Pair of knives **690.060**

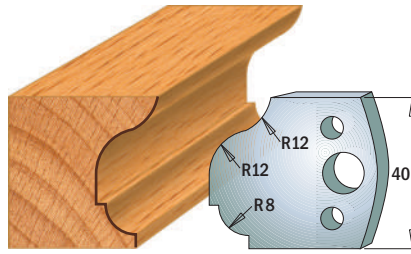

Pair of knives **690.061**

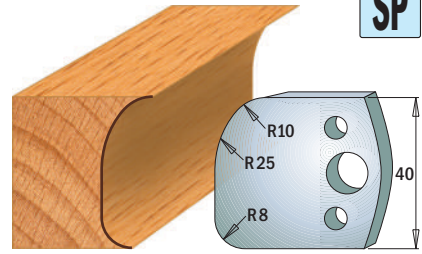

Pair of knives **690.062**

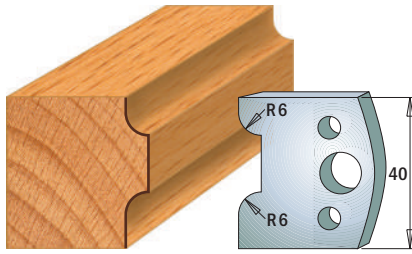

Pair of knives **690.063**

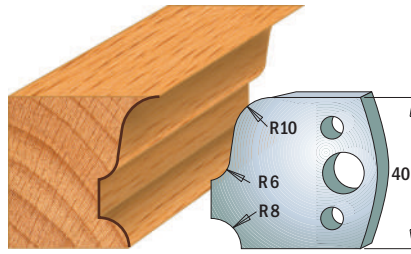

Pair of knives **690.064**

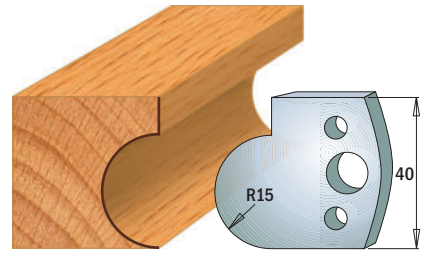

Pair of knives **690.065**

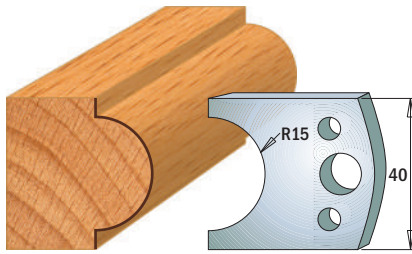

Pair of knives **690.066**

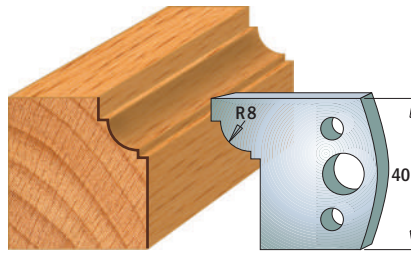

Pair of knives **690.067**

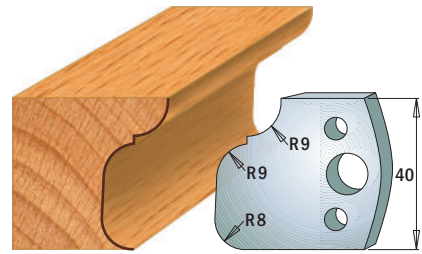

Pair of knives **690.068**

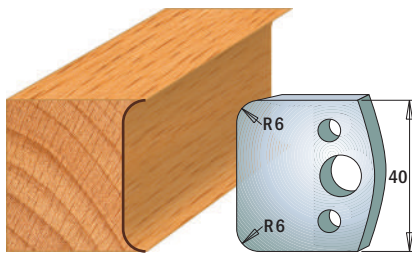

Pair of knives **690.069**

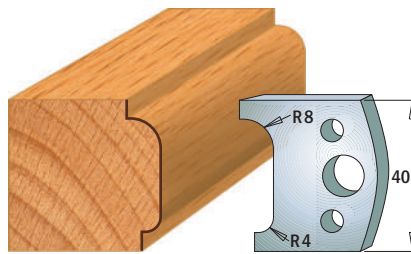

Pair of knives **690.070**

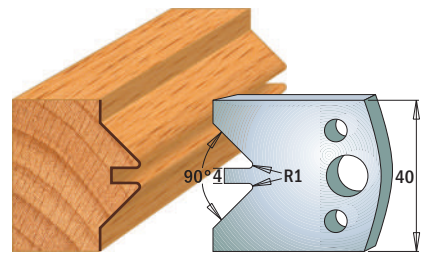

Pair of knives **690.071**

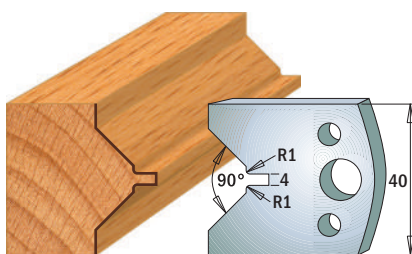

Pair of knives **690.072**

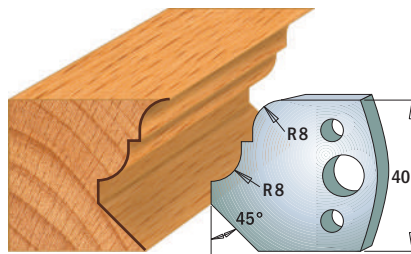

Pair of knives **690.073**

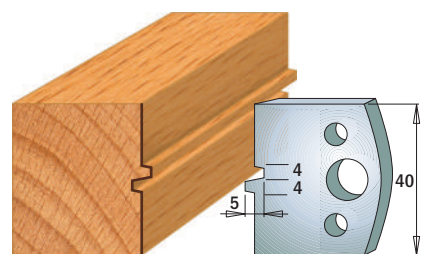

Pair of knives **690.074**

Note: all knives available only in pairs

Drawings are 1:2 scale

Dimension in mm.



Profile Knives for Insert Shaper System  
 Cutting length=1-37/64" (40mm) - Thickness=5/32" (4mm)

Pack Qty. 10



SP

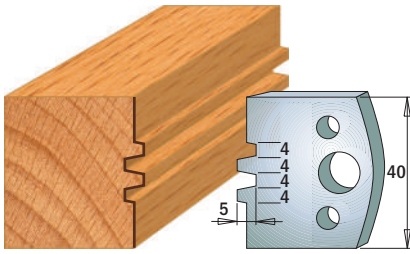

Pair of knives **690.075**

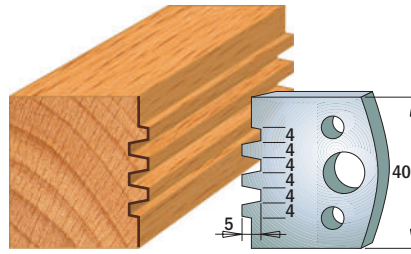

Pair of knives **690.076**

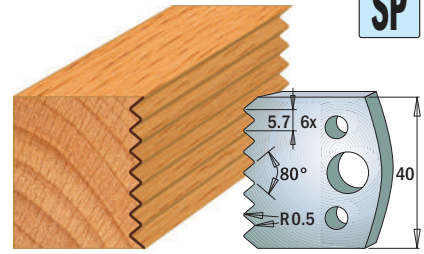

Pair of knives **690.077**

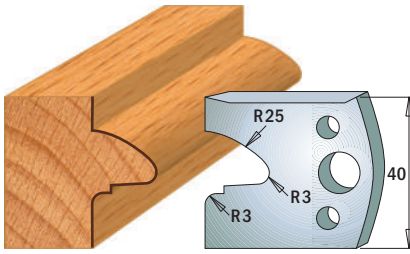

Pair of knives **690.078**

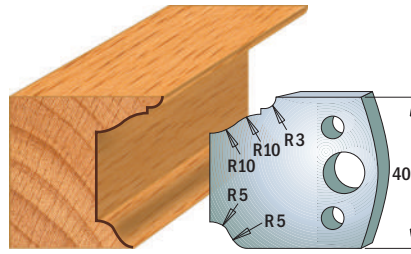

Pair of knives **690.079**

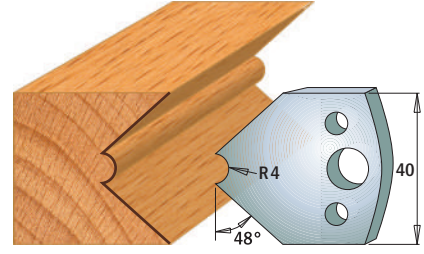

Pair of knives **690.080**

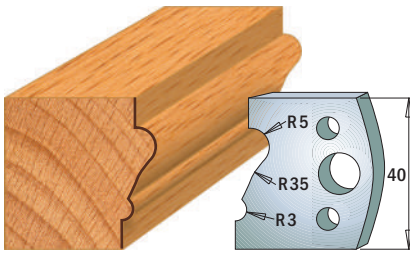

Pair of knives **690.081**

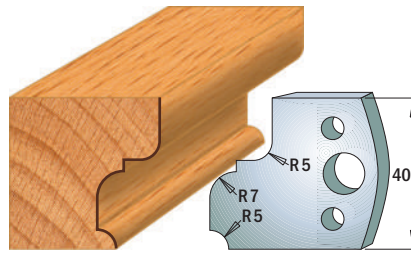

Pair of knives **690.082**

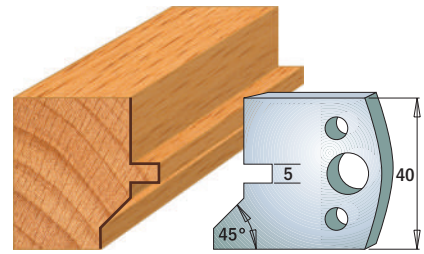

Pair of knives **690.083**

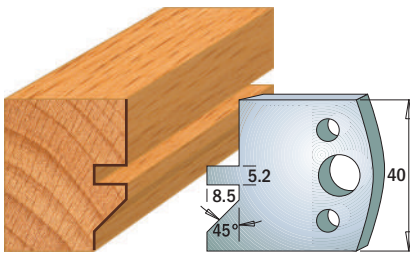

Pair of knives **690.084**

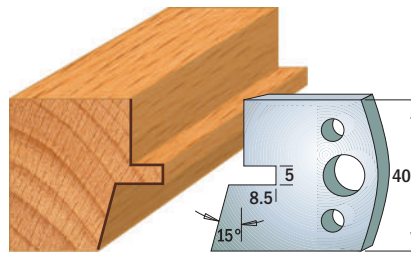

Pair of knives **690.085**

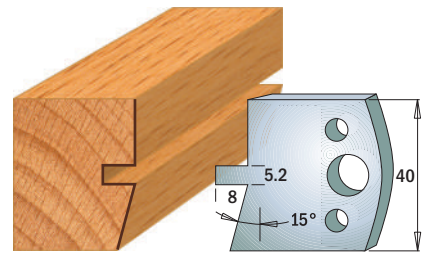

Pair of knives **690.086**

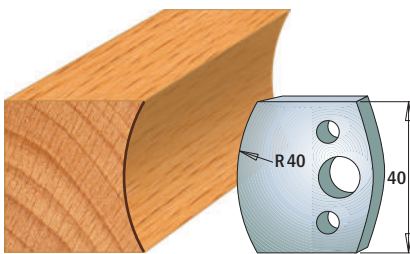

Pair of knives **690.087**

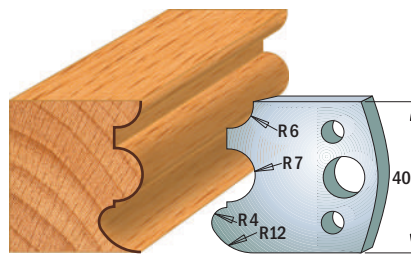

Pair of knives **690.088**

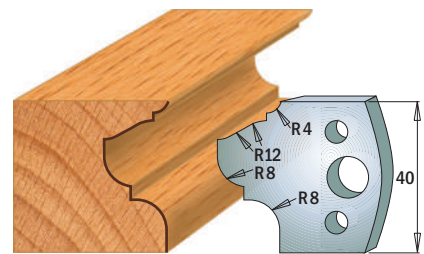

Pair of knives **690.089**

Note: all knives available only in pairs

Drawings are 1:2 scale

Dimension in mm.



# Profile Knives for Insert Shaper System

Cutting length=1-37/64" (40mm) - Thickness=5/32" (4mm)

Pack Qty. 10



SP

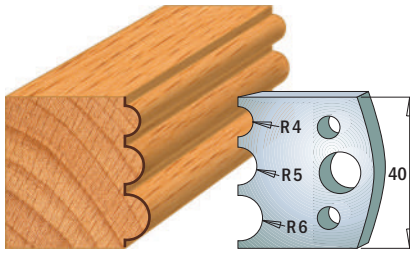

Pair of knives **690.090**

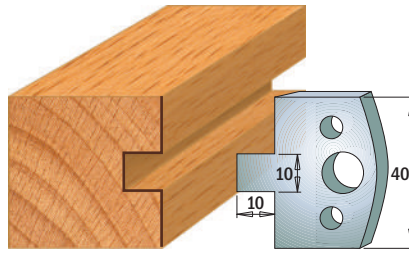

Pair of knives **690.091**

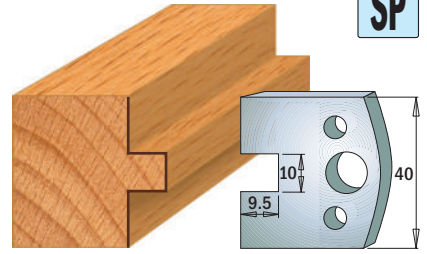

Pair of knives **690.092**

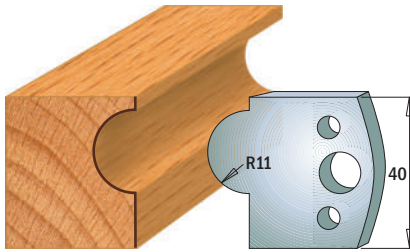

Pair of knives **690.093**

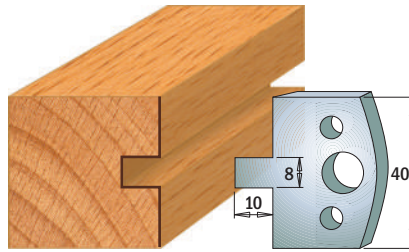

Pair of knives **690.094**

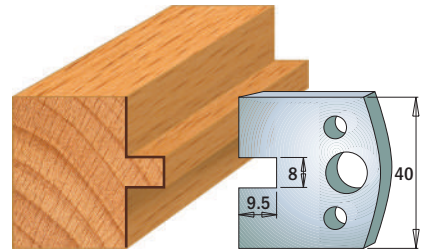

Pair of knives **690.095**

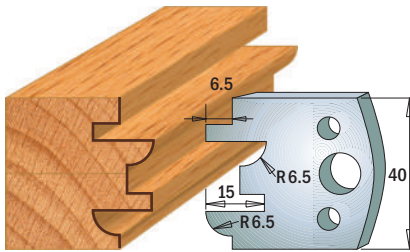

Pair of knives **690.096**

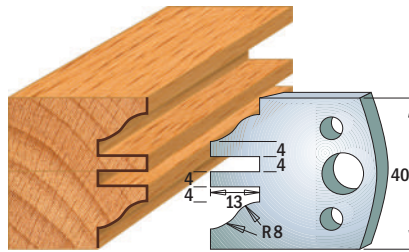

Pair of knives **690.097**

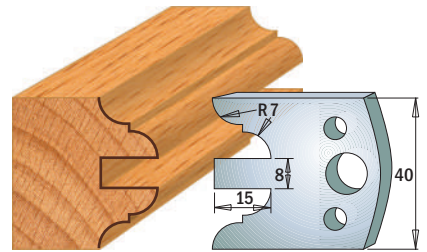

Pair of knives **690.098**

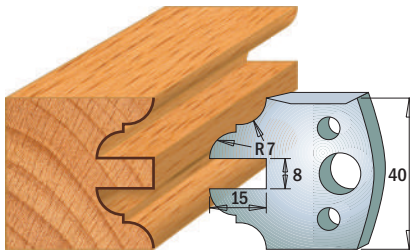

Pair of knives **690.099**

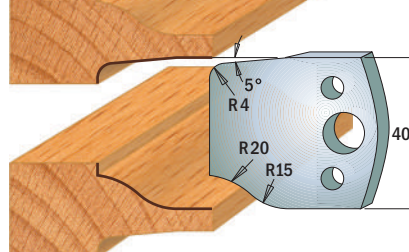

Pair of knives **690.100**

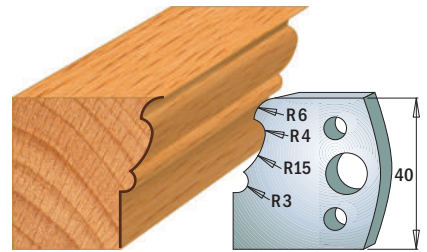

Pair of knives **690.101**

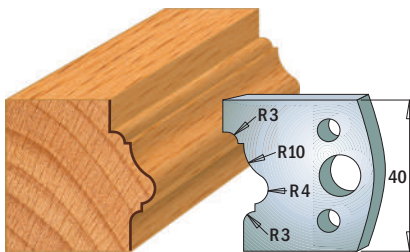

Pair of knives **690.102**

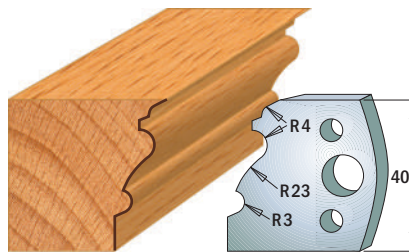

Pair of knives **690.103**

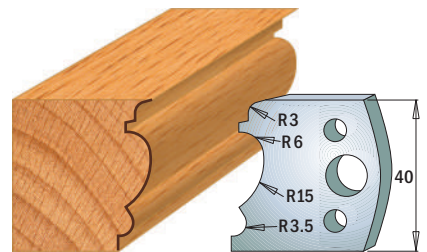

Pair of knives **690.104**

Note: all knives available only in pairs

Drawings are 1:2 scale

Dimension in mm.



# Profile Knives for Insert Shaper System

Cutting length=1-37/64" (40mm) - Thickness=5/32" (4mm)

Pack Qty. 10



SP

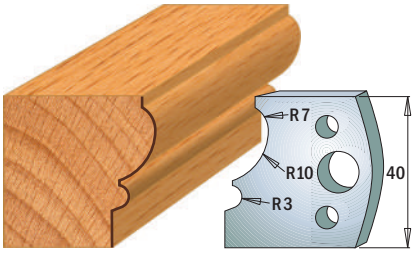

Pair of knives **690.105**

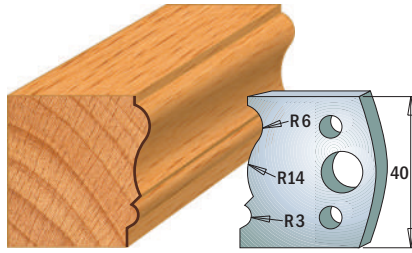

Pair of knives **690.106**

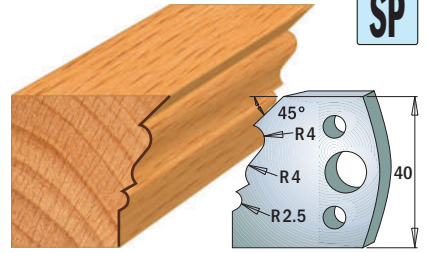

Pair of knives **690.107**

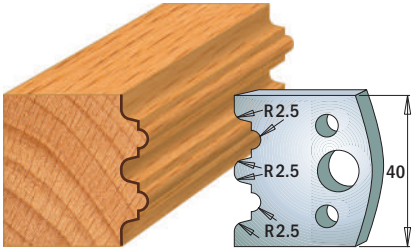

Pair of knives **690.108**

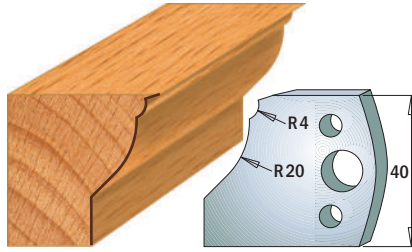

Pair of knives **690.109**

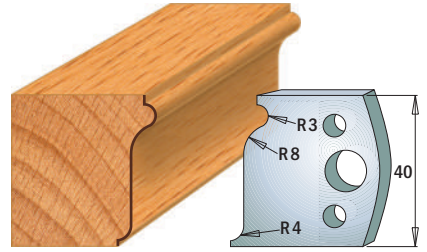

Pair of knives **690.110**

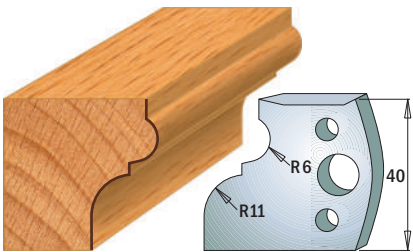

Pair of knives **690.111**

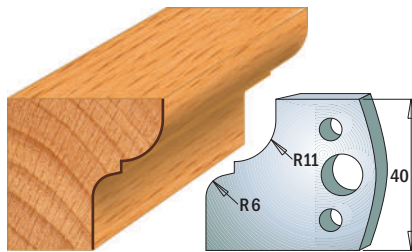

Pair of knives **690.112**

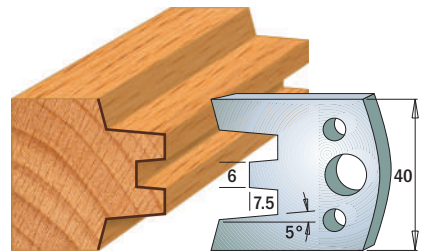

Pair of knives **690.113**

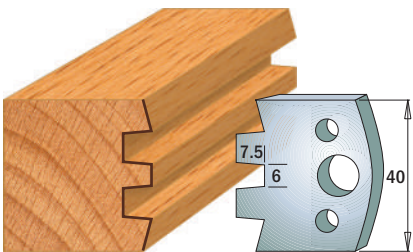

Pair of knives **690.114**

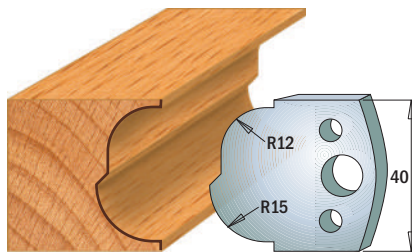

Pair of knives **690.115**

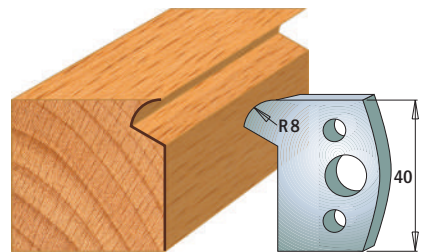

Pair of knives **690.116**

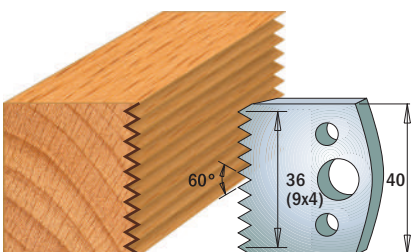

Pair of knives **690.117**

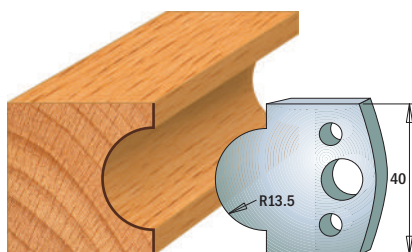

Pair of knives **690.118**

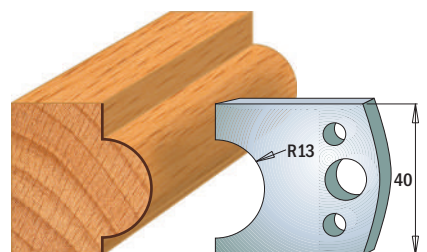

Pair of knives **690.119**

Note: all knives available only in pairs

Drawings are 1:2 scale

Dimension in mm.



Profile Knives for Insert Shaper System  
Cutting length=1-37/64" (40mm) - Thickness=5/32" (4mm)

Pack Qty. 10



SP

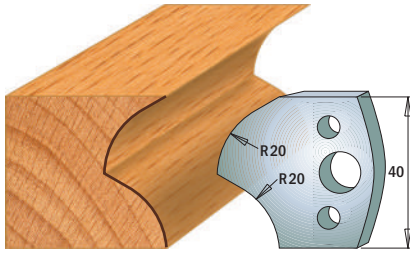

Pair of knives **690.120**

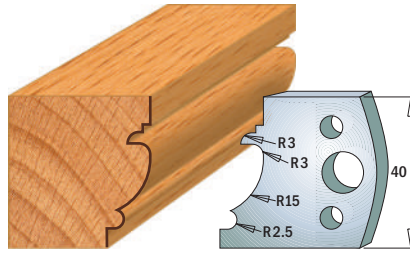

Pair of knives **690.121**

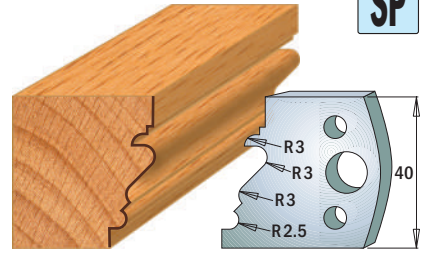

Pair of knives **690.122**

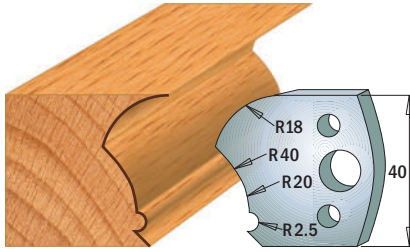

Pair of knives **690.123**

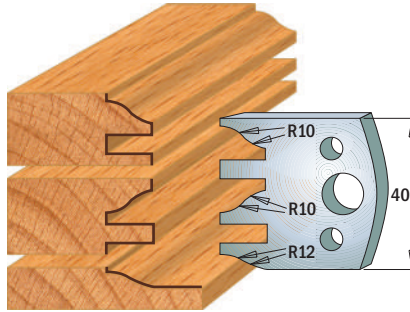

Pair of knives **690.124**

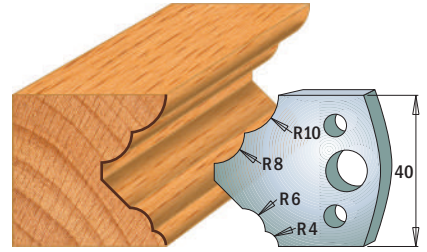

Pair of knives **690.125**

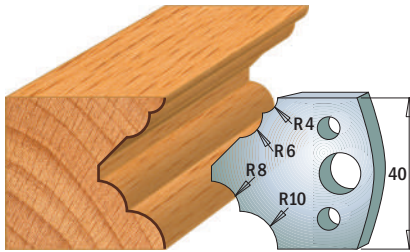

Pair of knives **690.126**

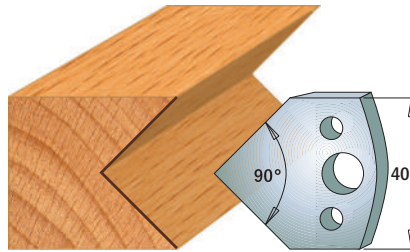

Pair of knives **690.127**

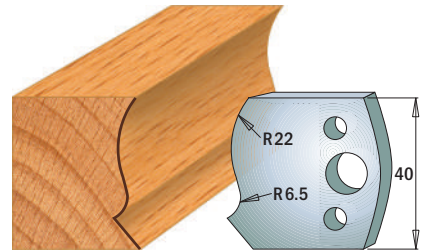

Pair of knives **690.128**

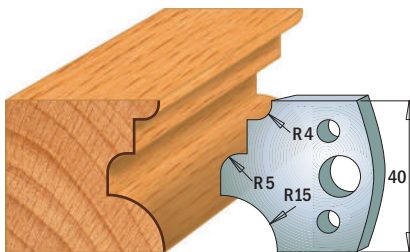

Pair of knives **690.129**

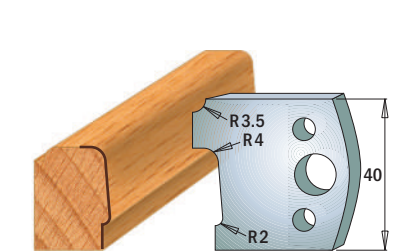

Pair of knives **690.130**

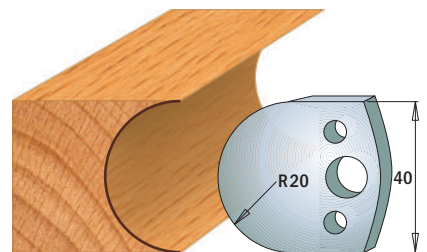

Pair of knives **690.131**

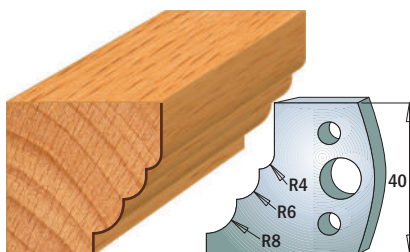

Pair of knives **690.132**

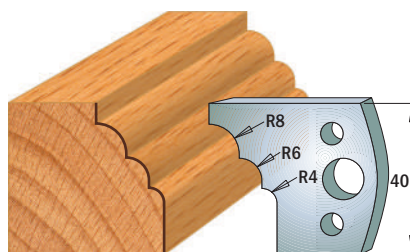

Pair of knives **690.133**

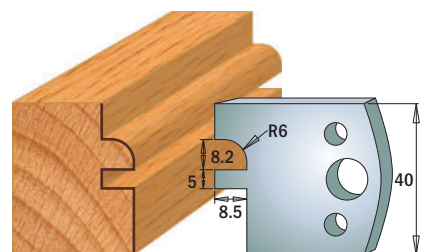

Pair of knives **690.134**

Note: all knives available only in pairs

Drawings are 1:2 scale

Dimension in mm.



Profile Knives for Insert Shaper System  
 Cutting length=1-37/64" (40mm) - Thickness=5/32" (4mm)

Pack Qty. 10



SP

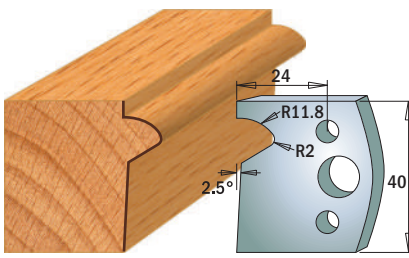

Pair of knives **690.135**

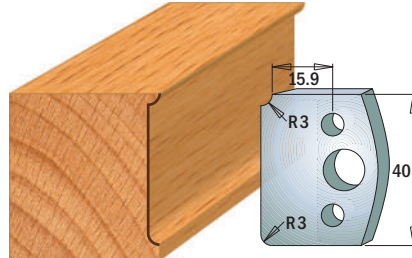

Pair of knives **690.170**

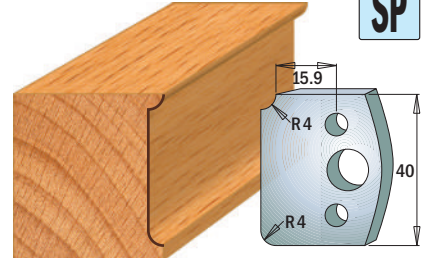

Pair of knives **690.171**

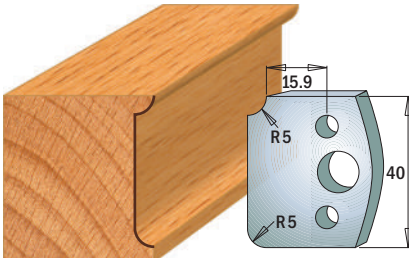

Pair of knives **690.172**

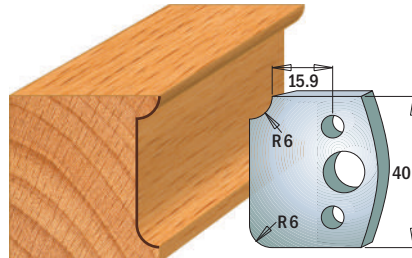

Pair of knives **690.173**

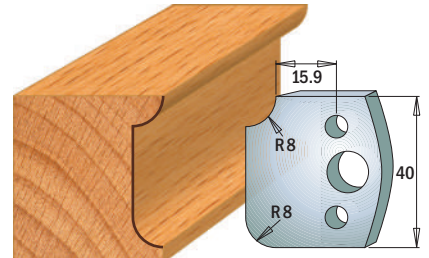

Pair of knives **690.174**

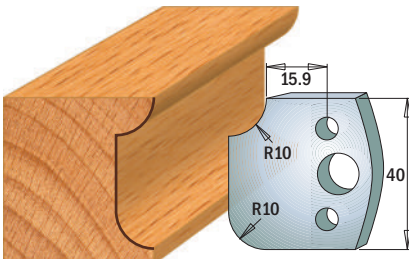

Pair of knives **690.175**

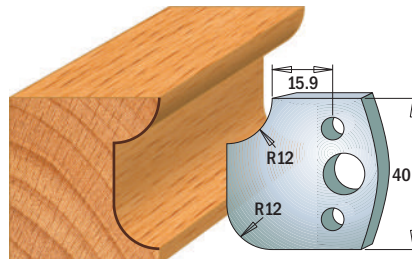

Pair of knives **690.176**

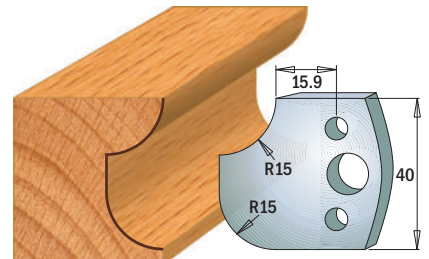

Pair of knives **690.177**

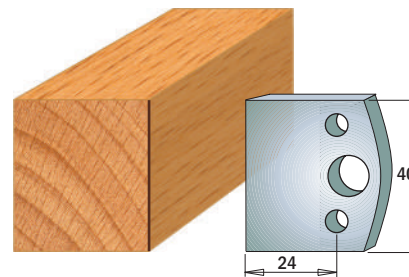

Pair of knives **690.192**

Profile Knives for Insert Shaper System

Cutting length=1-31/32" (50mm) - Thickness=5/32" (4mm) Pack Qty. 10

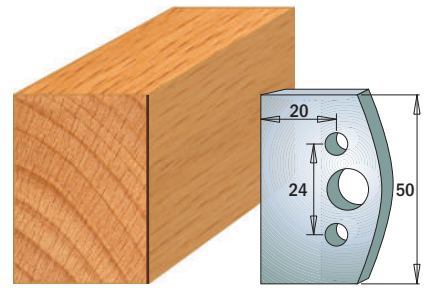

Pair of knives **690.500**

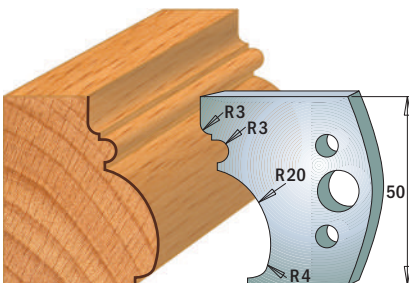

Pair of knives **690.501**

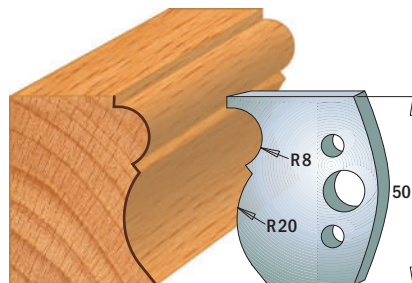

Pair of knives **690.502**

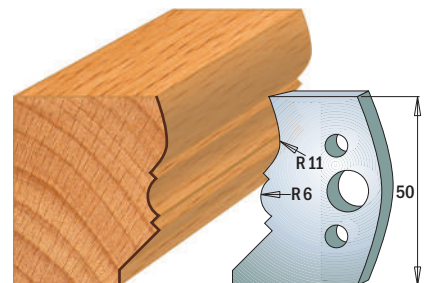

Pair of knives **690.503**

Note: all knives available only in pairs

Drawings are 1:2 scale

Dimension in mm.



Profile Knives for Insert Shaper System  
Cutting length=1-31/32" (50mm) - Thickness=5/32" (4mm)

Pack Qty. 10



SP

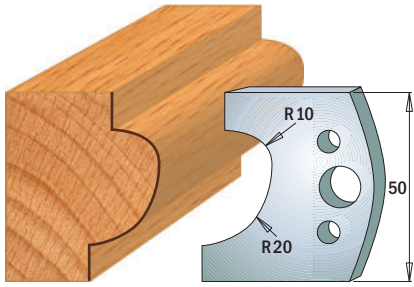

Pair of knives **690.504**

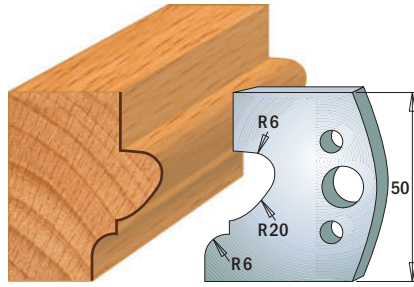

Pair of knives **690.505**

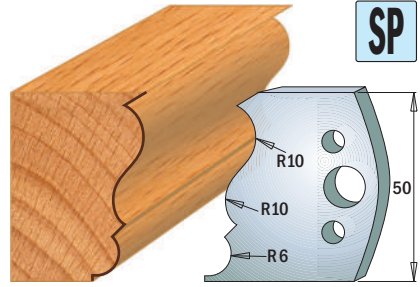

Pair of knives **690.506**

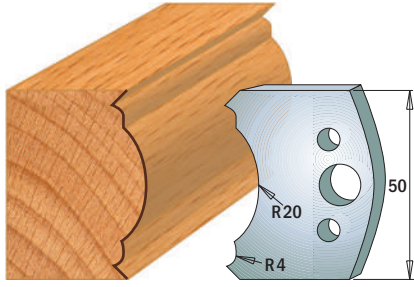

Pair of knives **690.507**

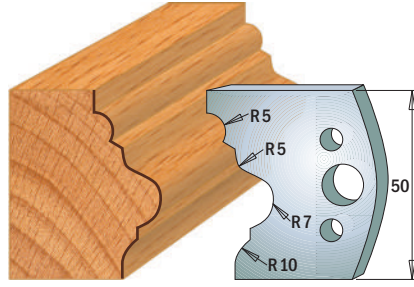

Pair of knives **690.508**

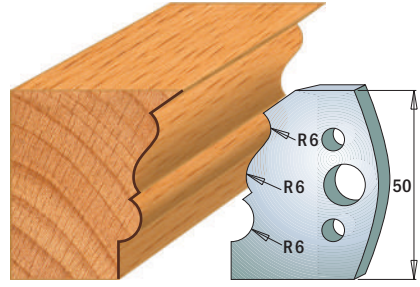

Pair of knives **690.509**

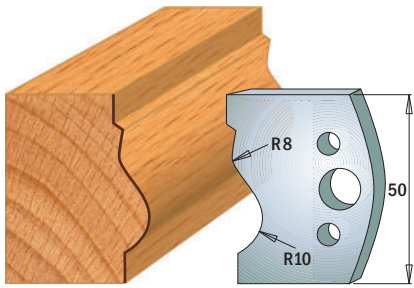

Pair of knives **690.510**

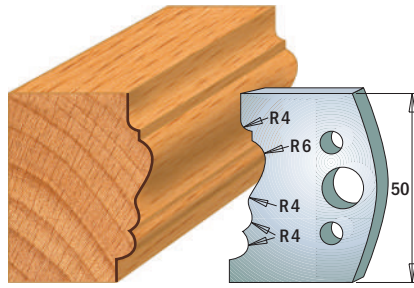

Pair of knives **690.511**

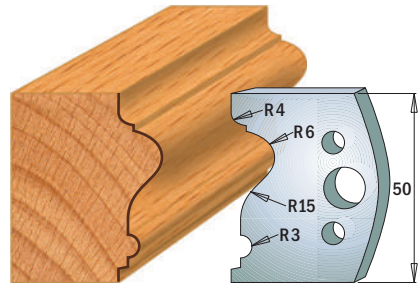

Pair of knives **690.512**

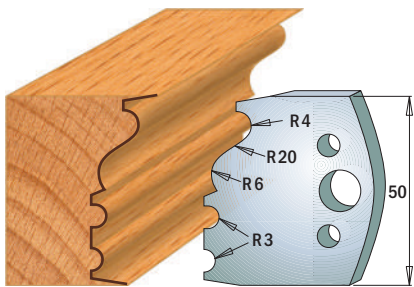

Pair of knives **690.513**

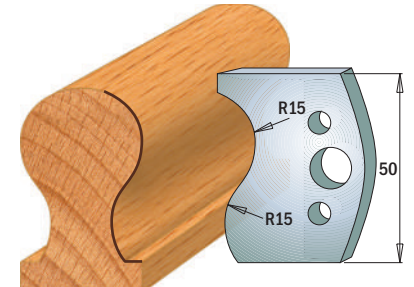

Pair of knives **690.514**

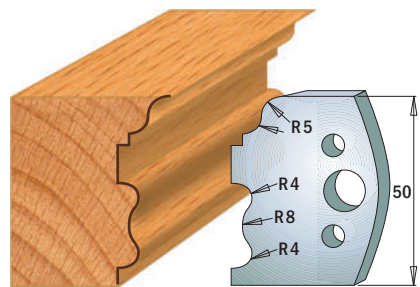

Pair of knives **690.515**

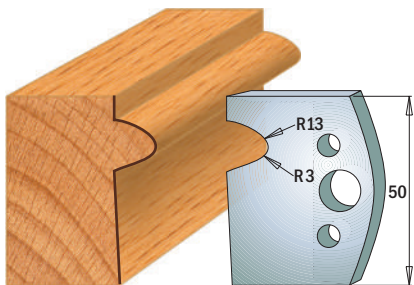

Pair of knives **690.516**

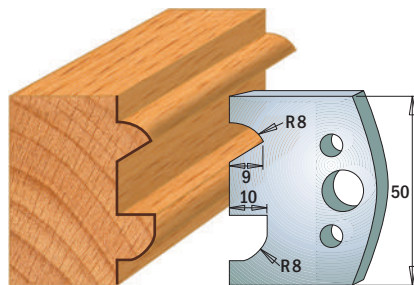

Pair of knives **690.517**

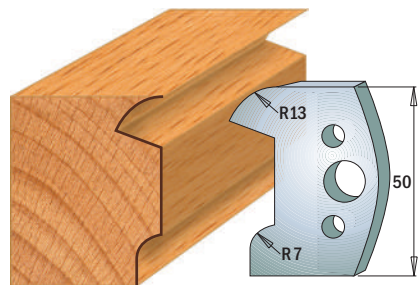

Pair of knives **690.518**

Note: all knives available only in pairs

Drawings are 1:2 scale

Dimension in mm.



Profile Knives for Insert Shaper System  
Cutting length=1-31/32" (50mm) - Thickness=5/32" (4mm)

Pack Qty. 10



SP

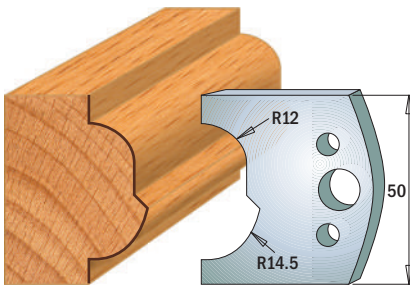

Pair of knives **690.519**

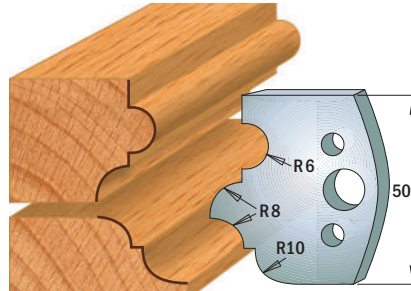

Pair of knives **690.520**

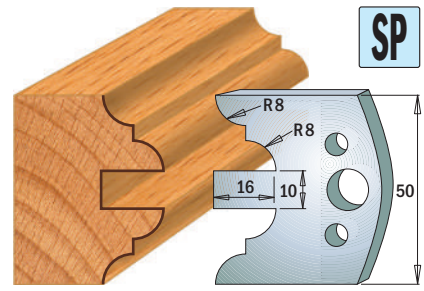

Pair of knives **690.522**

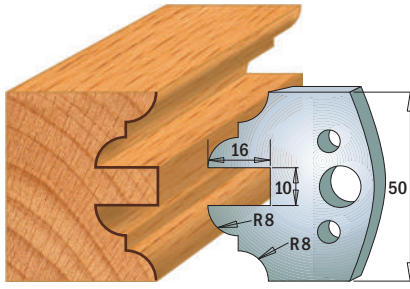

Pair of knives **690.523**

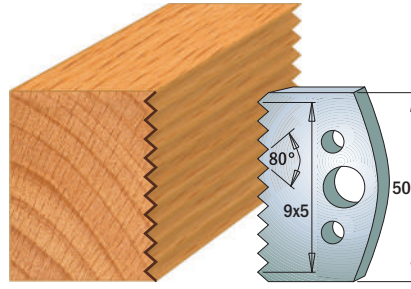

Pair of knives **690.524**

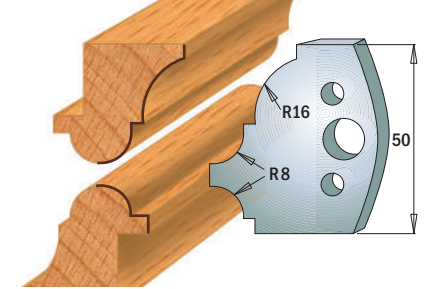

Pair of knives **690.541**

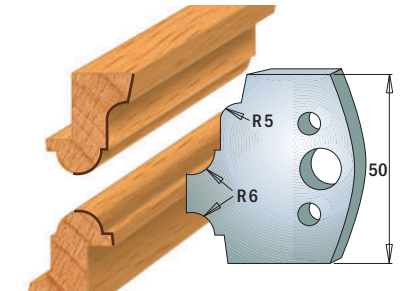

Pair of knives **690.542**

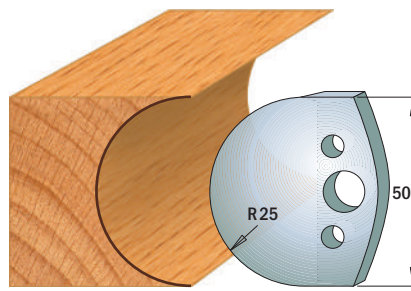

Pair of knives **690.543**

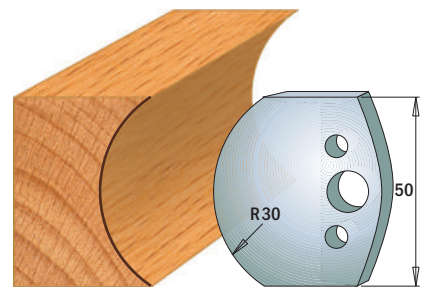

Pair of knives **690.544**

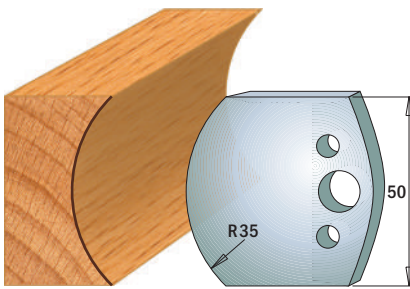

Pair of knives **690.545**

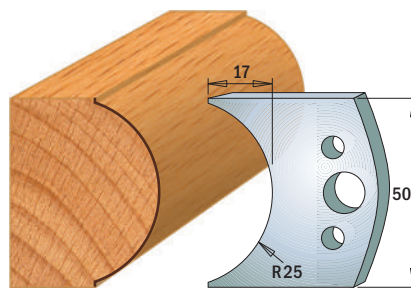

Pair of knives **690.546**

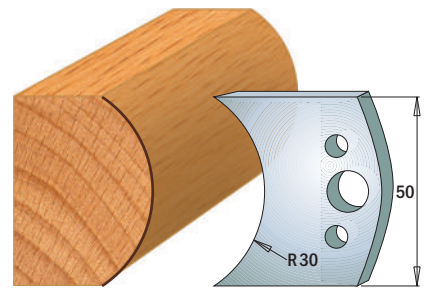

Pair of knives **690.547**

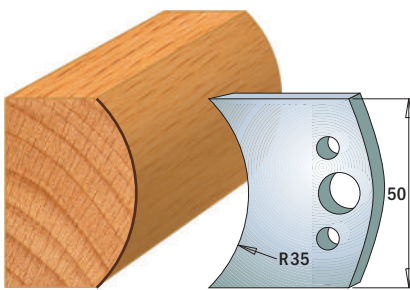

Pair of knives **690.548**

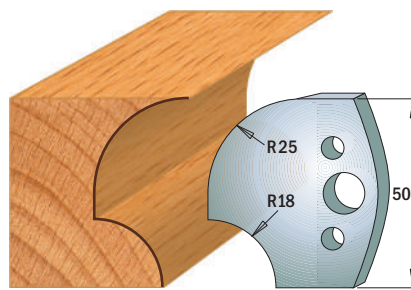

Pair of knives **690.549**

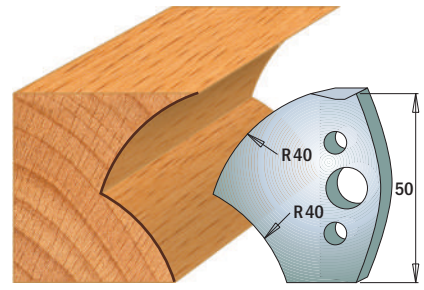

Pair of knives **690.550**

Note: all knives available only in pairs

Drawings are 1:2 scale

Dimension in mm.

# Profile Knives for Insert Shaper System

Cutting length=1-31/32" (50mm) - Thickness=5/32" (4mm)

Pack Qty. 10



SP

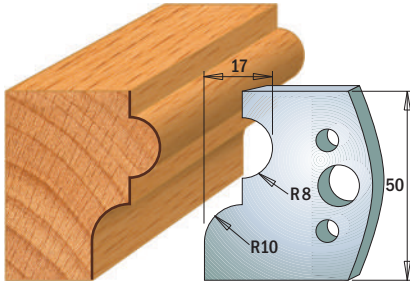

Pair of knives **690.551**

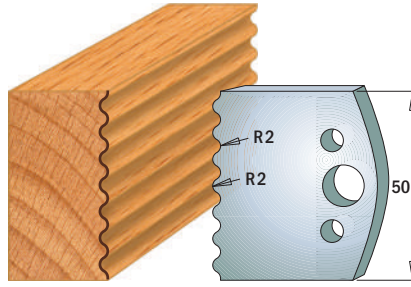

Pair of knives **690.552**

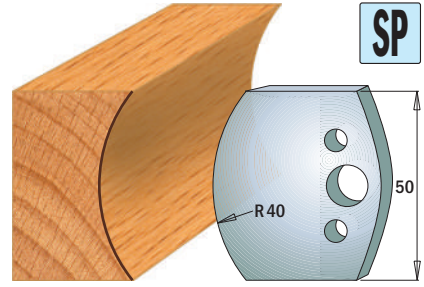

Pair of knives **690.553**

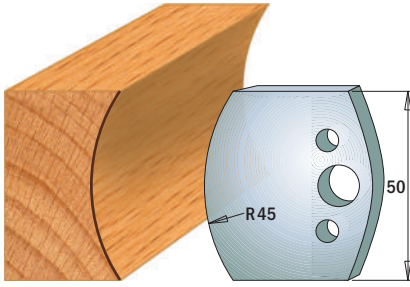

Pair of knives **690.554**

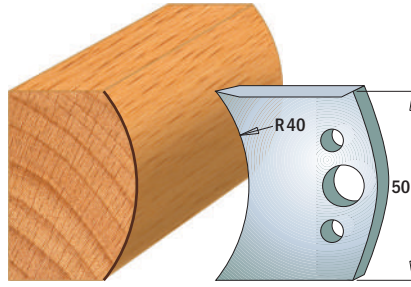

Pair of knives **690.555**

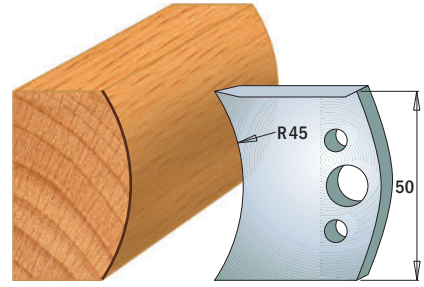

Pair of knives **690.556**

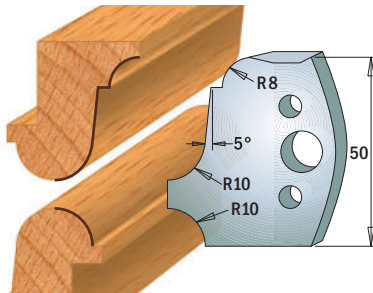

Pair of knives **690.557**

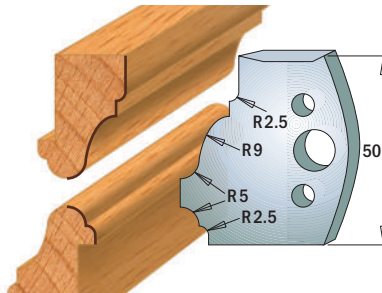

Pair of knives **690.558**

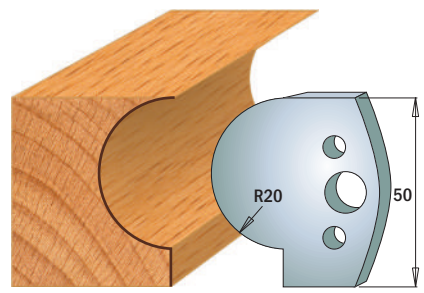

Pair of knives **690.562**

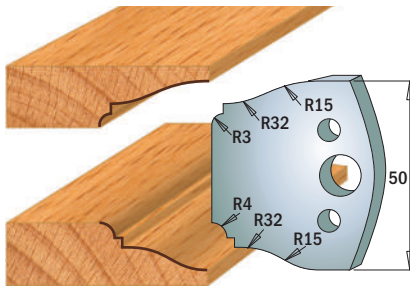

Pair of knives **690.568**

Note: all knives available only in pairs  
 Drawings are 1:2 scale  
 Dimension in mm.

## 690 BLANK KNIVES (TO BE SHARPENED)

SP

	ORDER NO.		LB		I		L	MAX PROFILE
			inches	mm	inches	mm	inches	inches
	<b>690.193</b>	10	1-9/32	32.5	1-37/64	40	1-3/4	23/32
	<b>690.599</b>	10	1-11/32	34	2	50	1-13/16	51/64



**794**

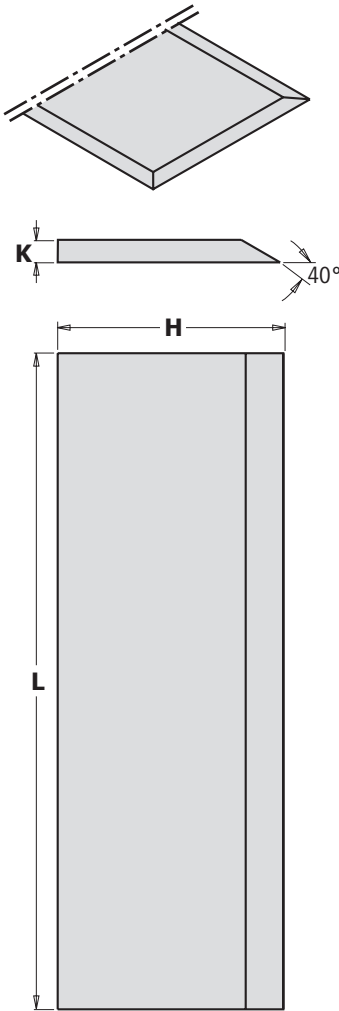

IN QUADROPACK PACKAGING

ORDER NO. HSS	L inches	H inches	K inches	KNIVES PER SET
794.101	4	5/8	1/8	3
794.151	6	5/8	1/8	3
794.152	6	3/4	1/8	3
794.161	6-1/8	5/8	3/32	3
794.202	8	5/8	1/8	3
794.203	8	3/4	1/8	3
794.302	12	3/4	1/8	3
794.303	12	7/8	1/8	3
794.321	12-1/2	11/16	1/8	3
794.381	15	1	1/8	3
794.511	20	1	1/8	1
794.941 ■	37	1-1/8	1/8	1
794.942 ■	37	1-1/4	5/32	1

■ Until stock last

**792** PLANER & JOINTER KNIVES HS 18%W

ORDER NO.	L mm	H mm	K mm	KNIVES PER SET
792.400.30	400	30	3	2
792.997.30	1050	30	3	2

CMT's new selection of Planer & Jointer Knives are carefully ground from fine European high quality steel. You'll appreciate the high quality finish on these tools, and more importantly, you'll love their fine performance.

**MATERIAL**

Dry Softwood	●
Wet Softwood	○
Dry Hardwood	●
Wet Hardwood	●
Glulam	○

- Suitable
- Party suitable



Set of 2 Magnetic Knife Setting Jigs

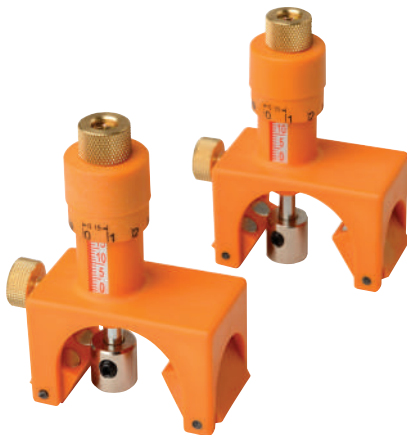

Insert your knives into the tool holders and align them perfectly with this set! Perfect micro adjustments on will guarantee excellent cutting performance!

1. MAGNETIC STOP
2. JOINTS WITH MAGNETIC CONNECTORS
3. LOCK SCREW



**CMT792**

**2 SETUP POSSIBILITIES**

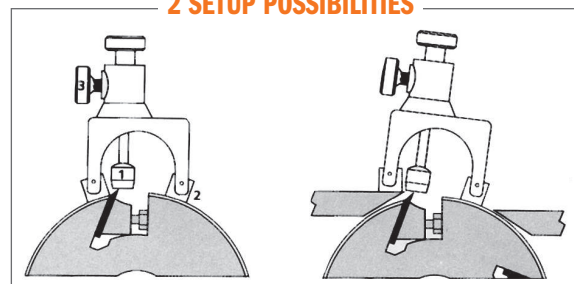

Positioning on the tool holder body with detection of the knife position.

Direct positioning on both the planer table and the tool holder body with detection of the knife position.

ORDER NO.	DESCRIPTION
CMT792  25	Set of 2 magnetic knife setting jigs

SOLID CARBIDE

## 790

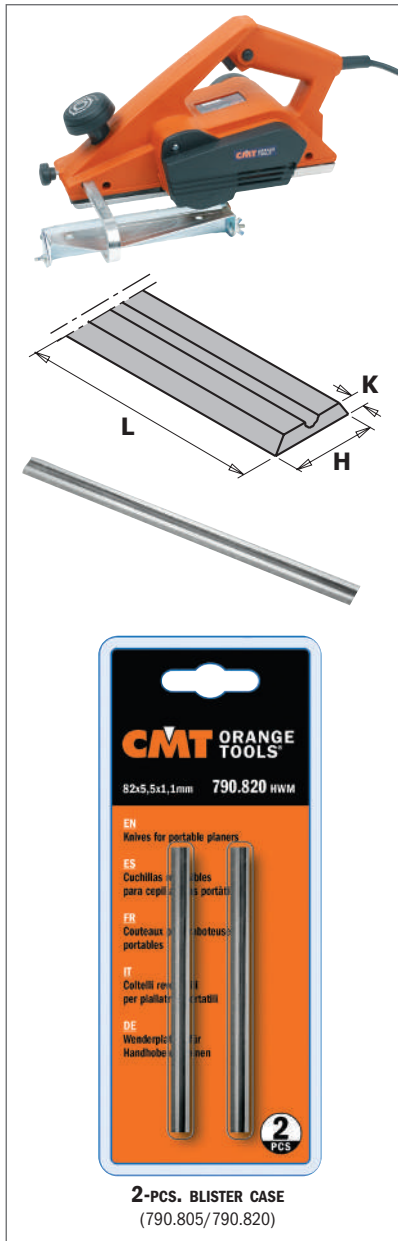

2-PCS. BLISTER CASE  
(790.805/790.820)

ORDER NO. 2-pcs. blister case	L mm	H mm	K mm	MACHINE	MODEL MACHINE
790.805	80.5 x 5.5 x 1.1			AEG®, BOSCH®	
				HAFFNER®	
				ELU®	MFF40, MFF80, MFF81, MFF81EK, PF161
790.820	82 x 5.5 x 1.1			AEG®	EH82, EH825, EH822, EH450, EH700, EH82-1, H500, H750, EH700R
				BLACK & DECKER®	DN76
				BOSCH®	PHO 100/150, PHO200/300 4387, PHO 2-82/3-82, GUSTAV, H00882
				CASALS®	CE82
				DEWALT®	DW678, DW678EK, DW680
				ELU®	HH15, HH40, HH40K, HH40EK
				FEIN®	HS2151
				FELISATTI®	TP282
				HAFFNER®	FH224
				HITACHI®	F20, F20A, FP20A, P20V, P20SA
				HOLZ-HER®	2321, 2322
				LEGNA®	R82, G82
				MAFELL®	EHU82, MHU82
				MAKITA®	1001, 1100, 1125B, 1900B, 1901, 1923B, 1923H, 1923HO
				METABO®	4382, 8382, 0882, 0883, E0983
				PERLES®	HHB82B
				PEUGEOT®	RA400, 82RAC, RA82CS, BR82 BRA1-82, BRA3-82, RA1082CA
				RYOBI®	L1323-A
				SKIL®	H92, H94, H95, H96, H97 1506, 1510
				STAYER®	980B



2-PCS. BLISTER CASE

ORDER NO. 2-pcs. HSS	ORDER NO. 2-pcs. TCT	L mm	H mm	K mm	MACHINE	MODEL MACHINE
790.821.50	790.821.10	82	x 29	3	BOSCH®	GH020-82
					BLACK & DECKER®	DN710, DB711
					MAKITA®	1900B, 1923B, 1100, 1901, 1125, KP0800K, KP0810, XPK01
790.110.50		110	x 29	3	RYOBI®	L-1323A, L-282
					MAKITA®	1002BA, 1911B
<b>TECHNICAL DETAILS:</b>					<b>APPLICATION:</b>	
- Order no. ISO: ..... K40					Softwood .....	Good
- Hardness (HV10):..... 1.400					Hardwood .....	Suitable
- Transverse rupture strength (N/mm²):..... 2.600					Plywood .....	Suitable

## 790



	L mm	H mm	K mm	TYPE	A	T	ORDER NO. K1920	ORDER NO. K2250
	7.5	12	1.5			35°	2	790.075.00
7.65	12	1.5			35°	2	790.076.00	
9.6	12	1.5			35°	2	790.096.00	
11.6	12	1.5			35°	2	Y790.116.00	
15	12	1.5			35°	2	790.150.00	
19.5	12	1.5			35°	4	790.195.12	
20	12	1.5			35°	2	790.200.00	790.200.03

	L mm	H mm	K mm	A	T	ORDER NO. K1920	ORDER NO. K2250
	24.7	12	1.5		35°	2	790.250.00
30	12	1.5		35°	2	790.300.00	790.300.03
40	12	1.5		35°	2	790.400.00	790.400.03
50	12	1.5		35°	2	790.500.00	790.500.03
60	12	1.5		35°	2	790.600.00	790.600.03

	L mm	H mm	K mm	TYPE	A	T	ORDER NO. K1920
	29.5	9	1.5			35°	4
29.5	12	1.5			35°	4	790.295.12
39.5	12	1.5			35°	4	790.395.12
49.2	9	1.5			35°	4	790.495.09
49.2	12	1.5			35°	4	790.495.12
58	12	1.5			35°	2	790.580.01

	L mm	H mm	K mm	A	T	ORDER NO. K1920
	28.3	12	1.5		35°	4
48.3	12	1.5		35°	4	790.483.12

	L mm	H mm	K mm	A	T	ORDER NO. K1920	ORDER NO. K2250
	10.5	10.5	1.5		35°	4	790.105.03
12	12	1.5		35°	4	790.120.00	790.120.03

	L mm	H mm	K mm	A	T	ORDER NO. K1920	ORDER NO. K2250
	13.6	13.6	2		30°	4	790.136.00
14	14	1.2		30°	4	790.140.10	
14	14	2		30°	4	790.140.00	790.140.03
14	14	2		45°	4	790.140.02	

	L mm	H mm	K mm	R mm	A	T	ORDER NO. K1920
	14	14	2	0.75	30°	4	790.140.20

	L mm	H mm	K mm	A	T	ORDER NO. K1920
	20	4.1	1.1		35°	4
30	5.5	1.1		35°	4	790.300.01
50	5.5	1.1		35°	4	790.500.01

## 790



	L mm	H mm	K mm	A	T	ORDER NO. F1640
	50	9	1.5	35°	4	790.500.09
	50	12	1.7	35°	4	790.503.00

	L mm	H mm	K mm	A	T	ORDER NO. F1640
	14.3	14.3	2.5	35°	4	S790.143.00

	L mm	H mm	K mm	R mm	A	T	ORDER NO. K1920
	15	15	2.5	150	30°	4	790.152.22

	L mm	H mm	K mm	R mm	A	T	ORDER NO. K1920
	15	15	2.5	100	30°	4	790.152.62

	L mm	H mm	K mm	R mm	A	T	ORDER NO. K1920
	19.5	9	1.5	2	35°	2	790.020.00
	19.5	9	1.5	3	35°	2	790.030.00
	19.5	9	1.5	5	35°	2	790.050.00
	24	12	1.5	6.4	35°	2	790.064.00
	24	12	1.5	8	35°	2	790.080.00

	L mm	H mm	K mm	A	T	ORDER NO. K1920
	28	14	2	30°	2	790.280.00

	L mm	H mm	K mm	A	T	ORDER NO. DP
	30	12	1.5	35°	1	790.300.60*

\*These knives are supplied in a 2 pc. case. Minimum 2 pieces or multiple of 2 piece order.

MATERIAL	K1920	K2250
Softwood	★★★★	
Hardwood	★★★★★	
Chipboard	★★★★★	★★★★★
MDF	★★★★	★★★★★
HDF	★★★★	★★★★★
Plastics	★★★	★★★★★
Solid Surface		★★★★

### TECHNICAL DETAILS:

**K1920** Hardness (HV10): 1.920 - Transverse rupture strength (N/mm<sup>2</sup>): 2.600  
New chrome grade for universal cutting applications. Excellent resistance to corrosion, oxidation and mechanical wear. High efficiency, 20% longer lifetime compared to standard grade.

**K2250** Hardness (HV10): 2.250 - Transverse rupture strength (N/mm<sup>2</sup>): 2.400  
New nano-grain grade for maximum wear resistance. Higher efficiency due to improved tool lifetime. Improved toughness.



All knives are supplied in a 10 pc. case.  
Minimum 10 piece or multiple of 10 piece order.





### 791 BEARINGS

ORDER NO.		D		B		T <sub>1</sub>
		inches	mm	inches	mm	mm
791.035.00	10	1/4	6.35	1/8	3.17	2.8
791.062.00*	10		9.3	3/16	4.76	3.17
791.002.00	10	3/8	9.52	3/16	4.76	3.2
791.063.00*	10		12.5	3/16	4.76	4.98
791.003.00	10	1/2	12.7	3/16	4.76	5
791.010.00	10	1/2	12.7	1/4	6.35	4.8
791.022.00	10		13		5	4
791.018.00	10	5/8	15.8	3/16	4.76	5
791.009.00	10	5/8	15.8	1/4	6.35	5
791.006.00	10		16		5	5
791.025.00	10		16		8	5
791.019.00	10	3/4	19	3/16	4.76	7.5
791.007.00	10		19		6	6
791.004.00	10	3/4	19	1/4	6.35	7
791.034.00	10		19		8	6
791.011.00	10	3/4	19	1/2	12.7	4
791.012.00	10		22		8	6
791.005.00	10		22		8	7
791.017.00	10	7/8	22.2	3/16	4.76	7.5
791.021.00	10	7/8	22.2	3/8	9.52	7
791.013.00	10	7/8	22.2	1/2	12.7	7
791.037.00	10		28		8	9
791.026.00	10		28		12	8
791.014.00	10	1-1/8	28.5	3/16	4.76	8.4
791.030.00	10	1-1/8	28.5		8	8.5
791.027.00	10	1-1/8	28.5	1/2	12.7	8
791.033.00	10	1-1/4	31.7		8	5
791.015.00	10	1-1/4	31.7	1/2	12.7	8
791.016.00	10	1-3/8	34.9	3/16	4.76	11.5
791.031.00	10	1-3/8	34.9		8	11.6
791.029.00	10	1-3/8	34.9	1/2	12.7	11
791.028.00	10		37		12	12
791.020.00	10	1-1/2	38.1	1/2	12.7	13.3
<b>10° DELRIN® Conical Bearings</b>						
791.041.00	10	3/4	19	3/16	4.76	6.8
791.048.00	10	22		3/16	4.76	6.8
<b>DELRIN® Triangular Bearings</b>						
791.042.00	10	1/2	12.7	3/16	4.76	5.8
791.043.00	10	3/4	19	3/16	4.76	6.8
<b>DELRIN® Cylindrical Bearings</b>						
791.044.00	10	1/2	12.7	3/16	4.76	5
791.045.00	10	5/8	15.8	3/16	4.76	7.2
791.046.00	10	3/4	19.05	3/16	4.76	6.8
791.047.00	10		37.4	1/2	12.7	15.7

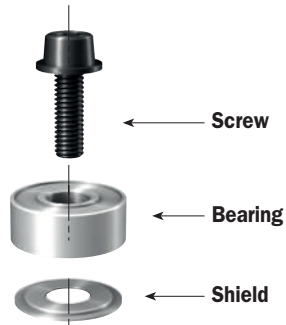
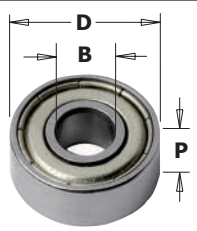

**SAFETY RECOMMENDATIONS:** be sure to keep the black washer right side up so that it corresponds with the bearing rotation during reassembly.

\* After resharpening, always switch to an undersized bearing:

791.062.00 Ø9.3 replaces 791.002.00 (Ø9.5)  
791.063.00 Ø12.5 replaces 791.003.00 (Ø12.7)

Sold in 10 pc. case.  
Minimum 10 pc. or multiple orders.



DELRIN® Cylindrical Bearings



10° DELRIN® Conical Bearings



DELRIN® Triangular Bearings

### 990 SHIELDS FOR BEARINGS

ORDER NO.		B		D	
		inches	mm	inches	mm
990.422.00	10	3/16	4.76	3/8	9.52
990.423.00	10	3/16	4.76	1/2	12.7
990.425.00	10	1/4	6.35	3/4	19
990.426.00	10	1/2	12.7	1-3/8	34.9

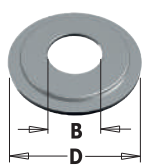

NEW  
NEW

### 799 REDUCTION BUSHING FOR BEARING

	ORDER NO.		D		B	
			inches	mm	inches	mm
	<b>799.019.00</b>	<b>10</b>	1/4	6.35	3/16	4.76
	<b>799.017.00</b>	<b>10</b>	5/16	7.94	3/16	4.76
<b>799.014.00</b>	<b>10</b>	1/2	12.7	3/16	4.76	

### 541 STOP COLLAR FOR TOP BEARING BITS

	ORDER NO.		B	
			inches	mm
	<b>541.001.00</b>	<b>10</b>	1/4	6.35
	<b>541.006.00</b>	<b>10</b>	3/8	9.52
<b>541.002.00</b>	<b>10</b>	1/2	12.7	

### 541 SHIELDS FOR ASSEMBLY

	ORDER NO.		B	D	P	ORDER NO.		B	D	P
			mm	mm	mm			mm	mm	mm
	<b>541.550.00</b>	<b>10</b>	3.25	9	1.6	<b>541.519.00</b>	<b>10</b>	8	14.7	5.8
	<b>541.552.00</b>	<b>10</b>	3.25	15.8	2	<b>541.526.00</b>	<b>10</b>	12	18	0.1
	<b>541.551.00</b>	<b>10</b>	5.2	15.8	2.5	<b>541.512.00</b>	<b>10</b>	12	20	2
	<b>541.514.00</b>	<b>10</b>	6.4	9.52	2.2	<b>541.511.00</b>	<b>10</b>	12	20	3
	<b>541.515.00</b>	<b>10</b>	8	14	0.1	<b>541.520.00</b>	<b>10</b>	12	21	0.3
	<b>541.516.00</b>	<b>10</b>	8	14	0.3	<b>541.521.00</b>	<b>10</b>	12	21	1.59
	<b>541.517.00</b>	<b>10</b>	8	14	0.5	<b>541.522.00</b>	<b>10</b>	12	21	3.18
	<b>541.518.00</b>	<b>10</b>	8	14	1	<b>541.523.00</b>	<b>10</b>	12	21	6.16
	<b>541.500.00</b>	<b>10</b>	8	14.7	3	<b>541.524.00</b>	<b>10</b>	12	21	1
	<b>541.501.00</b>	<b>10</b>	8	14.7	4	<b>541.525.00</b>	<b>10</b>	12	21	0.5

### 799 BUSHINGS

	ORDER NO.		D		B		L
			inches	mm	inches	mm	inches
	<b>799.064.00</b>	<b>10</b>	1/4	6.35	5/16	7.94	1
	<b>799.164.00</b>	<b>10</b>	1/4	6.35	3/8	9.52	1
	<b>799.264.00</b>	<b>10</b>	1/4	6.35	1/2	12.7	1
<b>799.001.00</b>	<b>10</b>	3/8	9.52	1/2	12.7	1	

### 991 KEYS FOR SCREWS

	ORDER NO.		DESCRIPTION	ORDER NO.		DESCRIPTION
	Hex Keys			TORX® Key		
	<b>991.057.00</b>	<b>10</b>	3/32" hex key for 1/8" screw	<b>991.063.00</b>	<b>10</b>	TORX® Key T8
	<b>991.056.00</b>	<b>10</b>	1.5mm hex key	<b>991.069.00</b>	<b>10</b>	TORX® Key T9
	<b>991.060.00</b>	<b>10</b>	2mm hex key	<b>991.061.00</b>	<b>10</b>	TORX® Key T15
	<b>991.062.00</b>	<b>10</b>	2.5mm hex key	<b>991.072.00</b>	<b>10</b>	TORX® Key T20
	<b>991.067.00</b>	<b>10</b>	3mm hex key	<b>991.073.00</b>	<b>10</b>	TORX® Key T25
	<b>991.064.00</b>	<b>10</b>	4mm hex key	<b>991.071.00</b>	<b>10</b>	TORX® Key T30

### 796



ORDER NO.		DESCRIPTION
<b>796.001.00</b>	<b>10</b>	Router collet extension with 1/2" collet
<b>796.001.01</b>	<b>10</b>	Router collet extension with 1/4" collet
<b>796.564.00</b>	<b>10</b>	Spare collet 1/4"
<b>796.627.00</b>	<b>10</b>	Spare collet 1/2"

**TECHNICAL DETAILS:**

- Super strength steel.
- Precisely machined for accuracy.

**Collet included.**

### 990 SCREW FOR BEARING

ORDER NO.	d x l x L mm	D mm	TYPE	ORDER NO.	d x l x L mm	D mm	TYPE
<b>990.008.00</b>	M5x8		<b>1</b>	<b>990.099.00</b>	M8x25x33	13	<b>7</b>
<b>990.003.00</b>	M5x10		<b>1</b>	<b>990.059.00</b>	1/8"x1/2"x5/8"	5.5	<b>7</b>
<b>990.060.00</b>	M2x2		<b>2</b>	<b>990.010.00</b>	M5x10x15	8.5	<b>7</b>
<b>990.016.00</b>	M4x4		<b>2</b>	<b>990.004.00</b>	M4x4x6	8	<b>8</b>
<b>990.091.00</b>	M4x20		<b>2</b>	<b>990.055.00</b>	M5x9x12	9.8	<b>8</b>
<b>990.015.00</b>	M5x4		<b>2</b>	<b>990.067.00</b>	M5x5x8	9	<b>8</b>
<b>990.001.00</b>	M5x5		<b>2</b>	<b>990.083.00</b>	M6x8x10	8.8	<b>8</b>
<b>990.006.00</b>	M5x5 w/cup point		<b>2</b>	<b>990.116.00</b>	M6x8.7x12	12	<b>8</b>
<b>990.005.00</b>	M3x3		<b>3</b>	<b>990.097.00</b>	1/4"-20x7/8"	12	<b>8</b>
<b>990.002.00</b>	M5x5		<b>3</b>	<b>990.058.00</b>	1/8"x3/8"x1/2"	7	<b>12</b>
<b>990.007.00</b>	M6x6		<b>3</b>	<b>TORX® Screw</b>			
<b>990.013.00</b>	M4x3		<b>3</b>	<b>990.088.00</b>	M5x11.5x17	8 T20	<b>6</b>
<b>990.014.00</b>	M4x4		<b>3</b>	<b>990.082.00</b>	M3x4x5.7	4.5 T8	<b>9</b>
<b>990.087.00</b>	M6x8		<b>4</b>	<b>990.070.00</b>	M2.5x3x4.5	3.5 T8	<b>10</b>
<b>990.066.00</b>	M6x16		<b>4</b>	<b>990.071.00</b>	M2.5x4.5x6	3.7 T8	<b>10</b>
<b>990.084.00</b>	M6x20		<b>4</b>	<b>990.079.00</b>	M4x2x3.2	6 T9	<b>10</b>
<b>990.085.00</b>	M6x25		<b>4</b>	<b>990.080.00</b>	M5x3.6x6.1	8.8 T25	<b>10</b>
<b>990.065.00</b>	M8x12		<b>4</b>	<b>990.093.00</b>	M5x5x8	9 T25	<b>10</b>
<b>990.064.00</b>	M8x16		<b>4</b>	<b>990.063.00</b>	M5x13x18	6.8 T15	<b>10</b>
<b>990.086.00</b>	M8x20		<b>4</b>	<b>990.072.00</b>	M3.5x3.5x6	6 T15	<b>11</b>
<b>990.068.00</b>	M5x5x9	6	<b>5</b>	<b>990.094.00</b>	M4x5.5x8	7.4 T20	<b>11</b>
<b>990.062.00</b>	M2.5x6x8.5	4.5	<b>7</b>	<b>990.073.00</b>	M3.5x5x7.2	9 T15	<b>11</b>
<b>990.051.00</b>	M3x6x9	5.5	<b>7</b>	<b>990.077.00</b>	M3.5x6x8.5	7 T15	<b>11</b>
<b>990.053.00</b>	M3x10x13	5.5	<b>7</b>	<b>990.074.00</b>	M4x3.5x5.7	9 T15	<b>11</b>
<b>990.054.00</b>	M3x16x19	5.5	<b>7</b>	<b>990.076.00</b>	M4x4x6.2	6 T15	<b>11</b>
<b>990.052.00</b>	M4x6x10	7	<b>7</b>	<b>990.056.00</b>	M4x4x6.2	8.8 T15	<b>11</b>
<b>990.061.00</b>	M4x12x16	7	<b>7</b>	<b>990.078.00</b>	M4x6x8	6 T15	<b>11</b>
<b>990.098.00</b>	M6x25x31	10	<b>7</b>	<b>990.075.00</b>	M4x6x8.2	9 T15	<b>11</b>

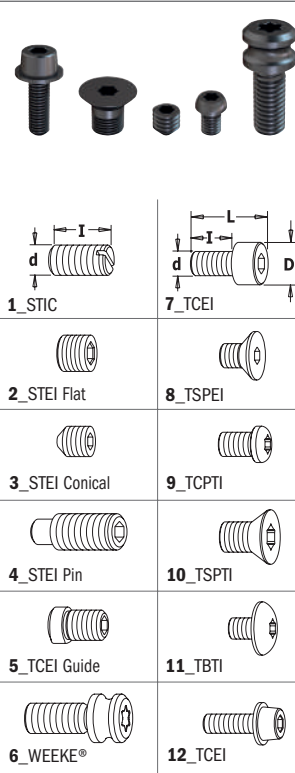

PACK QTY.  
10 pc

### 990.0 NUTS FOR ARBORS

ORDER NO.		DESCRIPTION
<b>990.020.00</b>	<b>10</b>	Nut for arbor M8 thread
<b>990.022.00</b>	<b>10</b>	Nut for arbor M12x1.25 thread

DESCRIPTION	PAGE
1-piece Rail & Stile Cutter Heads .....	334
12 Corner Radius Router Template Set from 1/8" to 1" .....	259
12-piece Router Bit Set .....	218
13-piece Dovetail & Straight Router Bit Set .....	216
13-piece Multiprofile Cutter Head Sets without Limiters .....	336
13-piece Router Bit Set .....	219
15-piece Router Bit Sets .....	217
16-piece Jig Saw Blade Set .....	107
2 Flute Dowel Drills .....	293-294
2 Flute Dowel Drills for Through Holes .....	299
2-piece Adjustable Grooving Sets .....	322
2-piece Adjustable Rounding & Chamfering Sets .....	323
25-piece Reciprocating Saw Blade Set .....	100
3-Flute Slot Cutter for STRIPLOX® Mini .....	208
3-in-1 Flush Trim Bits for MDF/Laminate .....	155
3-piece Adjustable Grooving Sets .....	321
3-piece Divided Light Door Set .....	234
3-piece Entry & Interior Door router Bit Set .....	233
3-piece Glass Panel Set .....	235
3-piece Junior Raised Panel Sets with Back Cutter .....	226
3-piece Kitchen Sets .....	222
3-piece Plywood Groove Sets .....	143
3-piece Raised Panel Sets with Back Cutter .....	227
3-piece Small Arch Door Set .....	228
3-piece Tongue & Groove Cabinetmaking Set .....	232
3-Wing Slot Cutter .....	166
3D Router Carver System .....	263-265
4 Flute Dowel Drills .....	295-297
4-Wing Cut Out Slot Cutters for Solid Surfaces .....	211
45° Chamfer Cutter Heads .....	324
45° Lock Miter Cutter Heads .....	329
5-piece Complete Kitchen Sets .....	221
5-piece Solid Carbide Spiral Bit Sets .....	143
6-piece Cabinetmaking Sets .....	223
6-piece Router Bit Set .....	220
60° Lettering Bit .....	177
7-piece Crown Molding Set .....	236
90° Solid Carbide Countersink with Parallel Shank .....	302
Accessories for Multi-Cutters .....	110-134
Adapters & Bushings for Twist Drills .....	298
Adaptors .....	289
Additional Templates, Bits & Accessories .....	253
Adjustable Chamfering CNC Cutter .....	286
Adjustable Corner Frame Clamps .....	257
Adjustable Countersink .....	302
Adjustable Double Roundover Router Bits .....	193
Adjustable Precision Router Dado Jig .....	255
Adjustable Roundover & Bevel Router Bits .....	193
Adjustable Shaker Router Bit Sets .....	230
Adjustable Tongue & Groove Bit Set for Mission Style Cabinet Doors .....	230
Adjustable Torque Screwdriver Set 1-6 Nm .....	267
Back-to-Back Connectors for Straight Edge Clamps (optional) .....	256
Ball End Bit .....	183
Bead & Bull Nose Bits .....	195
Beading Bits .....	187
Bench Block Set .....	259
Bi-Metal Plus Hole Saws .....	314-315
Biscuit Joiner .....	44
Blank Knives (To Be Sharpened) .....	349

DESCRIPTION	PAGE
BLUM® Hinge Boring Head .....	250
Boring Bits with Parallel Shank .....	302
Bowl & Tray Bits .....	177
Bowl & Tray System .....	262
Box & Finger Joint Set .....	40
Building Arched Raised Panel Doors .....	224-225
Bull Nose Bit .....	244
Cabinetmaker's .....	23
Calibration & Sanding Disks .....	44
Carpenter Pencil & Ink Pen .....	266
Cavetto Edge Mould Bits .....	185
Chamfer Bit .....	242
Chamfer Bits .....	181
Chamfer Bits with Insert Knives .....	180
Chamfer Set .....	181
Chipboard & Melamine .....	75
Classical Bead Bits .....	188
Classical Ogee Bit .....	247
Classical Ogee Bits .....	191
Clearing grass, bushes, small trees .....	69
CMT Contractor Sets .....	248
CMT Moulding System .....	196
CMT Professional Tool Bag .....	267
CMT's Limited Warranty and Procedures .....	368
Combination .....	18-19, 54, 72
Combination Trimmer Bits .....	151
Construction/Demolition/Rescue .....	69
Contour Duplicator Gauge .....	257
Conversion Table .....	363
Convex Edge Bit .....	244
Corner Bead Bit .....	245
Corner Beading Bits .....	195
Cove & Fillet Bits .....	243
Cove Bit Set .....	184
Cove Bits .....	184, 243
Cutter Heads without Limiters .....	335
Dado & Planer Bits .....	147
Dado Pro .....	41
Decorative Beading Bits .....	189
Decorative Ogee Bit .....	245
Decorative Ogee Bits .....	189-190
Demolition .....	46
Diamond Compression Bits .....	282
Diamond Dry Hole Saws .....	316-317
Diamond for Fiber Cement Products .....	61
Digital Angle Finder .....	260
Digital Angle Gauge .....	260
Digital Height Gauge .....	261
Digital Moisture Meter .....	261
DLCS Chrome Coating Solid Carbide Upcut & Downcut Spiral Bits .....	141, 276
Door Lip Bit & Finger Grip Bit .....	198
Double-Bearing Spiral Flush Trim Bits .....	155
Double-Edge Trimmer .....	268
Double-Sided - Laminate & Melamine .....	31
Dovetail Bits .....	174-175, 241
Dowel Drills .....	292
Dowel Drills for Through Holes .....	290
Dowel Drills with Countersink .....	294
DP - Flush Trim Bits for Laminates .....	152







# Alphabetical Index

DESCRIPTION	PAGE
Drawer Lock Bits.....	171
Edge Banding Bits Set .....	176
Edge Banding End Trimmer.....	268
Edge-Fluting Bits.....	196
Explanation of Symbols.....	366
Fast Framing.....	62
Fiber Cement Products.....	60
<b>FILE-FREE</b> Flush Trim Bits for Laminate .....	152
Fine Finish .....	20-21, 55, 87
Fine Finish Compound Sliding.....	56
Fine Finish Sliding Compound.....	24
Finger Joint Bit.....	167
Finger Pull Bit .....	200
Finish.....	48, 64, 73, 81, 86
Finish for Plywood .....	67, 83
Finish Sliding Compound .....	74
Flexible Template for Curved & Arched Routing.....	254
Flooring Router Bits .....	163
Flush Trim Bit Set .....	154
Flush Trim Bits.....	153, 240
Flush Trim Bits with Insert Knives.....	156
Flush Trim Router Bits with Double Bearing .....	157
Flute & Bead Set .....	168
<b>FORMULA 2050</b> Blade & Bit Cleaner .....	258
Forstner Bit Sets.....	304
Forstner Bits.....	304
Framing.....	47
Framing & Ripping .....	52
Framing/Decking.....	80
General Purpose.....	17, 53, 71, 85
General Purpose Set for Multi-Cutters.....	134
Grand Rabbeting Bits with Insert Knives .....	161
Guide to choosing the most suitable jig saw blade.....	102
Heavy-Duty Fine Finish.....	22
Heavy-Duty General Purpose.....	16
Heavy-Duty Glue Line Ripping .....	15
Heavy-Duty Solid Surface & Composite Decking.....	39
Hinge Boring Bits.....	300
Hinge Boring System.....	249
Hole Saw Adaptors .....	311
Hole Saw Arbors, Pilot Drills & Kit.....	310
HSK Chuck for Grooving Blade.....	274
HSK-63F Chuck for "ER32" Precision Collets .....	271
HSK-63F Chucks for "EOC25" Precision Collet "DIN6388".....	271
HSK-63F Chucks for "ER40" Precision Collets .....	271
INDUSTRIAL Panel Sizing.....	33
INDUSTRIAL Scoring.....	32
Inlay Kit.....	250
Interchangeable Torque Wrench 20~200 Nm .....	266
ISO30 Chucks for "ER32" Precision Collets .....	272
ISO30 Chucks for "ER40" Precision Collets .....	272
Jig Saw Blades.....	103~107
Junior Ogee Rail & Stile Set.....	204
Keyhole Bit .....	241

DESCRIPTION	PAGE
Keyhole Bits.....	162
Kinetic Dust Extractor.....	270
Laminate Trimmer Bits.....	240
Laminate/Veneer Cutter .....	268
Laser Point Bit .....	179
Latex Coated Gloves .....	268
Lock Miter Bits .....	169
Lock Miter Set .....	168
LOCKED Dado Pro.....	43
Maximize Your Saw's Performance.....	5
Maximizing Boring Performance.....	288
MEDIUM/THICK - Metal & Steel (1/16"~ 1/2").....	37
Melamine & Ultra Finish .....	76
Metal & Stainless Steel .....	50
Mortise Chisel & Bit Sets .....	303
Mortising Bits .....	146, 239
Moulding Bits .....	197-198
Multi-Materials Carbide Wheel.....	68, 318
Multi-Purpose Hole Saws .....	312-313
Multi-Rip with Rakers.....	14
Multiprofile Bits.....	199
Multiradius Roundover Cutter Heads.....	325-326
Non-Blocking Combination Trimmer Bit .....	152
Non-Ferrous & Laminate.....	58
Non-Ferrous Metal & Composite Decking.....	77
Ogee Bit .....	246
Ogee Bits.....	192
Ogee with Fillet Bit .....	246
Ogee with Fillet Bits.....	192
One-Piece Rail & Stile Bit .....	203
Organizers .....	258
Ovolo Bit.....	244
Ovolo Bits .....	185
Ovolo Sash Bits .....	172
Ovolo Sash Set .....	172
Pair of Bore Reducers.....	335
Panel Pilot Bits .....	240
Panel Pilot Bits with Guide.....	158
Pattern Bits.....	148, 239
Pattern Router Bits with Insert Knives .....	149
Pattern Router Bits with Insert Knives for Laminates.....	149
Pattern/Flush Trim Bits with Insert Knives.....	157
Planer & Jointer Knives.....	350
Plastic .....	40
Plug Cutters.....	303
Plunge Ogee Bit.....	245
Plunge Ogee Bits .....	190
Pocket-Pro Joinery System .....	251
Precision Collets "DIN6388" .....	273
Precision Collets "DIN6499".....	273
Precision Dado .....	42
Professional Finger Joint Bit.....	167
Professional Finger Joint Cutter Heads.....	330
Professional Raised Panel Cutter Heads.....	331
Professional Straight Edge Clamps.....	256
Profile & Counter Profile Cutter Head Sets .....	332-333

# Alphabetical Index

DESCRIPTION	PAGE
Profile Knives for Insert Shaper System.....	337~349
Rabbeting Bits.....	161, 241
Rabbeting Bits with Insert Knives.....	159
Rabbeting Cutter Heads.....	320
Rabbeting Sets.....	159
Rail & Stile Set.....	204
Rail & Stile Sets.....	202
Raised Panel Bit with Back Cutter.....	206
Raised Panel Bits.....	205
Reciprocating Saw Blades.....	92~100
Reciprocating Saw Blades Application Chart.....	90-91
Reduction Rings for Saw Blades.....	44
Replacement Bearing Set.....	247
Reverse Glue Joint Bits.....	170
Reverse Glue Joint Cutter Heads.....	328
Ripping.....	12-13, 70, 84
Roman Ogee Bits.....	191, 246
Rosette Cutters.....	305
Round Nose Bits.....	182, 242
Round Nose Set.....	183
Roundover & Beading Bits.....	243
Roundover & Cove Cutter Heads.....	327
Roundover Bits.....	186
Roundover Bits with Insert Knives.....	188
Roundover Set.....	187
Router Bits for DOMINO® Joining Machines by <b>FESTOOL®</b> .....	305
Routing Guide.....	138~140
Safety Recommendations.....	364
Saw Blades Stabilizers.....	44
Screw Slot Bits.....	163
Set of 2 Magnetic Knife Setting Jigs.....	350
Single-Sided - Laminata & Melamine.....	30
Slot Cutter Set.....	229
Slot Cutters.....	164-165
Solid Carbide Combination Trimmer Bits.....	150
Solid Carbide Dowel Drills.....	291
Solid Carbide Dowel Drills for Through Holes.....	290
Solid Carbide Downcut 2-Edge Spiral Bits.....	142
Solid Carbide Downcut Spiral Bits.....	278, 280
Solid Carbide Downcut Spiral Bits with Chip-Breaker.....	279
Solid Carbide Insert Knives.....	352-353
Solid Carbide Reversible Knives for Portable Planers.....	351
Solid Carbide Spiral Bits.....	277
Solid Carbide Twist Drills.....	298
Solid Carbide Upcut & Downcut Spiral Bits.....	141, 276
Solid Carbide Upcut 2-Edge Spiral Bits.....	142
Solid Carbide Upcut 2D/3D Carving Tapered Ball Nose Spiral Bits.....	277
Solid Carbide Upcut Ball Nose Spiral Bits.....	183
Solid Carbide Upcut Spiral Bits.....	278
Solid Carbide Upcut Spiral Bits with Chip-Breaker.....	279
Solid Surface - Bevel Bit.....	212
Solid Surface - Bevel Bowl Bits.....	211
Solid Surface - Counter-Top Trim Router Bits.....	208
Solid Surface - Cut & Plug Repair Set.....	212
Solid Surface - Decorative Edge Profile Bits.....	209
Solid Surface - Drainboard Bits.....	214
Solid Surface - Inlay Bits.....	214
Solid Surface - No-Drip Bit.....	213
Solid Surface - Rounding Over Bits.....	209

DESCRIPTION	PAGE
Solid Surface - Rounding Over Bowl Bit (ogee profile).....	210
Solid Surface - Rounding Over Bowl Bits.....	210
Solid Surface - Sink & Trim Bits.....	215
Solid Surface - Sink & Trim Bits with Insert Knives.....	215
Solid Surface - Wavy Joint Bit.....	213
Solid Surface and Fiberglass Bit with DLCs Chrome Coating.....	281
Spare Parts & Accessories.....	354~356
Spoilboard Surfacing Router Cutters.....	283
Spoilboard Surfacing Router Cutters with Insert Knives.....	283
Stainless Steel.....	38
Stile & Panel Router Bits.....	207
Straight Bit Short Series.....	144
Straight Bits.....	239
Straight Bits for Industrial Nesting Application DLCs Chrome Coating.....	280
Straight Bits, Long Series.....	145
Straight Router Cutters with Insert Knives.....	282
Super-duty Flush Trim Bit - XTREME Series.....	154
T-Slot Bits.....	162
Table Edge & Hand Rail Bits.....	201
Template Guide Kit.....	259
Tenon Cutting Router Bits.....	231
The CMT Grand Rabbet Set.....	160
THICK Non-Ferrous Metal (>1/8") & Melamine.....	35
THIN - Metal & Steel (Less than 3/32").....	36
THIN Non-Ferrous Metal (<1/8") & Plastics.....	34
Tongue & Groove Set.....	166
Toolcase for XTREME FAST Hole Saws.....	318
Ultimate Fast Framing V-DRIVE.....	63
Ultimate Finish V-DRIVE.....	65
Ultra Finish.....	26, 57, 66, 82
Ultra Finish - Plywood & Melamine.....	28-29
Ultra Finish Sliding Compound.....	25, 27
Universal Assembly Supports for Chucks.....	271
Universal Dovetail Jig.....	252
Universal Profile Cutter for CNC Machines.....	285
Using your Crown Molding Set.....	237
V-Groove - Folding - Signmaking CNC Router Cutters with Insert Knives.....	285
V-Grooving & Signmaking Router Bits with indexable knives (90°).....	180
V-Grooving Bits.....	179, 242
V-Grooving Bits (90°).....	178
V-Tongue & Groove Set.....	176
Vertical Raised Panel Bits.....	201
Vinyl Siding/PVC Piping/Plastic Gutters.....	68
Wainscot/Paneling Bits.....	194
Weatherseal Bits.....	150
What parameters should be considered when routing?.....	365
Window Sash Set.....	173
Window Sill & Finger Bits.....	200
Wood & Metal.....	51
XTREME FAST & FASTX4 Compatibility (New & Previous System).....	309
XTREME Plunge CNC Cutters with Insert Knives.....	284
XTREME Spoilboard Surfacing Router Cutter with Insert Knives.....	284





# Numerical Index



ORDER NO.	PAGE	ORDER NO.	PAGE	ORDER NO.	PAGE	ORDER NO.	PAGE
03.51	258	253	56	366	299	663.301	285
140	282	254	58	369	300	663.5	284
151	281	255	57	372	297	665	180
152	277	256	54	373	297	690	349, 337-349
178	283	257	51	376	294	692	335-336
183	271	271	62	377	294	694.001	321
183.200	272	272	64	380	305	694.002	324
183.201	272	274	25	392	302	694.003	326
183.250	272	276	77	521	302	694.004	325
183.300	271	279	14	521.001	302	694.005	323
183.310	271	281	33	529	303	694.007	327
183.320	271	281.6	22, 30-31	531	305	694.008	330
183.420	274	282	33	537	304	694.009	328
183.421	274	283.6	28	537.000.04	304	694.011	329
183.422	274	284	34	537.000.05	304	694.013	331
184	273	285	12, 16, 20, 26	537.000.07	304	694.014	334
185	273	285.6	18, 24	537.000.12	304	694.015	332-333
190	141, 276	286	46, 68-69, 318	537.000.16	304	694.021	322
190.41	141, 276	288	32	541	355	694.022	322
190B	155	289	32	543	303	694.100	320
191	142, 278	290	17	550-PA01	311	699	335
191.000.02	143	291	17	550-PA02	311	790	351-353
191B	155	292	21, 29	550-PA03	311	791	354
192	142, 278	293	13	550-PA05	311	791.703.00	159
192.000.02	143	294	21, 29	550-PA06	310	79101	247
192.41	280	296	35	550-PA07	311	792	350
192B	155	297	35	550-PA07	317	794	350
195	279	298	69	550-PD01	310	796	356
196	279	299	44, 322	550-PD02	310	799	355
198	277	299.10	44	550-PH11	310	799.517.00	160
199	183	299.11	44	550-PH85	310	800.001.00	217
201	13	306	296	550X	312-313	800.503.11	218
203	15	307	296	551X	314-315	800.504.11	220
205	21	308	295	552	316	800.505.11	219
210	29	309	295	552-0	316	800.506	166
213	17	310	293	552-001-05	316	800.509.11	221
215	19	310.21/22	291	552-7	317	800.510.11	221
219	27	310.41/42	292	552-701-06	317	800.511.11	221
221	23	311	294	552-EX16	317	800.512.11	222
222	40	311.21/22	291	552-GUIDE	317	800.512.11	222
223	39	311.41/42	292	552-WAX	316	800.513.11	222
225	35	313	299	652B	149	800.514.11	222
226	36-38	313.41/42	290	653	282, 284	800.515.11	223
226	50	314	299	656	149	800.516.11	222
230.012	41	314.21/22	290	657	156	800.517.11	227
230.224	40	314.41/42	290	657.1	156	800.518.11	226
230.312	43	317	300	657B	157	800.519.11	216
230.5	42	360.001	288	659	180	800.520.11	223
236	61	360.101	289	660	159	800.521.11	227
240	44	360.201	289	660.9	161	800.522.11	226
241	44	360.301	289	661.41	188	800.523.11	236-237
250	47, 52	360.401	289	663	283	800.524.11	228
251	48, 53	362	293	663.1	285	800.525.11	234
252	55	363	298	663.201	286	800.526.11	232
		364	298			800.527.11	233

# Numerical Index



ORDER NO.	PAGE	ORDER NO.	PAGE	ORDER NO.	PAGE	ORDER NO.	PAGE
800.606	167	836.501.11	181	860	192	CFC-002	257
800.616	167	837	184, 243	861	195, 245	CMT-TGA	259
800.622	193	837.001.11	184	861.6	194	CMT300	252-253
800.623	193	837.501.11	184	862	196	CMT333-03	249
800.624	230	838	186, 209, 243	863	185	CMT334	250
800.625	230	838.001.11	187	863	243	CMT792	350
800.626	166	838.501.11	187	864	185	DAF-001	260
800.627	231	839	187	865	189, 245	DAG-001	260
800.628	231	840	191, 246	865.1	190	DET-001	268
80004	248	841	191, 247	865.9	189	DET-002	268
80005	248	842	150, 240	865B	188	DET-003	268
801	146, 239	843	150, 240	866.501	211	DHG-001	261
801B	146	844	191, 247	866.6	210	DMM-001	261
806	152-153, 240	845	191	867.5B	198	GLA	268
806.001.11	154	846	192, 246	867.6B	198	JS025	100
806B	154, 157	847	192	867.701	197	JS1025VF	97
807	152, 155	848	190, 245	868	183	JS1110VF	94
809	151-152	848B	190	870	207	JS1111DF	93
811	144, 239	849	177	880.5	209	JS1111K	92
811.001.11	143	849B	177	880.511	214	JS1120CF	97
811.501.11	143	850	241	880.512	214	JS1122AF	99
811B	148	850.0	162	880.513	214	JS1122BF	98
812	145, 280	850.5	162	880.521	209	JS1122EF	98
812.032	150	850.6	162	880.531	213	JS1122HF	95
812B	148	851	177	880.541	210	JS1122VF	95
813	163	851B	177	880.542	210	JS1125VF	97
813.001	150	852	147	880.551	211	JS1141HM	99
814	182, 242	852B	147	880.56	215	JS1155CHM	96
814.001.11	183	853	158	880.57	215	JS1156XHM	96
814.501.11	183	854	195, 244	881.501	213	JS1210VF	94
814B	182	855	168, 171, 200	881.511	214	JS1211K	100
815	178-179, 242	855.3	172	881.512	214	JS1222VF	95
815B	178	855.501	170	881.521	212	JS1225VF	98
816	158, 240	855.503	169	881.531	213	JS123XF	97
816.064	158	855.504	169	881.541	212	JS1241HM	99
818	174-175, 241	855.506	176	890	205	JS1243HM	100
818B	174-175	855.510	176	890.5	206	JS1411DF	93
821	151	855.604-606	198	890.6	201	JS1531L	92
822	164	855.701	168	891.5	202	JS1617K	92
822.023B	163	855.8	200	891.512	204	JS2243HM	100
822.024B	163	855.801	173	891.517	204	JS2345X	92
822.033B	211	855.802	172	891.521	203	JS3456XF	94
822.034	208	855.803.11	235	899	250	JS5678XF	94
822A/B	164	855.8B	200	990	354, 356	JS610VF	93
823	165	855.901	197	990.0	356	JS611DF	93
823.001.11	229	855.902	197	990.088	289	JS617K	92
823.371	208	856.501	197	991	355	JS641HM	99
823B	165	856.601	201	992	270	JS644D	92
824	165	856.701	201	998	258	JS711DF	93
824.xxx.00	164	856.702	201	BAG-001	267	JS725VFR	94
824.xxx.10	164	856.8	199	BBS-001	259	JS920CF	96
827	185, 244	856.851	196	BTS-001	262	JS922AF	99
835	159, 161, 241	856.852	196	CDG-001	257	JS922BF	98
835.503.11	160	857	181				
835.990	160	858	179, 242				
836	181, 242	859	192, 246				





# Numerical Index

ORDER NO.	PAGE	ORDER NO.	PAGE	ORDER NO.	PAGE	ORDER NO.	PAGE
JS922EF	98	OMA30	124	OMM14	129	P07024	62
JS922HF	95	OMA30000	124	OMM15	130	P07040	64
JS922VF	95	OMA31	125	OMM16	130	P07056N	77
JS925VF	97			OMM17	130	P07060	66
JS955CHM	96	OMF-X4	123	OMM18	130	P07120-X10	68
JS956XHM	96	OMF001	121	OMM19	131	P07140-X10	67
		OMF002	121	OMM20	131	P075	63, 65
JT016	107	OMF106	113	OMM21	131	P08024	62
JT101A0	104	OMF113	113	OMM22	131	P08040	64
JT101B	104	OMF114	120	OMM23	132	P08060S	74
JT101BIF	105	OMF118	120	OMM24	132	P10024	70
JT101BR	104	OMF125	120	OMM25	133	P10042	71
JT101D	105	OMF126	114	OMM26	132	P10042W	71
JT111C	103	OMF133	114	OMM27	132	P10050	72
JT118A	106	OMF136	124	OMM28	133	P10060	73
JT118B	106	OMF157	119	OMM29	133	P10060L	75
JT119B0	103	OMF160	117	OMM30	133	P10060S	74
JT123X	106	OMF161	118	OMM35	129	P10080	76
JT127D	106	OMF165	122	OMM36	127	P10080N	77
JT141HM	107	OMF174	113			P12042	71
JT144D	103	OMF183	117	OMS01	126	P12072	73
JT150RF	107	OMF184	116	OMS02	126	P12072L	75
JT218A	106	OMF201	123	OMS03	126	P12072S	74
JT234X	105	OMF205	115	OMS04	126	P12096	76
JT244D	103	OMF208	116	OMS05	127	P12096N	77
JT244DDC	103	OMF221	117	OMS06	127	PCL-1	266
JT301CD	105	OMF222	118	OMS07	127	PCL-2	266
JT313AW	107	OMF223	119	OMS08	128	PGC	256
JT318VF	105	OMF226	122	OMS09	128	PGD-1	255
JT341HM	107	OMF228	118	OMS10	128	PPJ-002	251
JT344D	104	OMF229	116	OMS11	128		
JT718BF	106	OMF230	115	OMS12	129	RCS	263~265
JT744D	104	OMF232	115	OMS13	129		
		OMF233	114	OMS14	129	TMP	254
K02403	82	OMF237	119	OMS15	130	TMP-R12	259
K02405	81	OMF243	121	OMS16	130	TW-006	267
K02406	80	OMF245	122	OMS17	130	TW-200	266
K02407	80	OMF251	123	OMS18	130		
K02408	80			OMS19	131		
K02410	84	OMM-X16	134	OMS20	131		
K02412	84	OMM-X33	134	OMS21	131		
K03604	82	OMM-X37	134	OMS22	131		
K03606	81	OMM-X4	134	OMS23	132		
K04007	81	OMM01	126	OMS24	132		
K04008	81	OMM02	126	OMS27	132		
K04010	85	OMM03	126	OMS29	133		
K04012	85	OMM04	126	OMS30	133		
K06007	82	OMM05	127	OMS35	129		
K06010	86	OMM06	127	OMS36	127		
K06012	86	OMM07	127				
K06014	85	OMM08	128	P05018	62		
K08010	87	OMM09	128	P06018	62		
K08012	87	OMM10	128	P06036	64		
K14007-X10	83	OMM11	128	P06060	66		
K20010	83	OMM12	129	P065	63, 65		
		OMM13	129	P07010	60		

# Conversion Table



INCH DECIMALS	INCH FRACTIONS (X)						MILLIMETERS					
	1/64	1/32	1/16	1/8	1/4	1/2	mm	1" + (x)	2" + (x)	3" + (x)	4" + (x)	5" + (x)
								25.400	50.800	76.200	101.600	127.000
0.015625	1/64						0.397	25.797	51.197	76.597	101.997	127.397
0.031250		1/32					0.794	26.194	51.595	76.994	102.394	127.794
0.046875	3/64						1.191	26.591	51.991	77.391	102.791	128.191
0.062500			1/16				1.588	26.988	52.388	77.788	103.188	128.588
0.078125	5/64						1.984	27.384	52.784	78.184	103.584	128.984
0.093750		3/32					2.381	27.781	53.181	78.581	103.981	129.381
0.109375	7/64						2.778	28.178	53.578	78.978	104.378	129.778
0.125000				1/8			3.175	28.575	53.975	79.375	104.775	130.175
0.140625	9/64						3.572	28.972	54.372	79.772	105.172	130.572
0.156250		5/32					3.969	29.369	54.769	80.169	105.569	130.969
0.171875	11/64						4.366	29.766	55.166	80.566	105.966	131.366
0.187500			3/16				4.762	30.162	55.562	80.962	106.362	131.762
0.203125	13/64						5.159	30.559	55.959	81.359	106.759	132.159
0.218750		7/32					5.556	30.956	56.356	81.756	107.156	132.556
0.234375	15/64						5.953	31.353	56.753	82.153	107.553	132.953
0.250000					1/4		6.350	31.750	57.150	82.550	107.950	133.350
0.265625	17/64						6.747	32.147	57.547	82.947	108.347	133.747
0.281250		9/32					7.144	32.544	57.944	83.344	108.744	134.144
0.296875	19/64						7.541	32.941	58.341	83.741	109.141	134.541
0.312500			5/16				7.938	33.338	58.738	84.138	109.538	134.938
0.328125	21/64						8.334	33.734	59.134	84.534	109.934	135.334
0.343750		11/32					8.731	34.131	59.531	84.931	110.331	135.731
0.359375	23/64						9.128	34.528	59.928	85.328	110.728	136.128
0.375000				3/8			9.526	34.925	60.325	85.725	111.125	136.525
0.390625	25/64						9.922	35.322	60.722	86.122	111.522	136.922
0.406250		13/32					10.319	35.719	61.119	86.519	111.919	137.319
0.421875	27/64						10.716	36.116	61.516	86.916	112.316	137.716
0.437500			7/16				11.112	36.512	61.912	87.312	112.712	138.112
0.453125	29/64						11.509	36.909	62.309	87.709	113.109	138.509
0.468750		15/32					11.906	37.306	62.706	88.106	113.506	138.906
0.484375	31/64						12.303	37.703	63.103	88.503	113.903	139.303
0.500000					1/2		12.700	38.100	63.500	88.900	114.300	139.700
0.515625	33/64						13.097	38.497	63.897	89.297	114.697	140.097
0.531250		17/32					13.494	38.894	64.294	89.694	115.094	140.494
0.546875	35/64						13.891	39.291	64.691	90.091	115.491	140.891
0.562500			9/16				14.288	39.688	65.088	90.488	115.888	141.288
0.578125	37/64						14.684	40.084	65.484	90.884	116.284	141.684
0.593750		19/32					15.081	40.481	65.881	91.281	116.681	142.081
0.609375	39/64						15.478	40.878	66.278	91.678	117.078	142.478
0.625000				5/8			15.875	41.275	66.675	92.075	117.475	142.875
0.640625	41/64						16.272	41.672	67.072	92.472	117.872	143.272
0.656250		21/32					16.669	42.069	67.469	92.869	118.269	143.669
0.671875	43/64						17.066	42.466	67.866	93.266	118.666	144.066
0.687500			11/16				17.462	42.862	68.262	93.662	119.062	144.462
0.703125	45/64						17.859	43.259	68.659	94.059	119.459	144.859
0.718750		23/32					18.256	43.656	69.056	94.456	119.856	145.256
0.734375	47/64						18.653	44.053	69.453	94.855	120.253	145.653
0.750000					3/4		19.050	44.450	69.850	95.250	120.650	146.050
0.765625	49/64						19.447	44.847	70.247	95.647	121.047	146.447
0.781250		25/32					19.844	45.244	70.644	96.044	121.444	146.844
0.796875	51/64						20.241	45.641	71.041	96.441	121.841	147.241
0.812500			13/16				20.638	46.038	71.438	96.838	122.238	147.638
0.828125	53/64						21.034	46.434	71.834	97.234	122.634	148.034
0.843750		27/32					21.431	46.831	72.231	97.631	123.031	148.431
0.859375	55/64						21.828	47.228	72.628	98.028	123.428	148.828
0.875000				7/8			22.225	47.625	73.025	98.425	123.825	149.225
0.890625	57/64						22.622	48.022	73.422	98.822	124.222	149.622
0.906250		29/32					23.019	48.419	73.819	99.219	124.619	150.019
0.921875	59/64						23.416	48.816	74.216	99.616	125.016	150.416
0.937500			15/16				23.812	49.212	74.612	100.012	125.412	150.812
0.953125	61/64						24.209	49.609	75.009	101.409	126.809	152.209
0.968750		31/32					24.606	50.000	75.406	100.806	126.206	151.606
0.984375	63/64						25.003	50.403	75.803	101.203	126.603	152.003

# Safety Recommendations

## SAW BLADE SAFETY

- ALWAYS** thoroughly check all blades for damage and flaws before using. Do not use blades with missing or damaged teeth.
- ALWAYS** wear safety glasses and ear protection when using power tools.
- ALWAYS** thoroughly read the owners manual and manufacturer's instructions before working with tools.
- ALWAYS** use a fence and splitter when using the table saw. Do not make freehand cuts.
- ALWAYS** use pusher blocks or a pusher stick, especially when working with small or narrow pieces.
- ALWAYS** unplug your saw before cleaning or adjusting the tool, or before making blade changes.
- ALWAYS** keep your tools sharpened, clean and stored in a safe place to avoid breakage and accidents and to extend the life of your bits and blades.

- ALWAYS** feed the work against the rotation of the blade on table saws.
- ALWAYS** be sure your workpiece is completely supported, before and after the cut.
- NEVER** remove guards from radial arm saws and miter saws.
- NEVER** remove the splitter or anti-kickback devices from table saws.
- NEVER** use dull or damaged blades.
- NEVER** use blades with missing or chipped teeth.
- NEVER** force the cut or overload the saw.
- NEVER** change blades with the saw plugged in.
- NEVER** make adjustments to any saw while the blade is turning.

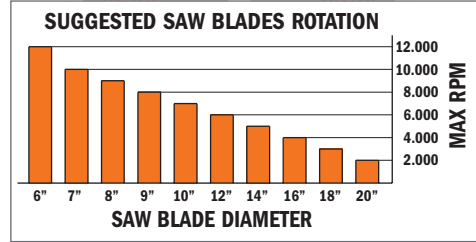

## ROUTER BITS SAFETY

- ALWAYS** thoroughly check all tools for possible flaws before using.
- ALWAYS** wear safety glasses and ear protection.
- ALWAYS** thoroughly read the owners manual and manufacturer instructions before using.
- ALWAYS** check that at least 75% of the shank is securely inserted into the collet of the router.
- ALWAYS** use template guide collars when possible to absorb lateral bit deflection.
- ALWAYS** use a fence when working on the router table.
- ALWAYS** reduce the router speed when working with larger diameter bits.
- ALWAYS** keep your fence adjusted so there is some clearance between the bearing guide and the workpiece.
- ALWAYS** take care to remove large quantities of stock (cross section > 3/8") in more than one run.

- ALWAYS** keep your tools sharpened, clean and stored in a safe place to avoid breakage and accidents and to extend the life of your bits and blades.
- NEVER** use dull or defective, even suspiciously defective, tools.
- NEVER** force the shank entirely into the collet (bottoming out). Leave about a 1/8" space from the bottom.
- NEVER** force the bit into your router or overload the router.

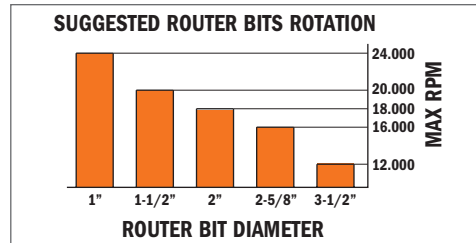

## CUTTER HEAD SAFETY

- ALWAYS** thoroughly check all cutters for damage and flaws before using.
- ALWAYS** wear safety glasses and ear protection when using power tools.
- ALWAYS** thoroughly read the owners manual and manufacturer's instructions before working with tools.
- ALWAYS** use guards that were supplied with your shaper.
- ALWAYS** use a fence with your shaper. Do not make freehand cuts.
- ALWAYS** use pusher blocks, especially when working with small or narrow pieces.
- ALWAYS** unplug your shaper before cleaning or adjusting the tool, or before making cutter or knife changes.
- ALWAYS** be sure the spindle nut is tight before plugging in the shaper.
- ALWAYS** check that knives are properly and securely installed in the cutterhead when using interchangeable-knife systems.
- ALWAYS** keep your tools sharpened, clean and stored in a safe place to avoid breakage and accidents and to extend the life of your bits and blades.

- ALWAYS** feed the work against the rotation of the knives.
- ALWAYS** be sure your workpiece is completely supported, before and after the cut.
- NEVER** remove guards or any other safety devices from your shaper.
- NEVER** use dull or damaged knives.
- NEVER** force the cut or overload the shaper.
- NEVER** change cutters or knives or make adjustments with the shaper plugged in.
- NEVER** make adjustments to the shaper while the cutter is turning.

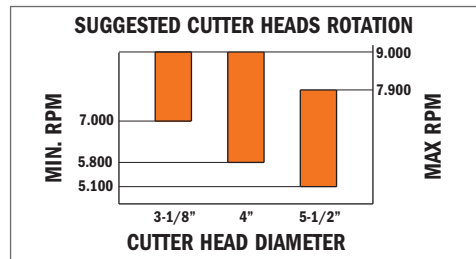

### CALIFORNIA PROPOSITION 65:

In 2016, the State of California amended its Safe Drinking Water and Toxic Enforcement Act, better known as Proposition 65. These amendments modified regulations related to required product warning labels. Proposition 65 requires that businesses operating in California, as well as businesses marketing products that may eventually find their way into the California marketplace, must provide "clear and reasonable" warnings to Californians about the presence of certain chemicals in the products they purchase.

CMT is taking a proactive stance in implementing these new product warning labels because our customers' well-being and safety is our top priority. Each and every CMT product that contains a chemical determined by the State of California to pose a risk of cancer, birth defects or other reproductive harm has been labelled with an updated warning on the product packaging. We thank you for your business and will continue with our commitment to safe, high-quality products.



**WARNING:** The products listed and described in this catalogue can expose you to chemicals including nickel, cobalt and formaldehyde, which are known to the State of California to cause cancer and lead, which is known to the State of California to cause cancer and birth defects or other reproductive harm. For more information go to [www.P65Warnings.ca.gov](http://www.P65Warnings.ca.gov).



**WARNING:** Drilling, sawing, sanding or machining wood products can expose you to wood dust, a substance known to the State of California to cause cancer. Avoid inhaling wood dust or use a dust mask or other safeguards for personal protection. For more information go to [www.P65Warnings.ca.gov/wood](http://www.P65Warnings.ca.gov/wood)

# What parameters should be considered when routing?

Answering the following questions will provide you with the answer!

- **What equipment is in use?** Using outdated machinery is not the same as using brand new high quality equipment! It is important to understand that phenomena such as vibration is the direct result of wear and tear, which can lead to a poor quality finish. In order to dampen vibration, feed rate is critical and quite often, higher feed rates are associated with better finishing results.
- **What factors influence bit performance?** Many factors affect performance and the ultimate finish of the workpiece: the power of the collet chuck, the rigidity and eccentricity of the couplings, conditions and quality of the collets, reverse locking system, sharpened tool edge, the dust collection system in use and even the relative humidity of the workplace environment.
- **Which is the best bit for the job?** The number of cutting edges as well as the cutting diameter significantly affect work parameters. In general, the more cutting edges and the wider the blade diameter, the higher the feed rate.
- **What is the desired cutting depth?** In order to increase cutting depth, it is necessary to reduce the feed rate and vice versa for shallower cuts.
- **What is the running speed of the machine in use?** By increasing the spindle speed (rpm), the quality of the finished edge improves. However, at the same time, friction also increases between the tool and the workpiece. As a result, tool longevity is compromised. Ideally, the objective is to select the slowest rotation speed possible compatible with the quality of finishing you hope to achieve.
- **What is the desired edge finish?** Coarse routing and fine routing are definitely not the same thing! You need to figure out what is more important: Quality or quantity. In order to prolong the life of your cutting tool, its best to choose the highest feed rate possible to achieve the finish you want.
- **What are the requirements and challenges of the materials you're working with?** Wood is a good example of natural fiber composite. It's naturally made up of a natural fibrous material, both elastic and flexible (cellulose: long molecular polymer chains), bound together by a very rigid substance (lignin: cross-linked polymer) as well as a compatibilizer (hemicellulose: a polysaccharide). It's an anisotropic material, that is, directionally dependent, implying different properties in different directions. How many types of wood and wood derivatives are you familiar with? Remember, no two pieces of wood are the same! In fact, the same work parameters carried out on two different pieces of wood will provide two very different results.

Feed rate is dependent of several factors, like the ones mentioned above - and these are just a few examples. It's important to weigh all factors in order to select an optimum feed rate suitable for the tools and work objectives involved. CMT is synonymous with quality and to produce high quality cuts you just can't randomly shoot off a bunch of numbers. Be wary of those who provide you with random numbers.

**I get it...but where do I start?** *The best way to go forward is step-by-step using reliable test data.* To quickly achieve the results best suited for your specific work expectations, you can always turn to theory! One rule of thumb, which may prove advantageous, is to use a simple gauge to measure chipload wherever possible. On the one hand, it should be noted that when chips that are too thick, breakage will occur, resulting in a poor, rough finish. On the other hand, when chips are too thin, it will negatively affect tool longevity and cause rapid wear and tear of the cutting edge because the teeth of the tool are rubbing more than removing material. The next time you experiment, you need to properly assess the specific demands of the work involved, assess chipload measurements and try to orient yourself towards a different thickness by taking into account the aforementioned factors. Then, with the aid of the formulas listed below, proceed to establish the appropriate feed rate for your next test. This will help you to achieve better results faster and you will have the essential information you will need for the next work project.

**PARAMETERS:**

- V = feed rate (m/min)
- Z = cutting edges
- C = Chipload (mm)

**FORMULAS:**

$V = (RPM \times Z \times C) / 1000$   
 $RPM = V \times 1000 / (Z \times C)$

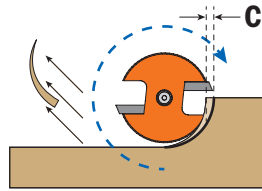

**EXAMPLE:**

with caliper take measurement of a good result chipload (C=0,2mm).

Z=2  
 RPM=18000

$V = (RPM \times Z \times C) / 1000 = (18000 \times 2 \times 0,2) / 1000 = 7,2 \text{ m/min}$

**PROBLEM SOLVING**

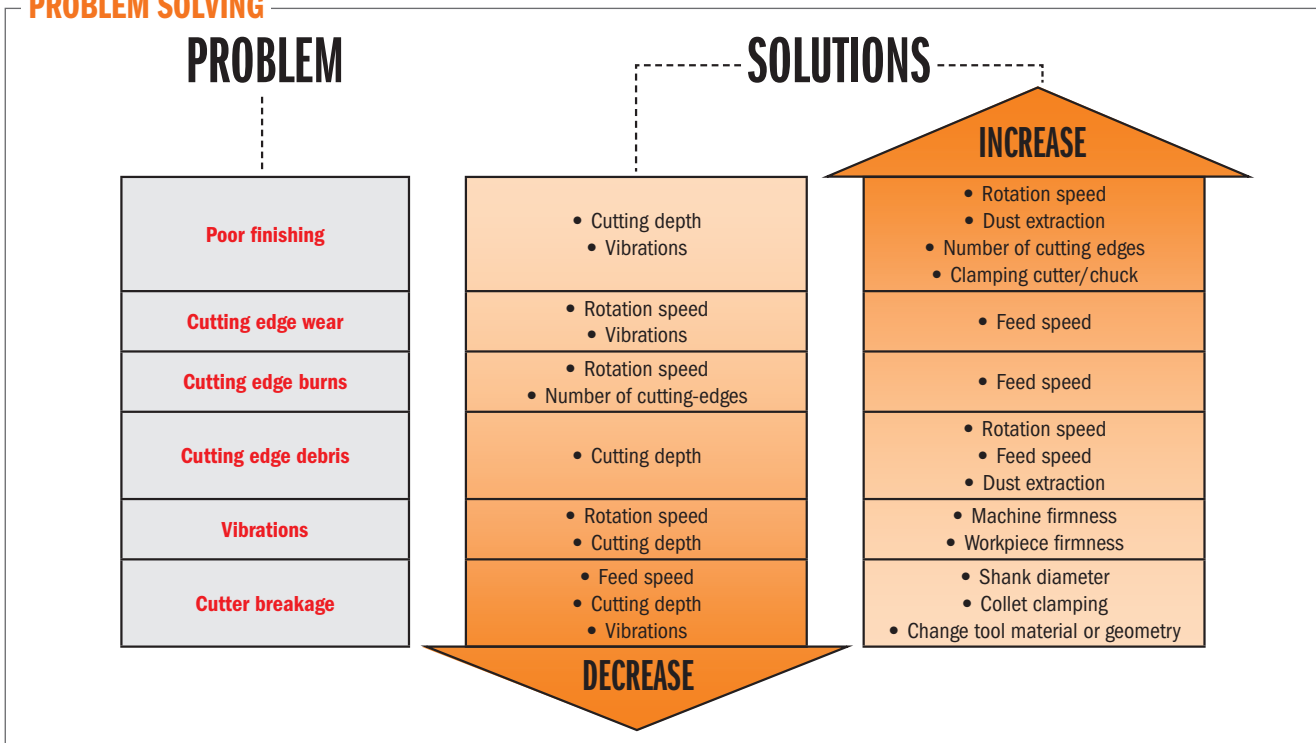



# Explanation of Symbols

CARBIDE TIPPED TUNGSTEN CARBIDE TIPPED	CARBIDE GRIT	SOLID CARBIDE	INSERT CARBIDE
SP ALLOYED TOOLS STEEL	HSS HIGH SPEED STEEL	HPS HIGH PERFORMANCE STEEL	HCS HIGH CARBON STEEL
HL HIGH-ALLOYED TOOL STEEL	HQ STEEL HIGH QUALITY STEEL PLATE	BIM 8% Co BIMETAL	BIM TIN TIN COATED BIMETAL WITH 8% COBALT TEETH
PCD DP POLYCRYSTALLINE DIAMOND	DIAMOND GRIT	TOOL WITH BEARING	2X CUTTING 4X CUTTING CUTTING EDGE
T1 ONE CUTTING EDGE	T2 TWO CUTTING EDGES	T3 THREE CUTTING EDGES	T4 FOUR CUTTING EDGES
T1+1 ONE + ONE CUTTING EDGES	T2+1 TWO + ONE CUTTING EDGES	T2+2 TWO + TWO CUTTING EDGES	T3+3 THREE +THREE CUTTING EDGES
T6+3 SIX + THREE CUTTING EDGES	T3R THREE CUTTING EDGES WITH CHIPBREAKER	V2 TWO SPUR	V4 FOUR SPUR
RH RIGHT-HAND ROTATION	LH LEFT-HAND ROTATION	LH RH RIGHT-HAND & LEFT-HAND ROTATION	AXIAL ANGLE
ANTIKICK-BACK	RADIAL RELIEF	TOOL WITH PLUNGING CAPACITY	SHEAR ANGLE GRIND
FLUSH TRIMMING	GROOVING, SIZING	REBATING, PROFILING, BEVELING	SPIRAL BORING
AVOID AXIAL PLUNGING	NOT FOR HAND HELD USE FOR ROUTER TABLE ONLY	SAW BLADE WITH DAMPENING SLOTS WITH FILL	SAW BLADE WITH DAMPENING SLOTS WITHOUT FILL
CARDBOARD BOX FOR SAW BLADES	CLAMSHELL CARRY CASE FOR SAW BLADES	PLASTIC BOX FOR ROUTER BITS	PLASTIC BOX FOR CUTTER HEAD
MEC MECHANICAL FEED	MAN MANUAL FEED	ORANGE CHROME®	NON-STICK ORANGE SHIELD® COATING
DLCS CHROME COATING	XTREME HIGH PERFORMANCE TOOL	CMT CONTRACTOR TOOLS®	WEAR SAFETY GLASSES
WEAR EAR PROTECTION	WEAR DUST MASK	WEAR SAFETY HELMET	WEAR FIVE FINGER GLOVES
WEAR SAFETY SHOES	HV10 HARDNESS VICKERS 10KG (HV10)	N/mm <sup>2</sup> TRANSVERSE RUPTURE STRENGTH (EXPRESSED IN N/MM <sup>2</sup> )	WARNING

# CMT HISTORY

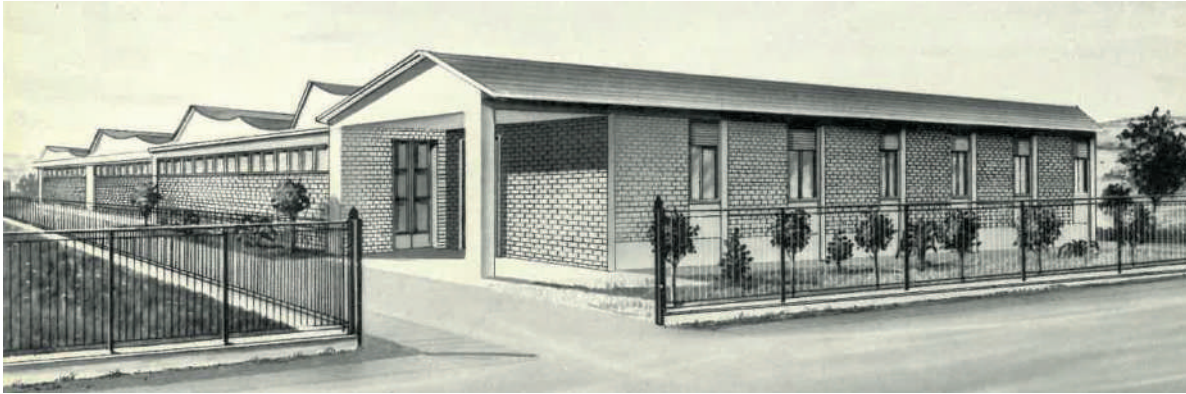
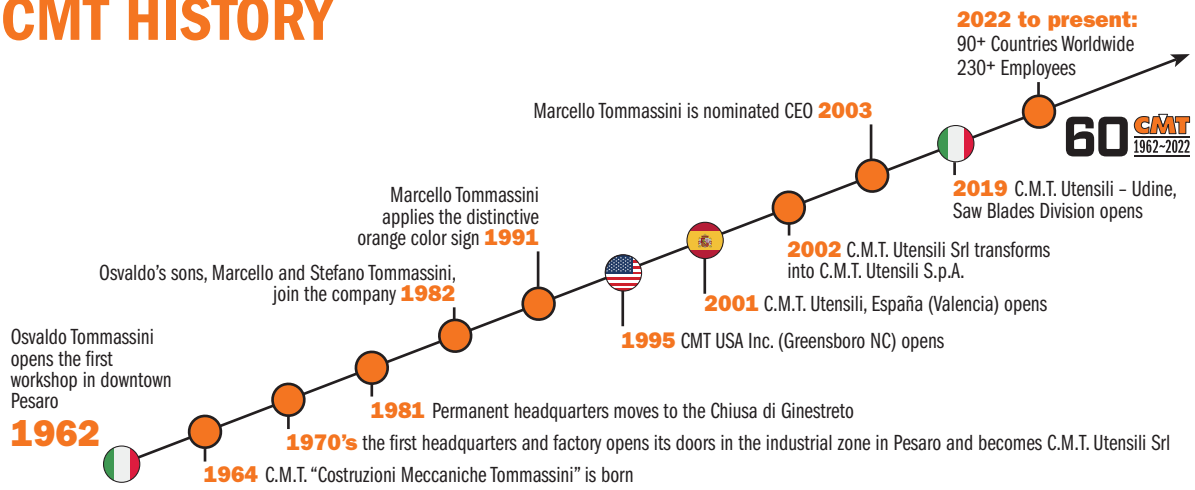

CMT headquarters in the 1970's

## CMT LOGO EVOLUTION

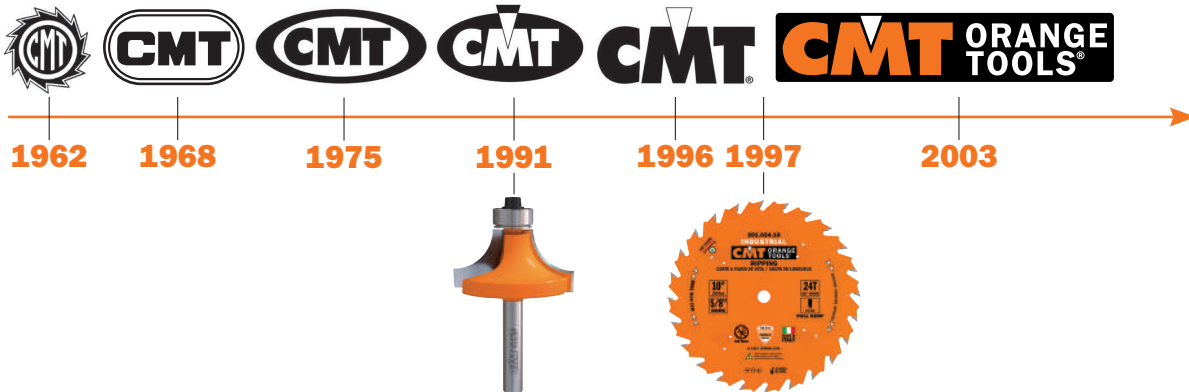

Hello there!

My name is **CMT ORANGE TOOLS**, I am the brand name of a dynamic Italian company which I am proud to tell you about. I was born in **1962** thanks to the initiative of my creator and company founder, Osvaldo Tommassini.

By the way, **CMT** stands for Costruzioni Meccaniche Tommassini. Over the years, my appearance has changed significantly.

In **1991** and **1997**, my two brothers (Bit and Blade) were born and following them, many others.

Orange by birth, together we make a great team and are synonymous with quality!

Today, after much hard work, our name has gone global so much so that our photo is registered in Trademark offices around the world.

Present in 90 countries around the world, our family has grown, the result of undying enthusiasm and above all, the color **ORANGE!**

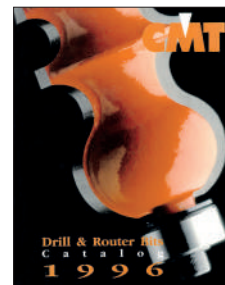

Our first catalogs

CMT HISTORY & LOGO EVOLUTION

## ONE-YEAR LIMITED WARRANTY:

1. CMT tools are designed, engineered and manufactured for optimum performance and service. If, for any reason, the first retail purchaser ("you") are not satisfied during the one (1) year period from the purchase date with the performance of the tools, and the tools were used only for their recommended application and in accordance with CMT's recommendations, you may return them to CMT for replacement. This Limited Warranty excludes normal wear and tear, dull, abused, misused, modified, damaged or resharpened tools. CMT shall not be liable for damages, including for damages to property or persons, arising out of improper installation, misuse or misapplication of tools.
2. ALL IMPLIED WARRANTIES FOR THE TOOLS, INCLUDING, BUT NOT LIMITED TO, ANY IMPLIED WARRANTIES OF MERCHANTABILITY AND FITNESS FOR A PARTICULAR PURPOSE, SHALL NOT EXTEND BEYOND THE LIMITED WARRANTY PERIOD SET FORTH ABOVE. Some states do not allow limitations on how long an implied warranty lasts, so the above limitation may not apply to you.
3. The remedy provided in paragraph 1 is your sole and exclusive remedy for all claims and causes of action arising out of or related to the tools. IN NO EVENT SHALL CMT'S LIABILITY, WHETHER IN CONTRACT, TORT, STRICT LIABILITY OR OTHERWISE, EVER EXCEED THE PURCHASE PRICE OF THE TOOL AT ISSUE.

## RETURNED TOOLS:

CMT will accept the return of tools that are defective or have been shipped in error. All returned tools must be accompanied by proof of purchase and a return authorization number, which must be obtained from CMT headquarters or a CMT authorized agent PRIOR to the return.

Other than tools shipped in error or for defective tools, if a return is authorized by CMT in its sole discretion, the following conditions apply:

### 1. A NEW ORDER IS PLACED TO REPLACE THE RETURNED TOOLS

- a. If the returned tools are ready to be restocked (no damages to the tools and packaging is in good condition), no charge will be applied.
- b. If the returned tools need to be repacked and/or relabeled, a 10% restocking fee will be applied.

### 2. NO ORDER IS PLACED TO REPLACE THE RETURNED TOOLS

- c. If the returned tools are ready to be restocked (no damages to the tools and packaging is in good condition), a 10% restocking fee will be applied.
  - d. If the returned tools need to be repacked and/or relabeled, a 20% restocking fee will be applied.
3. The shipper is responsible for paying transportation charges.
  4. Any approved return of inventory must be accompanied by an order in an amount at least equal to the net value of the credit.
  5. Written authorization must be obtained from CMT before the return will be accepted.

## GENERAL CONDITIONS:

CMT reserves the right to make from time to time changes to the tools without notice and without obligating itself to make these changes on previously sold tools. Title and risk of loss or damage to the tools passes to the Buyer upon delivery (and if shipped, upon delivery to the carrier regardless of who pays the shipping cost).

This warranty is not transferable. CMT expressly disclaims all other statements or representations of warranties, remedies, product quality or performance made by sales representatives, dealers, distributors, retailers, authorized agents, or in literature or documents given to Buyer. This warranty gives you specific legal rights, and you may also have other rights which vary from state to state.

## LIABILITY:

UNDER NO CIRCUMSTANCES SHALL CMT BE LIABLE FOR ANY CONSEQUENTIAL, INCIDENTAL, INDIRECT, PUNITIVE OR SPECIAL DAMAGES, INCLUDING LOST PROFITS, ARISING FROM THE USE OF, INSTALLATION OF, DEFECT IN, INABILITY TO USE, OR PROPERTY DAMAGE OR INJURY CAUSED BY THE TOOLS OR OTHERWISE. Some states do not allow the exclusion or limitation of incidental or consequential damages, so the above limitation or exclusion may not apply to you.

## DISPUTES:

To the extent allowed by law, Buyer consents to the exclusive jurisdiction of the state courts of North Carolina and federal district court for the middle district of North Carolina for the adjudication of all claims and disputes arising out of or related to the tools and waives any objection to venue or convenient forum with respect to said courts. This Limited Warranty and Procedures and the performance hereunder shall be deemed made and performed in the State of North Carolina, and the laws of that State of North Carolina (excluding conflict of law provisions) shall govern its interpretation, construction and enforcement.

**CMT USA, INC. 7609 BENTLEY ROAD SUITE D, GREENSBORO, NC 27409 PHONE 336-854-0201 FAX 336-854-0903**

© CMT, the CMT logo and the orange color applied to tool surfaces are trademarks of C.M.T. UTENSILI S.P.A.

© C.M.T. UTENSILI S.P.A.

*Any other brand names mentioned in CMT product catalogues and on the CMT website are the property of their respective owners.*

ADLER®	BUSELLATO®	DIVARIO®	FLEX®	HOLZMA®	MASTERWOOD®	PALFOAM™	SKIL®	VECTURO®
AEG®	CAPTO®	DOMINO®	FORMICA®	HOMAG®	MAYER®	PERLES®	SMART®	VELCRO®
ALBERTI®	CASALS®	DREMEL®	FOUNTAINHEAD®	HPS®	MEPLA®	PEUGEOT®	STARLOCK®	VERANDA®
ALTENDORF®	CERATIZIT®	DURALUMIN®	FREUD®	HUNDEGGER®	METABO®	PLEXIGLASS®	STARLOCKMAX®	VIRUTEX®
ALUCOBOND®	CHICAGO®	DUROPLAST®	GIBALTAR®	IMA®	MILWAUKEE®	POLYLAM®	STARLOCKPLUS®	VITAP®
ANUBA®	CHOICEDECK®	EIMA®	GRASS®	IVARPLANK®	MINI SPOT®	PORTER CABLE®	STAYER®	WEEKE®
AVONITE®	CMS®	EINHELL®	GRIGGIO®	KNOEVENAGEL®	MORBIDELLI®	PROXXON®	STRIPLOX®	WEGOMA®
AVEN®	CLAMEX®	ELU®	HÄFELE®	KRESS®	MULTIMASTER®	RIDGID®	SURELL®	WILSONART®
AZEK®	CORIAN®	ETERNIT®	HAFNER®	LAMELLO®	MULTITALENT®	ROCKWELL®	SWISSPEARL®	WOOD®
BALESTRINI®	COROPLAST®	ETHAFOAM®	HARDIEPANEL®	LEGNA®	NOTTMEYER®	RÖTHENBERGER®	TENSO®	WORX®
BIESSE®	CRAFTSMAN®	FATIGUE-PROOF®	HARDIEPLANK®	LEUCO® P-SYSTEM	NUOVA BULLERI	RYOBI®	TERSA®	WÜRTH®
BILEK®	CREMONES®	FEIN®	HETTICH®	LEXAN®	BREVETTI®	SALICE®	TIMBERTECH®	ZETA P®
BISCO®	DELRIN®	FELDER®	HILTI®	MAFELL®	OKITE®	SCHEEER®	TORWEGGE®	
BLACK & DECKER®	DENSIMET®	FELISATTI®	HITACHI®	MAGGI®	OMLAT®	SCHLEICHER®	TORX®	
BLUM®	DEWALT®	FERMACELL®	HOFFMANN®	MAKITA®	OZITO®	SCM®	TRESPA®	
BOSCH®	DIBOND®	FESTOOL®	HOLZ-HER®	MASTERCRAFT®	P-SYSTEM®	SILESTONE®	TREX®	

This document has been sent for your personal use only.

All usage and reproduction is forbidden without written permission from C.M.T. UTENSILI S.P.A.

[www.cmtorangetools.com](http://www.cmtorangetools.com)



**CMT USA, Inc.**  
7609 Bentley Road Suite D  
Greensboro, NC 27409

phone 336.854.0201  
fax 336.854.0903

[infocmtusa@cmtorangetools.com](mailto:infocmtusa@cmtorangetools.com)



Download this Catalog



Printed with 100% vegetable-based inks  
with a total Green Production Process  
certified UNI-EN ISO 14001



Order no. 03.60.3012 15K1023